

All COUPES

**NOV. '27 - JUNE '28 & AUGUST '29 - END OF '29 STANDARD
COUPE 45A**

1930 & 1931 STANDARD COUPE 45B STD

FEB. '30 - END '31 - DELUXE COUPE 45B DLX

JULY 1928 - JULY 29 - SPECIAL COUPE 49A

APRIL '28 - END OF '29 - BUSINESS COUPE 54A

1928 - 1929 SPORT COUPE 50A

1930 - 1931 SPORT COUPE 50B

Index	Page #
Books & Accessories	Coupe 2
Cowl Lights	Coupe 59
Dash & Dome Light	Coupe 71
Door Handles & Parts	Coupe 37
Drum Tail Light	Coupe 68
Fenders & Brackets	Coupe 15
Garnish Moldings & Frames	Coupe 73
Gas Gauge	Coupe 51
Gas Tank	Coupe 46
Glass Sets & Pieces	Coupe 28
Hood	Coupe 16
Insulation Kits	Coupe 45
Mirror	Coupe 57
Roll Down Window	Coupe 45
Rumble Parts	Coupe 21
Seat Parts	Coupe 75
Seat Springs	Coupe 77
Sheet Metal	Coupe 5
Sill Plates	Coupe 74
Spare Tire	Coupe 14
Speedometer	Coupe 53
Spring (Rear)	Coupe 21
Sun Visors & Panels	Coupe 11

Index	Page #
Tail Lights	Coupe 63
Top Parts	Coupe 33
Trunks	Coupe 3
Turn Signals	Coupe 70
Upholstery	Coupe 77
Window Shades & Brackets	Coupe 36
Windshields and Parts	Coupe 25
Windshield Wipers	Coupe 29
Wood	Coupe 12

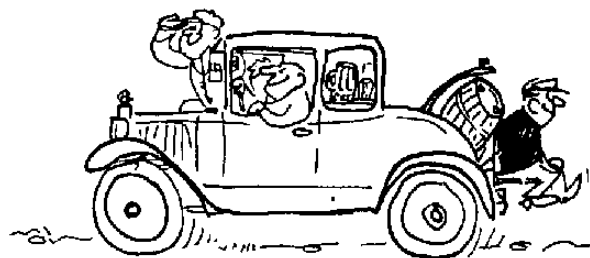

Joe, is it parts you need or the bathroom?

Mike's "A" FORD-ABLE Parts

Books & Accessories

Practical Information about 1930-1931 Coupes "A to Z"

175 Pages. A great "How to Book" for Coupe owners. Featuring many detailed articles and pictures of individual parts.

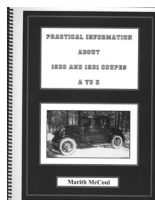

A91022 30-31 Price Ea. \$ 34.00

See "How to Restore your Model A - Vol. 5" Page 75 for information on restoring a 1930 - 1931 Sport Coupe and Page 55 for a 1928 - 1929 Sport Coupe.

Ford Color Prints - 12" x 18"

Beautiful prints of Made in America cars. Full color prints are from original paintings by Ford Motor Company illustrator Don Pacitti. You can order these prints with or without the Wood Grain finished frame with gold highlights. You can order these prints with or without the Wood Grain finished frame with gold highlights.

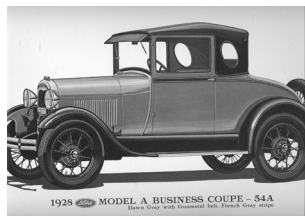

Prints ONLY

A91354 1928 Business Coupe - 54A
Price Ea. \$ 4.00

Framed Print

A91354F 1928 Business Coupe - 54A
Price Ea. \$ 18.00

Windwing Glass

This glass is cut to the original specs and is beveled. Sold in pairs only. The design is etched onto the glass with silk screen fired ceramic.



A68980 28-29 Coupe - 16" Tall
Price Pair \$ 41.95
A68980D 28-29 Etched Price Pair \$ 59.00
A61951 30-31 Coupe - 15 3/8" Tall
Price Pair \$ 39.95
A61951D 30-31 Etched Price Pair \$ 54.00

Windwing Clamps

These clamps are chrome plated for the windwing glass.



A18200C 28-31 Price Set/8 \$ 75.00

Car Covers

For indoor storage only. Poly cotton material.



C14702PD Coupe Price Ea. \$ 149.95

Coupe Key Fob

A wonderful gift idea. A silver plated brass key fob with a swivel feature that keeps the image always in view.



A18910 Price Ea. \$ 19.95

Wallpaper Border

A wonderful finishing touch for your office or shop. Pre-pasted vinyl wall paper strips. 15' X 7".



A18825 Passenger Border
Price Roll \$ 10.50

"Model A Crossing" Sign

A Unique gift for the model A lover in your life. Would be great above a work bench or hanging up in the garage. These signs are yellow with black print. 19" x 19".

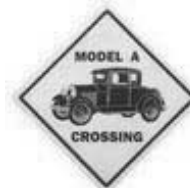

A18810 Coupe Sign Price Ea. \$ 17.50

Mike's "A" FORD-ABLE Parts

Trunks

This is a good quality, felt lined, trunk with all the hardware and leather straps. A locking key included.
13 x 34 x 20" High.



The Straight Back trunk is made for the Coupe.

A18574OB	28-31	Black	Price Ea.	\$ 350.00
A18574OT	28-31	Tan	Price Ea.	\$ 350.00

PLEASE NOTE: DUE TO THE SIZE AND WEIGHT OF THE TRUNKS THERE WILL BE AN ADDITIONAL SHIPPING CHARGE. PLEASE CALL FOR CURRENT PRICES.

See Page Gen. 17 for luggage Rack.

Trunk Straps

For mounting your trunk to the rack. 1" Wide by 72" Long. Nickel Plated Hardware. These are included with a new trunk. Need 2 per Trunk



A18574B	28-31	Black	Price Ea.	\$ 15.25
A18574T	28-31	Tan	Price Ea.	\$ 15.25

Trunk Boots

These will protect your trunk from the elements. It slips over the trunk and fastens with velcro. For trunks 12 3/4 d, 34 1/4 w, and 20"h.



A18575BSB	28-31	Straight backed Trunks - Black	Price Ea.	\$ 79.95
A18575TSB	28-31	Straight backed - Light Tan	Price Ea.	\$ 79.95

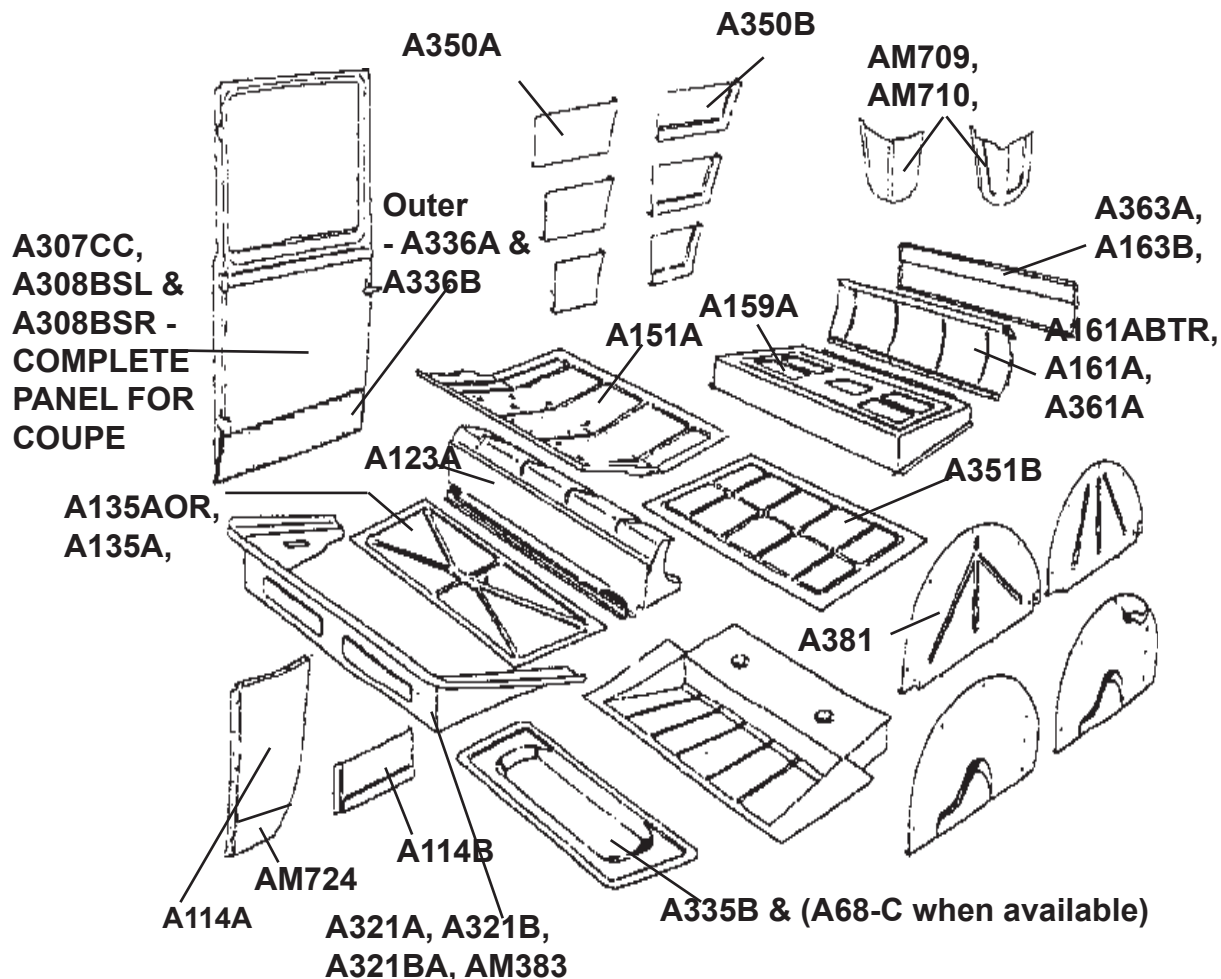

COUPE

IMPORTANT!!!!

It is important when fitting sheet metal to your car to FIRST fit before painting or drilling any holes. Many times it is necessary to use C-Clamps, vise grips or a pin to locate holes for alignment.

In order to secure a proper fit and alignment, it is normally necessary to loosen all attaching sheet metal parts. Some reworking may be necessary as mating parts may come from different suppliers or new parts versus 50 year old parts are placed together.

Some metal parts may have been treated with oil or many still have residue from forming oils. It is necessary to thoroughly clean the metal with a metal prep or solution to remove all oils and/or fingerprints before painting.

NO REWORKED OR PAINTED PARTS ARE ACCEPTABLE FOR RETURN.

Always Open 24/7 Shop Online at www.mikes-afordable.com

Coupe3

Mike's "A" FORD-ABLE Parts

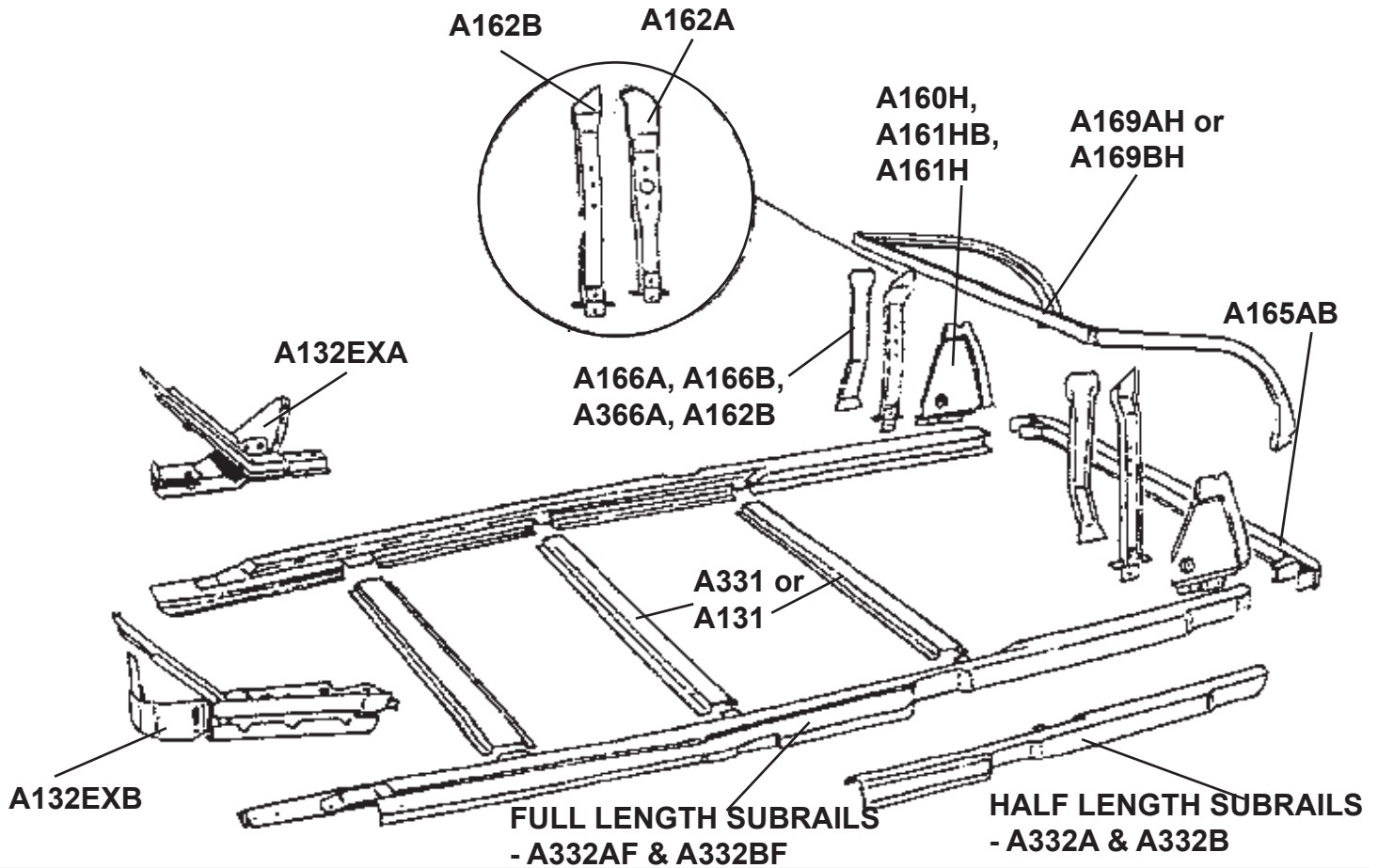

1928 - 1929 BODY PATCH PANELS

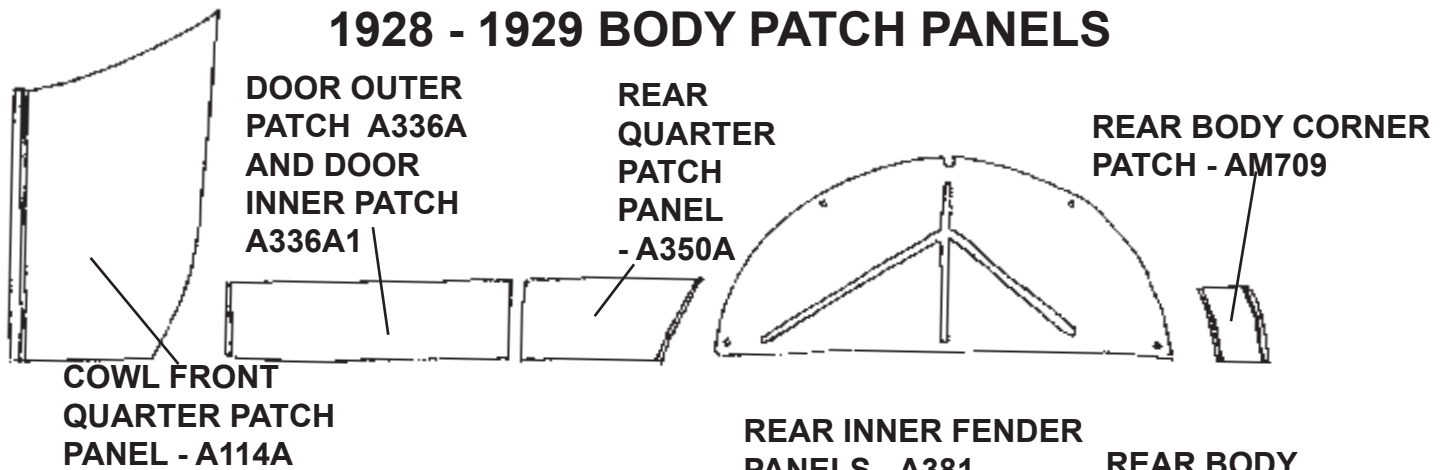

1930 - 1931 BODY PATCH PANELS

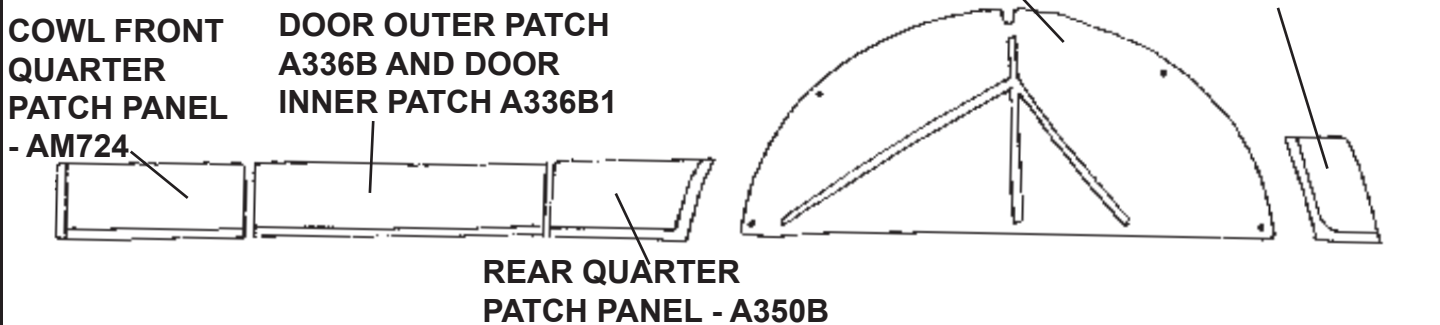

Sheet Metal

PLEASE NOTE: Due to the size of certain pieces of sheet metal additional shipping charges may apply.

Deck Lids

Mike has excellent steel rear deck lids with the D-nuts already attached for your hinges. For Coupes.



A1059AR	28-29	Steel - Rumble	Price Ea.	\$ 495.00
A1059BR	30-31	Steel - Rumble	Price Ea.	\$ 495.00



A1059AT	28-29	Steel - Trunk	Price Ea.	\$ 495.00
A1059BT	30-31	Steel - Trunk	Price Ea.	\$ 495.00

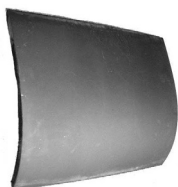

A1059ABS	28-31	Steel Rumble or Trunk Lid Skin	Price Ea.	\$ 200.00
----------	-------	--------------------------------	-----------	-----------

Deck Lid Inner Panels

Mike now has this Inner Trunk or Rumble Panel available for your Coupe.



A1059A1S	28-29	Rumble	Price Ea.	\$ 276.00
A1059B1S	30-31	Rumble	Price Ea.	\$ 276.00
A1059A1T	28-29	Trunk	Price Ea.	\$ 276.00
A1059B1T	30-31	Trunk	Price Ea.	\$ 276.00

Rear Outer Panel Below Deck Lid



A363A	28-29	Coupe 7 3/4" High	Price Ea.	\$ 46.00
-------	-------	-------------------	-----------	----------



A163B	30-31	Coupe 9 1/4" High	Price Ea.	\$ 46.00
-------	-------	-------------------	-----------	----------

Rear Outer Panel Below Deck Lid Screws

8 x 12/24 x 5/8" Pan Head Screws and Lockwashers



A80163X	28-31	Price Set/16	\$ 1.60
---------	-------	--------------	---------

Rumble Seat Compartment Curved Inner Panel

When converting from a trunk to a Rumble Seat, this panel is needed. The top of this panel, mounts to the panel below deck lid, with a maximum height of 14 1/4" and the bottom sits on top of the rumble platform on '30-'31 Coupe.



A161A	28-31	Price Ea.	\$ 40.00
-------	-------	-----------	----------



When converting a '28-'29 Coupe, to a rumble seat, maximum height of 12 1/8", use this panel.

A361A	28-31	Price Ea.	\$ 45.00
-------	-------	-----------	----------

Curved Inner Panel Screws

6 x 10/32 x 5/8" Oval for Top Edge.
8 x 1/4-20 x 1/2" Oval with Lock Washers and Square Nuts for the bottom.



A80161X	28-31	Price Set/30	\$ 1.90
---------	-------	--------------	---------

Mike's "A" FORD-ABLE Parts

Trunk Seat Compartment Curved Inner Panel

When you are converting from a Rumble to a Trunk on a '28-'31 Coupe, this panel is used by all Model A's using the Rumble as a trunk. All Required brackets are supplied.



A161ABTR 28-31 Price Ea. \$ 69.00

Spare Tire Brace

This brace supports the inside of the outer panel for the spare tire bracket. Can be used on '28-'29 panels, but must be shortened to fit.



A163ABR 28-31 Price Ea. \$ 21.00

Triangle Support Bracket

These attach to the curved inner panel. 9 3/8" High x 9 1/2" Long.

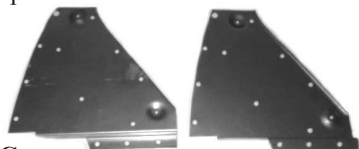

A160H 28-31 Coupe Price Pair \$ 59.95



Some Coupes came out with this style.

A161HB Price Pair \$ 59.95

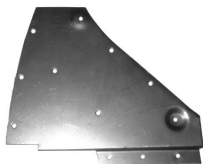

A161H 28-31 Sport Coupe Price Pair \$ 59.95

Rumble Hinge Brace

Your Rumble Hinge Mounting Bracket bolts to these Braces. 2 1/4" High and 18" Long.



A162A 28-29 Price Pair \$ 51.00

A162B 30-31 Price Pair \$ 51.00

Front Raingutter Support Bracket to Fenderwell Support or Compartment Braces.

For Trunk or Rumble - 3/12" Wide at top, 23" Long, and 2" Wide in the Middle.

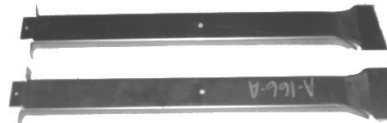

A166A 28- May 1931 Coupe Price Pair \$ 51.00

Front Raingutter Support Bracket to Fenderwell Support or Compartment Braces.

For Trunk or Rumble - 3 1/4" Wide at top, 17 1/2" Long, and 2" Wide in the Middle.



A166B Late '31 Coupe Price Pair \$ 51.00

Front Raingutter, Support Bracket to Fenderwell Support or Compartment Braces.



A366A 28-29 Coupe Price Pair \$ 46.00

Trunk or Rumble Seat Platform

Coupes used this panel even when installing a trunk.

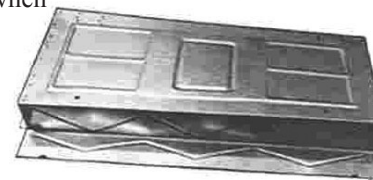

A159A 28-31 Original Design Price Ea. \$ 69.00

COUPE

Mike's "A" FORD-ABLE Parts

Trunk or Rumble Floor Pans

This is the piece that you would put your feet onto. Angled Style used with Seat Riser.

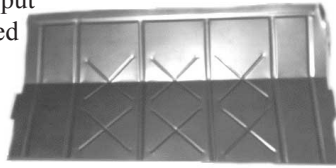

A151A 28-29 Coupe Price Ea. \$ 57.00

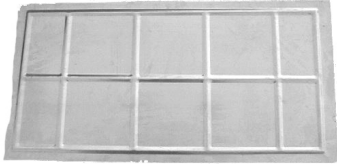

A351B 30-31 Coupe Flat Style - Ribs Face Up Price Ea. \$ 46.00

Rain Gutter Assembly

Used for Rumble or Trunk - You will have to weld together. Made in Sections for shipping purposes.



A169AH 28-29 Coupe Price Set \$ 190.00

A169BH 30-31 Coupe Price Set \$ 190.00



A169ATH 28-29 Upper Rain Gutter Trough - that goes from side to side Price Ea. \$ 81.00

A169ASH 28-31 Sides of Rain Gutter Price Pair \$ 98.00

A41517 28-31 Triangle Corners (This fits in each corner of rain gutter). 2 Needed. Price Ea. \$ 12.75



A169BTH 30-31 Upper Rain Gutter Trough (That goes from side to side). Price Ea. \$ 81.00

Front Seat Back Rest Riser

Back rest spring sits on this part. Not Required in '30-'31 Coupes.



A123A 28-29 Coupe Price Ea. \$ 63.00

Front Seat Riser

Mike also has these steel risers available which fit between the seat springs and the floor.



A321A 28-29 Coupe Price Ea. \$ 57.50

"U" shaped piece attaches to seat assembly.



A321B 30-31 Standard Coupe & Sport Coupe Price Ea. \$ 69.00

Metal ends. Wood center. Metal Toe Panel. Seat Track (A321BT) is not included. For wood - order A1511 - Back and A1510 Bottom.



A321BA 30-31 Coupe Seat Assembly Price Set \$ 295.10

Metal portion only. Complete with nuts and bolts.



AM383 30-31 Coupe Price Set \$ 133.29

Mike's "A" FORD-ABLE Parts

Panel Under Seat Frame

This goes under the Seat Riser and serves as a Floor Pan.

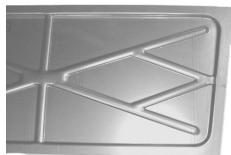

A135A 28-31 Coupe Price Ea. \$ 49.00



A135AOR This is the same as the A135A above, but die stamped to the original design Price Ea. \$ 55.20



A335B 30-31 Coupe Only Price Ea. \$ 63.00



(Not always available).

27 1/2" Long x 11 1/2" Wide x 2 1/2" Deep

A68C 1931 Late 1931 Coupe Price Ea. \$ 74.70

Body Channels

Your Floorpans attach to these.

48 1/2" Long.

Measurements are approximate.



A131 28-29 Coupe
1 x 3" x 3/4" Lips
2 x 2" x 3/4" Lips
Price Set \$ 65.00

A331 30-31 Coupe
1 x 4 1/2" x 3/4" Lips
2 x 2" x 3/4 Lips
Price Set \$ 52.00

Contoured Cowl Patch

A new correctly contoured patch has the compound curves of the cowl and also the correct beading.

Available only for '30-'31.



A014BD 30-31 Price Pair \$ 53.50

Cowl Quarter Patch Panels



A114A 28-29 Complete panel Price Pair \$ 114.00



AM724 28-29 Bottom 6" Panel Price Pair \$ 43.00



13 1/2" x 6" High
A114B 30-31 All Coupes Price Pair \$ 26.95

Door Bottom Outer Patch Panels



A336A 28-29 Coupe, Sport Coupe Price Pair \$ 49.95



A336B 30-31 Coupe Price Pair \$ 55.00

Door Bottom Inner Patch Panels



A336A1 28-29 Coupe - 25 3/8" x 4 3/4" Price Pair \$ 43.50

A336B1 30-31 Coupe - 23 5/8" - 4 3/4" Price Pair \$ 43.50

COUPE

Mike's "A" FORD-ABLE Parts

Rear Quarter Patch Panels



A350B 30-31 Coupe - Beaded Edge -
16" x approx. 6 1/2"
Price Pair \$ 46.00



Straight Edge - 16 1/2" x 6 1/2"
A350A 28-29 Coupe & Sport Coupe
Price Pair \$ 49.95

Rear Inner Fender Panels

Original style.

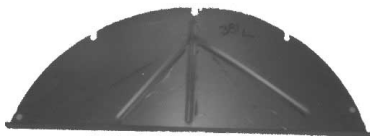

A381 28-31 Coupe -
14" High at Ctr x 33 1/2" Long.
Price Pair \$ 54.50

Rear Corner Patch Panels

Be Prepared to do some altering to fit -
Sorry, but these are the best available.



5- 6" Tall
AM709 28-29 Coupe Price Pair \$ 36.75

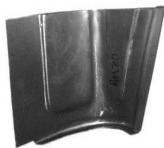

AM710 30-31 Coupe Price Pair \$ 36.75

Windshield Filler Trim - Steel



BWO-3031-LS 30-31 Price Ea. \$ 178.00

Subrails

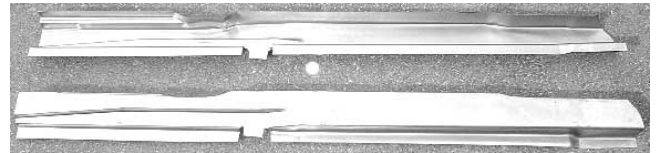

Rear half, from door back.
A332B 30-31 Coupe Price Set \$ 150.00

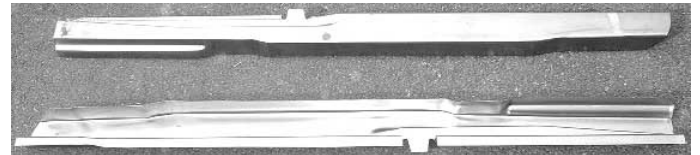

Rear half, from door back.
A332A 28-29 Coupe Price Set \$ 150.00



Full length.
A332AF 28-29 Coupe Price Set \$ 270.00



Full length.
A332BF 30-31 Coupe Price Set \$ 270.00

Subrail Extension - Floor Board Braces

Used on the Front of the Subrails for the Floorboards to mount
onto. 4 Pieces.



A132EXB 30-31 All body styles
Price Set/4 \$ 220.00



A132EXA 28-29 All body styles
Price Set/4 \$ 170.00

Mike's "A" FORD-ABLE Parts

Rear Sub Frame Channel (Rear Cross Member)

Fits below outer panel that ties the Sub Rails together at the back of the car. Includes D-Nuts to mount the Outer Panel and the Spare Tire.



A165AB	28-31	Coupe	Price Ea.	\$ 158.00
--------	-------	-------	-----------	-----------

Firewall - Original

Lower. Paint Lower Body Color.



A1015	28-29	Price Ea.	\$ 210.00
A1015B	30-31	Price Ea.	\$ 259.00

Recessed Firewall

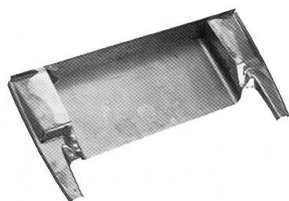

A1015AREC4	28-29	4"	Price Ea.	\$ 259.00
A1015AREC5	28-29	5"	Price Ea.	\$ 259.00
A1015BREC4	30-31	4"	Price Ea.	\$ 330.00
A1015BREC5	30-31	5"	Price Ea.	\$ 365.00

Cowl Top Panels

Made in the USA. Panel that replaces the Model A Gas Tank, filled style with no hole for the gas filler neck.



A117A	28-29	Price Ea.	\$ 290.00
-------	-------	-----------	-----------



A117B	30-31	Price Ea.	\$ 290.00
-------	-------	-----------	-----------

Hot Rod Upper Firewall

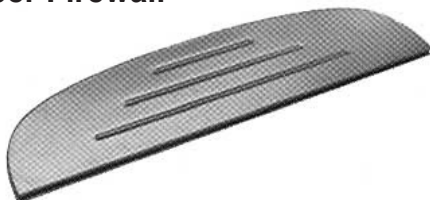

AF118F	28-29	Price Ea.	\$ 90.00
--------	-------	-----------	----------

Door Skins - Closed Cars

Die Stamped panels cover from the bottom of the door - up to the bead.



A307CC	28-29	Coupe	Price Ea.	\$ 68.00
A308BSL	30-31	Left	Price Ea.	\$ 78.00
A308BSR	30-31	Right	Price Ea.	\$ 78.00



Before and After

This 1930 Coupe has been in the Chaisson family since new. It was recently pulled out of the barn and a complete restoration done by Bentley 's Antique Auto Service.



1st Place Touring class -
Williamsburg, VA - 2007

Sun Visors & Panels

Sun Visors



A317A 28-29 Steel - Coupes
 Price Ea. \$ 57.75
 Originally these Visors were Covered - See Sun Visor Covers

Paint Body Color



A317BS 30-31 Steel - Coupes
 Price Ea. \$ 129.00

Visor Welt

Made in the USA. This goes between the Sun Visor and the Header and is 4' Long.



A3406VW 30-31 Price Roll \$ 1.25

Sun Visor Covers

Originally the '28-'29 Sun Visors were covered.
 Closed Car Only.

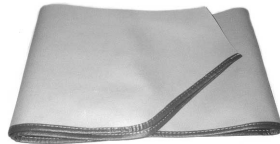

'28 - '29 Sport Coupe Only.

RSV4/1A	Tan Canvas	Price Kit	\$ 26.95
RSV4/2A	Black Canvas	Price Kit	\$ 75.95
RSV4/3B	Colonial	Price Kit	\$ 26.95
RSV4/4B	Cobra Short Grain	Price Kit	\$ 26.95

All other '28 - '29 Closed Cars
 RSV4/6 Cobra Long Grain
 Price Kit \$ 26.95

Sunvisor Screw Kit (Closed Car)

Oval wood screws and cup washers.
 4 Oval 10-32 x 5/8 metal screws,
 10- #10 x 3/4 Oval Wood Screws
 and 10- #10 cup Washers

A45390 28-29 Price Set/24 \$ 3.45



2-10-32 x 1/4 Flat hd machine scrw
 A45391 30-31 Price Set/2 \$ 0.95

Panel above Windshield

This panel fits above the windshield.
 3" Tall.



A174A 28-29 Coupe
 Price Ea. \$ 65.00

Panel under Visor

This is the panel that covers the front of the wood header inside the car and is used for the interior panel to set into. Some work may have to be done for a correct fit.



AM751 30-31 Coupes Price Ea. \$ 68.80
 AM752 28-29 Sport Coupe Price Ea. \$ 68.80

Header Cover

This is a steel panel that slips over the wood



header above the windshield on the Coupes. This may need some handwork as it is a handmade piece. Paint Upper Body Color.
 A174DS 28-29 Price Ea. \$ 145.00

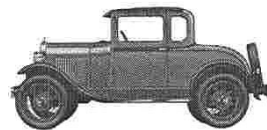

1928-29 STANDARD COUPE (45-A)

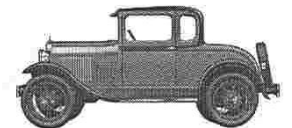

1928-29 SPECIAL COUPE (49-A)



1928-29 SPORT COUPE (50-A)



1928 BUSINESS COUPE (54-A)

COUPE

Mike's "A" FORD-ABLE Parts

Wood

Welcome to Mike's Wood Section. We have a complete selection of wood available for all Coupes, made out of the finest wood available. Each Piece is custom made to fit exactly like it was originally made using top quality hardwoods - oak, ash or poplar. We do not stock these items, they will be shipped directly from the manufacturer - separate shipping charges will apply.

UNFORTUNATELY DUE TO THE AMOUNT OF RETURNS INDIVIDUAL WOOD PIECES ARE NO LONGER AVAILABLE.

***** MIKE'S TIPS *****

If you are having a problem with your Doors, or your Hood will not line up with your Radiator Shell and Cowl - additional Shimming is required, usually under the cowl section. Align the hood first, then work back.

Top Wood - All of the wood from the top of the doors up.

Ribs - These go across the roof and support the top.

Belt Rail - Around the edge of the body where the top meets the body.

Body Wood - Structural Wood inside the body - Does NOT include Chassis wood, Belt Rail or Door wood, unless specified.

Headers - Wood above the windshield - Always included in the Top Wood Kits.

Coupe Body Mount Blocks

If your car has wooden sub rails, you don't need these! They go between the steel sub rails and the frame. Complete set per car. Don't forget to order your body block pads A5000P, A5001P and/or Cowl Shims A5002P.



Instructions are included.

AWD1005

28-29

Price Set \$ 29.50

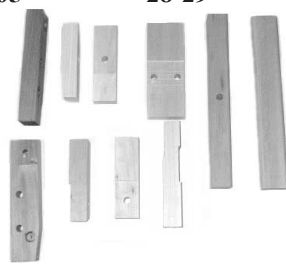

AWD1016

30-31

Price Set \$ 29.50

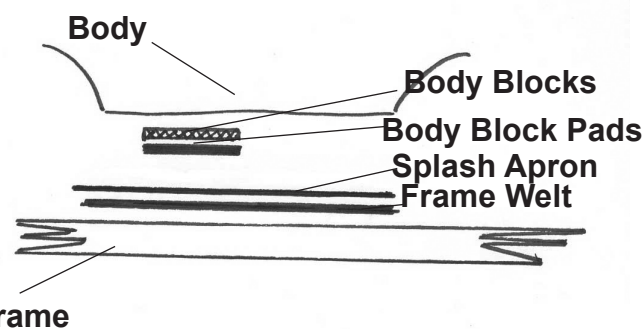

Coupe Body to Frame Mounting Bolt Sets

Body to frame bolts were different for each year and body style car. These complete kits come with complete instructions.



A90402

28-29

Price Set/46 \$ 9.00

A90403

30-31

Price Set/46 \$ 8.00

Coupe Dome Light Wood Block

This wood block fits between the roof ribs to mount the dome light onto.



A13720

30-31

Price Ea. \$ 9.50

Mike's "A" FORD-ABLE Parts

Coupe Latch Wood - Door Lock Cover

This is the latch wood that is mounted vertically about halfway up the door post. Originally this was made of hard rubber.



AWD1288-3	30-31 All Coupes		
AWD1287-8	28-29 Standard Coupe		
AWD1286-12	28-29 Special Coupe		
AWD1284-5	28-29 Sport Coupe		
		Price Pair	\$ 15.40

Coupe Headers

AWD1025-1	28-29	Coupe 45A, 49A, 50A, 54A,	
			Price Ea. \$ 68.00
AWD1031-1	30-31	Coupe 45B & Sport Coupe 50B	
			Price Ea. \$ 89.50

Coupe Top Wood Kits

Includes Header. Everything above the door opening.

AWD1028	28-29	Standard Coupe 45A	
			Price Kit \$ 283.00
AWD1029	28-29	Special Coupe 49A	
			Price Kit \$ 283.00
AWD1030	28-29	Business Coupe 54A	
			Price Kit \$ 358.00
AWD1031	30-31	Standard Coupe 45B	
			Price Kit \$ 283.00
AWD1085	28-29	Sport Coupe 50A	
			Price Kit \$ 375.00
AWD1086	30-31	Sport Coupe 50B	
			Price Kit \$ 375.00

Coupe Body Wood Kits

Body Shell wood less Top, Chassis & Door Wood.

AWD1285	28-29	Sport Coupe 50A & Business Coupe 54A	
			Price Kit \$ 285.00
AWD1286	28-29	Special Coupe 49A	
			Price Kit \$ 530.00
AWD1287	28-29	Standard Coupe 45A	
			Price Kit \$ 282.00
AWD1288	30-31	Standard Coupe 45B	
			Price Kit \$ 282.00
AWD1295	30-31	Sport Coupe 50B	
			Price Kit \$ 265.00

Coupe Belt Rails and Tack Rails

These Belt and Tack Rails are included in the Body Wood Kits.

AWD1285-2	28-29	Sport Coupe 50A - 5 Pieces	
			Price Kit \$ 139.00
AWD1286-2	28-29	Special Coupe 49A - 5 Pieces	
			Price Kit \$ 139.00
AWD1295-2	30-31	Sport Coupe 50B - 5 Pieces	
			Price Kit \$ 139.00

Coupe Seat Frame Wood Kits

AWD1502	Late 1931	Coupe 45B & Cabriolet 68C Backrest	
			Price Ea. \$ 79.50
AWD1508	28-29	Coupe 45A, Cabriolet 68A & 68B & Sport Coupe 50A Fixed Seat - Front Cushion	
			Price Ea. \$ 76.50
AWD1509	28-29	Coupe 45A, Cabriolet 68A & 68B & Sport Coupe 50A Fixed Seat - Seat Back	
			Price Ea. \$ 76.50
AWD1510	30-31	Coupe 45B & Cabriolet 68B Seat Carriage Bottom Frame - Adjustable Seat	
			Price Ea. \$ 76.50
AWD1510-B	30-31	Coupe 45B & Cabriolet 68B Seat Spring Frame - Adjustable Seat	
			Price Ea. \$ 76.50
AWD1511	30-31	Coupe 45B & Cabriolet 68B Backrest	
			Price Ea. \$ 79.50

Coupe Roll Down Rear Window Wood

A91202	30-31	Coupe Roll Down Rear Window Wood	
			Price Set \$ 97.00

Coupe Wood Kit Bolt Sets

Complete Bolt set for wood sets. A limited selection available at the moment, but more will be following soon.

Coupe Top Wood Bolt Set

312 Piece Set			
AWD-1031-KIT	30-31		Price Set \$ 25.50

Coupe Body Wood Bolt Set

222 Piece Set			
AWD-1288-KIT	30-31		Price Set \$ 23.95

Mike's "A" FORD-ABLE Parts

Body Nails

Commonly used on all Model "A's"

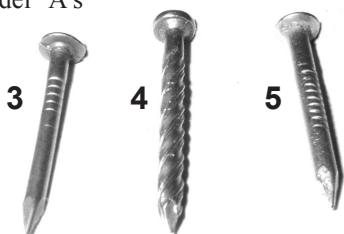

Nail Style #3

.074 diam. x 3/4" long - oval head - pack of 100

Price Pack \$ 1.50

Nail Style #4

Top Mouldings & Rain Gutter - .085 x 7/8" long - pack of 100

Price Pack \$ 1.50

Nail Style #5

Use these where rusting could occur - Stainless Steel .085x 3/4" long - pack 100

Price Pack \$ 3.00

Roof Tacks

This is a set of 100 zinc plated tacks used to tack the black vinyl decking to the wood top frame. The top molding covers these tacks.



A38425MBR 28-31 Price Pack \$ 2.25

Order Online Now and Save 5%

Visit our website for all your Model "A" needs.



www.mikes-afordable.com

Spare Tire

Only Coupe specific items are listed here, for more Spare Tire related items and accessories see page Gen. 39.

Rear Spare Tire Carrier

Carrier for the Coupe. Cast aluminum. Studs included. Paint black.



A1379AR	28-29	Price Ea.	\$ 47.50
A1379B	30-31	Price Ea.	\$ 47.50

Rear spare Wheel Mount to Body Bolts

The bolts for the Rear Spare Tire Carrier above.



A1379AMB	28-29	Price Ea.	\$ 2.10
A1379BMB	30-31	Price Ea.	\$ 2.50

Spare Tire Support

Used on the rumble seat of the Coupe with a rear mounted spare tire. Contoured to follow the curved inner panel. The top bolt on the carrier goes through the hole at the bottom.



A1401	30-31	Price Ea.	\$ 7.10
-------	-------	-----------	---------

Spare Tire Brace

This brace supports the inside of the outer panel for the spare tire bracket. Can be used on '28-'29 panels, but must be shortened to fit.



A163ABR	28-31	Price Ea.	\$ 21.00
---------	-------	-----------	----------

Rear Spare Wheel Tire Stud

Used on the Coupe, bottom stud only, the top two are the A1448 (Side Spare Wheel Tire Carrier Bolt) see page Gen. 39.



A1449	28-31	Price Ea.	\$ 1.65
-------	-------	-----------	---------

COUPE

Rear Fenders & Brackets

As front fenders are generic to all Model A's they are still in there own Section - See Page Gen. 199 & Gen. 200 For Front Fenders

Open and Closed Cab Rear Fenders Please read carefully before purchase.

Fiberglass Fenders - A complete line of fiberglass fenders are available. These are all hand laminated with fiberglass matte and special resins to achieve the optimum in strength.

Please Note: Additional shipping will apply due to large boxes. These are special orders, please allow three to four weeks for delivery. Rear fenders will be shipped by courier and are charged according to the box size.

Steel Fenders - It is important when fitting sheet metal to your car to FIRST fit before painting or drilling any holes. Many times it is necessary to use C-Clamps, vise grips or a drift pin to locate holes for alignment. In order to secure a proper fit and alignment, it is normally necessary to loosen all attaching sheet metal parts. Some reworking may be necessary as mating parts many come from different suppliers or new parts versus 80 year old parts are placed together. Some metal parts may have been treated with oil or may still have residue from forming oils. It is necessary to thoroughly clean the metal with a metal prep or solution to remove all oils and / or fingerprints before painting.

NO RE-WORKED, RUSTED OR PAINTED FENDERS ARE ACCEPTABLE FOR RETURN.

Coupe Rear Fiberglass Fenders:

1928 - 1929

F16161A	Left	Price Ea.	\$ 199.00
F16160A	Right	Price Ea.	\$ 199.00

1930 - Early 1931

F16161B	Left	Price Ea.	\$ 199.00
F16160B	Right	Price Ea.	\$ 199.00

Coupe Rear Steel Fenders:

These are very well-made reproductions using the same gauge steel as Ford used.

**Please read the instructions above.
THESE ARE SOLD IN PAIRS ONLY!**



A16160/61A	28-29	Left & Right	Price Pair	\$ 520.00
A16160/61B	30-31	Left & Right	Price Pair	\$ 520.00

Rear Fender Bracket

Here are the pressed steel rear fender brackets for the Coupes.



A16180A	28-31	Price Ea.	\$ 24.70
---------	-------	-----------	----------

Rear Fender Bracket Bolts

This set of bolts and castle nuts will attach both rear fender brackets to the body.



A16181MB	29-31	6 5/16" - 24 x 1" + l.w & nuts	Price Set/10	\$ 2.50
----------	-------	--------------------------------	--------------	---------

Rear Fender Washers & Nuts

If your studs (A081MB) are OK, then this set of 8 Flat Washers, Lockwashers and 5/16-18 Nuts are used to mount rear fenders to body.



A16195	29-31	Price Set/24	\$ 1.50
--------	-------	--------------	---------

Rear Fender Mount Studs

These are the special oversized head bolts that get welded or brazed to the body to mount the rear fenders on.



A081MB	28-31	4 studs needed per fender	Price Ea.	\$ 0.50
--------	-------	---------------------------	-----------	---------

Fender Welt

Mike has this 17 foot roll of the 3/16" black beading used on the fenders.



A3404FW	28-31	Price Ea.	\$ 9.90
---------	-------	-----------	---------

Rear Bumper Brackets

These brackets extend from the frame to mount the rear bumper. The stands come attached. This bracket is bolted UNDER the top of the frame, approx. 6" in front of the rear crossmember.



Use the A17779X Rear Bumper Bracket to Frame Bolts.

A17777C	28-31 Coupes including 5 1/4" stands	Price Pair	\$ 125.00
---------	--------------------------------------	------------	-----------

A17830C	28-31 Coupes Stands ONLY 5 1/4"	Price Ea.	\$ 11.50
---------	---------------------------------	-----------	----------

Rear Bumper Bracket to Stand Rivets

If you need to replace the stands here are the rivets that you will need.



RA1005	Price Ea.	\$ 0.80
--------	-----------	---------

Mike's "A" FORD-ABLE Parts

Hood

Hood Handle

These are pressed steel handles which mount in the middle of the side panels to lift the hood.

Rivets Included.

Use Rivet Tool **RA2022** on Page Gen. 28.

A16609 28-31 Price Pair \$ 24.95

Comes with **A16755** Modern Rivet Style

A16609SS 28-31 Stainless Price Pair \$ 30.75



Hood Latch Brackets

This is a complete set of brackets and hardware that the hood latch hooks onto. Use rivets **A16753**.

If you are using rivets, use Rivet Tool **RA2022** on Page Gen. 28.

A16750CL 28-31 Price Set/16 \$ 4.95

Comes with **A16753** Original Rivets, or you can order **A16755** Modern Style separately.

A16750HCSS 28-31 Stainless Price Set/16 \$ 12.05



Hood Handle & Latch Clip Rivet Set

Original style rivets for the hood handles and clip brackets. Use **RA2022** Rivet Tool on Page Gen. 28.

A16753 Price Set/20 \$ 2.00



Modern Style Hood Handle & Latch Clip Screw Set

These screws are used on the Hood Handles and Hood Clips - not original.

These are stainless round head screws with nuts that look like rivets from the outside. No riveting needed!!

A16755 Price Set/20 \$ 4.95



Hood Prop Kit

These stainless steel props are an important add-on for safety. The kit bolts onto the radiator braces and the fold out arms are rubber-coated to rest the hood on.

A16613SS 28-31 Price Kit \$ 24.95



Hood Safety Supports

Mounts on the hood rods, and hooks to hood rod bracket on firewall. When you raise the hood, set the bottom edge of the hood on the hooked end of the arm - protective plastic covers the wire. Set includes left and right side wire. Instructions included.



A16714A 28-29 Price Set \$ 21.95

A16714B 30-31 Price Set \$ 21.95

Early '28 Hood (All Early '28 Cars)

The early '28 hood louvres were all the same length. From mid '28 the top of the louvres on the side had a slight taper. Trophy Quality. Paint Underside Lower Body Color. Includes Handles **A16609** and Hood Clip Brackets **A16750CL** and Steel Hood Rods.



A16610AR 1928 Price Ea. \$ 405.00

1928-29 Stock Hood

This hood fits the '28-'29 Model A's. Trophy Quality. Paint Underside Lower Body Color. Includes Handles **A16609** and Hood Clip Brackets **A16750CL** and Steel Hood Rods.

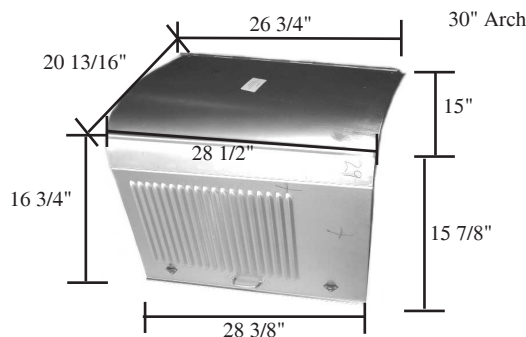

A16610A 28-29 Price Ea. \$ 380.00

1930-31 Stock Hood

All the '30-'31 Model A's used this hood. Trophy Quality. Paint Underside Lower Body Color. Includes Handles **A16609** and Hood Clip Brackets **A16750CL** and Steel Hood Rods.

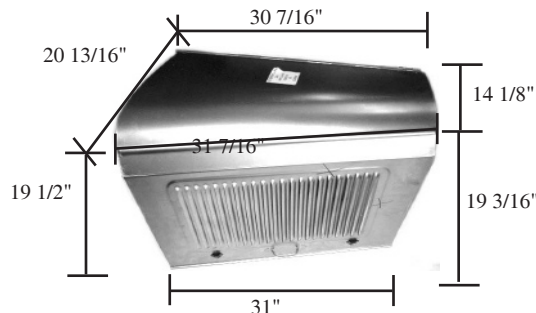

A16610B 30-31 Price Ea. \$ 420.00

Mike's "A" FORD-ABLE Parts

Stainless Hood Rods

Complete set of three hood rods. After punching these rods out about 1", use a variable speed drill, chuck it to the rod and spin the rod as you pull it out.

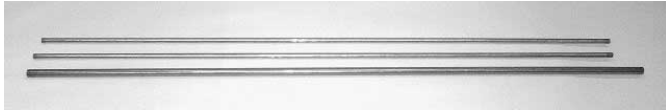

A16611A	28-29	27 3/4" Long	Price Set/3	\$ 14.95
A16611B	30-31	30 1/2" Long	Price Set/3	\$ 14.95

Hood Corners

Triangle leather hood corners originally were on the rear only. Use Rivet Tool RA2022 on Page Gen. 28. Rivets to be painted black.

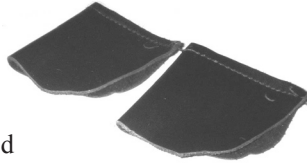

A16622LS	28-31	9/64 x 5/16 tubular rivets	Price Pair	\$ 3.90
----------	-------	----------------------------	------------	---------

Hood Corners

These are molded rubber hood corners; look good. Use Rivet Tool RA2022 on Page Gen. 28.



A16622RS	28-31		Price Pair	\$ 3.90
----------	-------	--	------------	---------

Hood Shelf

Not used on 1930-1931. See diagram on Page Coupe 18. Don't forget A16727S Blocks.



A16713/14	28-29		Price Pair	\$ 33.95
-----------	-------	--	------------	----------

Hood Shelf Blocks

These wooden blocks go under the hood shelf. They act as spacers to mount the hood latch.

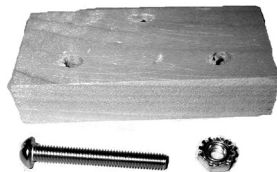

A16727S	28-29		Price Set/40	\$ 6.75
---------	-------	--	--------------	---------

Center Hood Bracket

Attaches to the frame with rubber bumper (A16761B - See Page Coupe 20) against the hood to prevent rattles.



A16718S	30-31		Price Set/12	\$ 5.50
---------	-------	--	--------------	---------

Hood Retainer (Front)

The center hood rod hooks onto this clip on the radiator shell. Paint Black



A8220C	28-31		Price Ea.	\$ 3.15
--------	-------	--	-----------	---------

Hood Retainer Mount Set (Front)

A pair of tube rivets to mount the center hood rod brackets. Use Rivet Tool RA2022 Page Gen. 28.



A8220MB	28-31		Price Pair	\$ 0.50
---------	-------	--	------------	---------

Hood Rod Retainer (Rear)

This is the rear retainer for the hood. Paint body color.

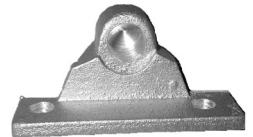

A16735A	28-29		Price Ea.	\$ 5.10
---------	-------	--	-----------	---------

Standard Hood Hinge Rod Retainer (Rear)

Same as above but for different years. Paint body color.

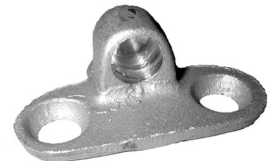

A16735B	30-31		Price Ea.	\$ 4.95
---------	-------	--	-----------	---------

Deluxe Hood Hinge Rod Retainer (Rear) Chrome

This serves the same purpose as A16735B, but has a finger which clamps over the cowl band. Normally only used on Deluxe '30-'31 Models. Order A16735BMB Screws - below.



A16735C	30-31		Price Ea.	\$ 8.75
---------	-------	--	-----------	---------

Retainer Mounting Screws (Rear)

Screws to mount the rear hood retainer to the firewall.



A16735AMB	28-29	2 x 12-24" x 5/8" round head	Price Set/6	\$ 0.95
-----------	-------	------------------------------	-------------	---------



A16735BMB	30-31	2 x 12-24" x 5/8" flat head	Price Set/4	\$ 0.95
-----------	-------	-----------------------------	-------------	---------

INSTALLATION OF HOOD SHELF
FOR 1928 - 1929 ONLY

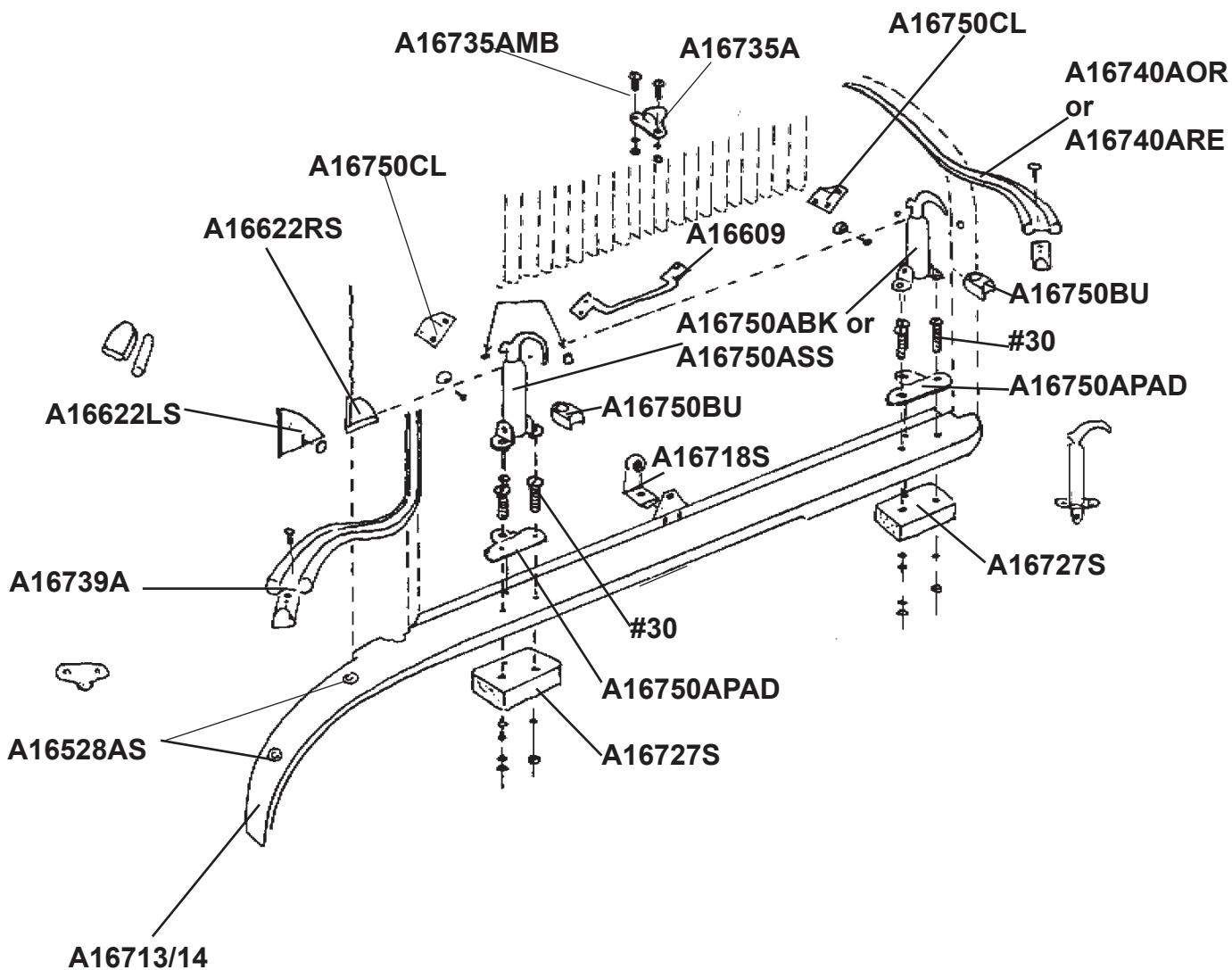

COUPE

Mike's "A" FORD-ABLE Parts

Hood Retainer Shims

Having alignment problems with your hood? Place these steel shims between the rear hood retainer and the cowl. Will help if the bottom of the hood is hitting on the radiator shell.

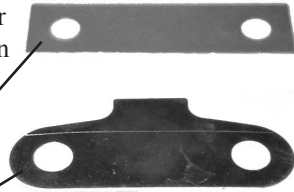

A16736A	28-29	Price Ea.	\$ 0.55
A16736B	30-31	Price Ea.	\$ 0.60

Cowl Band

This is a well made stainless steel reproduction. These '30-'31 reproduction bands will not fit the '28-'29's. These were usually painted black on all Commercial Trucks. Special box for UPS - additional shipping charges do apply.

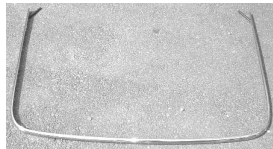

A16737CB	30-31	Price Ea.	\$ 73.00
----------	-------	-----------	----------

Cowl Band Clips

These clips go under the cowl panel screws on the firewall and slip under the cowl band to hold it in place.



A16738CL	30-31	Price Pair	\$ 3.35
----------	-------	------------	---------

Radiator Shell Lacing

This is a double beaded lacing for the radiator shell, comes with raven rivets.



A16739A	28-29	Price Set/25	\$ 6.75
---------	-------	--------------	---------

A16739B	30-31	Price Set/25	\$ 9.00
---------	-------	--------------	---------

Cowl Lacing Hook

This is the special hook that the wire attaches to, to hold the cowl lacing on. 10-32 x 3/4" Special Clamp Screw Used with original A16740AOR. Not included in lacing Kit A16740ARE or AOR.



A16739AC	28-29	Price Set	\$ 1.95
----------	-------	-----------	---------

Cowl Lacing Kit & Rivets

Two types are available for the '28-'29 A's. The original used wire to hold the lacing down on the gas tank and rivets on the cowl panels. Use Rivet Tool RA2022 on Page Gen. 28.



A16740ARE	28-29	Replacement	Price Kit	\$ 8.60
-----------	-------	-------------	-----------	---------

A16740AOR	28-29	Original	Price Kit	\$ 12.75
-----------	-------	----------	-----------	----------

Cowl Lacing Screws

Special pan headed replacement screws for installing the '30-'31 cowl lacing. Included in the cowl lacing kit (A16740BS). One for each side and the third top center. 3 x 12-24 pan head screws



A16740MB	30-31	Price Set/3	\$ 0.75
----------	-------	-------------	---------

Authentic Cowl Lacing Kit

Just like the original for '30-'31 A's. Complete with all clips, screws, and rivets. Use rivet Tool RA2022 on page Gen. 28.



A16740BS	30-31	Price Kit/10	\$ 15.45
----------	-------	--------------	----------

1930-31 Cowl Lacing Clip

Replacement clips for the '30-'31's if you've lost some. Included with kit A16740BS.

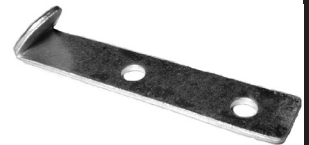

Use Rivet Tool RA2022 on page Gen. 28.

A16737	30-31	Price Ea.	\$ 0.75
--------	-------	-----------	---------

Cowl or Radiator Rivets

This is a package of 24 raven-finished split rivets to attach the hood lacing.



A16745	ANY	Price Set/24	\$ 1.20
--------	-----	--------------	---------

Hood Latch Repair Kit

If possible try to repair your original latch handles. Our set does all 4 latches and comes with complete instructions.



A16749	28-31	Price Set/12	\$ 12.50
--------	-------	--------------	----------

Hood Latch Handle

We have both the original black three-hole handles as well as stainless steel.



A16750ABK	28-29	Black	Price Ea.	\$ 8.25
-----------	-------	-------	-----------	---------

A16750ASS	28-29	Stainless - 3 Hole Mounting	Price Ea.	\$ 11.00
-----------	-------	-----------------------------	-----------	----------



#30	28-29	Hood Handle Screws	Price Set/36	\$ 2.25
-----	-------	--------------------	--------------	---------

Mike's "A" FORD-ABLE Parts

Hood Latch Pads

These 4 rubber pads go under the hood latches.



A16750APAD 28-29 Price Set/4 \$ 4.10



A16750BPAD 30-31 Price Set/4 \$ 4.10

Hood Latch Handle

We have both the original black two-hole handles plus modern stainless steel.



A16750BBK 30-31 Black Price Ea. \$ 8.25

A16750BSS 30-31 Stainless - 2 Hole Mounting Price Ea. \$ 11.00



#32 30-31 Hood Handle Screws Price Set/24 \$ 2.25

Hood Latch Rivet Kit

These tiny rivets connect the body of the hood latch to the mounting bracket. Use Rivet Tool RA2022 on Page Gen. 28.



A16751 28-31 Price Set/4 \$ 0.50

Hood Latch Caps

This set of 8 rubber caps protects your finish from being scratched. 1 Set will do all four handles.



A16750CS 28-31 Price Set/8 \$ 1.45

Hood Latch Bumper

Set of 4 rubber bumpers that fit over the hood latch stem to reduce rattles. This Latch bumper set cannot be used if you are using the Hood Bumper Set A16761 or A16761B.



A16750BU 28-31 Price Set/4 \$ 3.00

Hood Bumper Set

Complete set of 6 round rubber hood bumpers with rivets. Four for the hood and two for the centre hood braces. Place one under each hood clip plus one on each support clip.

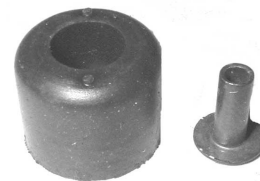

Use Rivet Tool RA2022 on Page Gen. 28.

A16761 28-31 from Aug 28 to May 31 Price Set/12 \$ 3.50

Hood Bumper Set

Complete set of 2 round rubber bumpers for the inside center support plus 4 triangular ones to go under each hood clip. The supplier ships with rivets which is correct, but Mike recommends using rivet head screws and nuts to keep them in place.



A16761B 1931 May 31 'til end Price Set/12 \$ 3.75

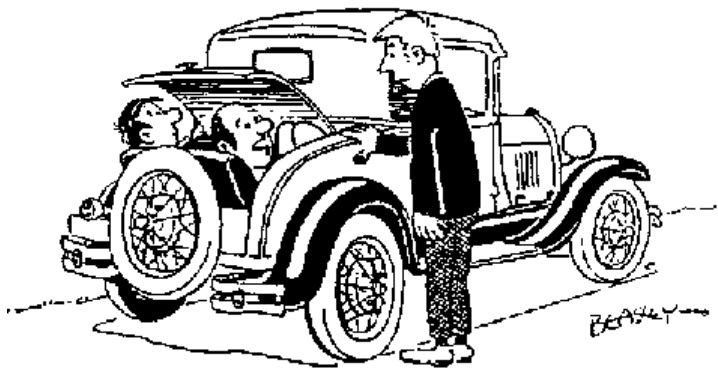

If you are going to Mike's - we are coming with you!!

Rear Spring

For more spring related items see page Gen. 99 of our general section.

Coupe & Sport Coupe Rear Leaf Spring

A good reproduction of the original.
Clamps NOT included.
For Clamps, bushings, Bolts and Nuts See Page Gen. 99 & 100.



A5560B 8 Leaf 28-31

Price Ea. \$ 215.00

**Shop online
and get a 5%
discount!!**

**This could cover
the cost of your
shipping!!**

**Just imagine -
FREE
SHIPPING!!**

Rumble Parts

Deck Lids

Mike has excellent steel rear deck lids with the D-nuts already attached for your hinges.



A1059AR	28-29	Steel - Rumble	Price Ea.	\$ 495.00
A1059AT	28-29	Steel - Trunk	Price Ea.	\$ 495.00
A1059BR	30-31	Steel - Rumble	Price Ea.	\$ 495.00
A1059BT	30-31	Steel - Trunk	Price Ea.	\$ 495.00
A1059ABS	28-31	Steel Deck Lid Skin	Price Ea.	\$ 200.00

Deck Lid Inner Panels

Mike now has this Inner Trunk or Rumble Panel available for your Coupe.



A1059A1T	28-29	Trunk	Price Ea.	\$ 276.00
A1059B1T	30-31	Trunk	Price Ea.	\$ 276.00
A1059A1S	28-29	Rumble	Price Ea.	\$ 276.00
A1059B1S	30-31	Rumble	Price Ea.	\$ 276.00

Rumble Floor Mat & Studs

Mike has the Rumble mats and studs available.
4 Piece Set.

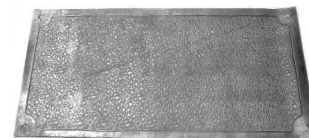

A2054	28-31	Mat	Price Ea.	\$ 34.95
A2057MB	28-31	Studs	Price Set/8	\$ 5.65

Rumble Stop Kit

This complete set fits all years. You will need to drill the holes in this. The upper part is aluminum while the lower is stamped steel. The part with the rubber stop is on the top and the other is used under the seat frame as a brace. 52 Piece Set.

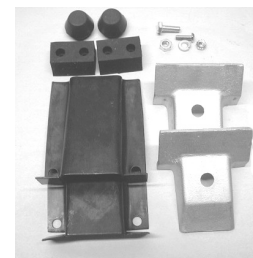

A41485CS	28-31		Price Set/52	\$ 19.00
----------	-------	--	--------------	----------

Mike's "A" FORD-ABLE Parts

Grab Handles / Top Rest Rail

Mike has these stainless steel handles which mount on each side of the rumble seat. The top rests on these when folded down. Screws and nuts supplied.



A41500SS 28-31 Price Pair \$ 36.85

Grab Handle Positions

1928 - 1929 Coupe

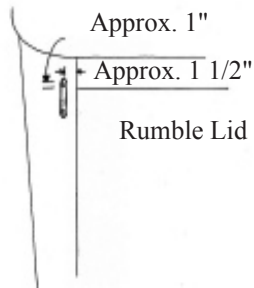

1930 - 1931 Coupe

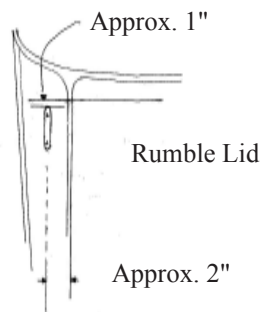

Top Rest Spacer Pads

A set of 4 thin rubber gaskets that are located on the bottom of the spacer to protect the paint.

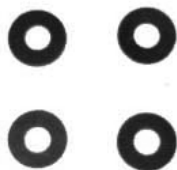

A41502 28-32 Price Set/4 \$ 0.70

Grab Handle Braces

These stamped steel braces go under the quarter panel for reinforcement where the handles mount.



A41500RB 28-31 Price Pair \$ 24.00

Grab Handle Screws

This is a set of 4 each screws, nuts, and lock washers to attach your rumble seat grab handles. Included with A41500SS.



#39 28-31 Price Set/12 \$ 1.75

Rumble Alignment Plates

These fit into the top corners of the rumble rain gutter to align the rear lid when you close it.

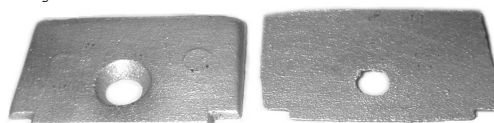

A41506 28-31 Price Pair \$ 3.45

Trunk Alignment Plates

These fit into the lower end of the trunk rain gutter to align the rear lid when you close it.



A41506TR 28-31 Price Set/8 \$ 6.25

Rumble Lid Bumper Set

Here is a complete set of rubber stops for the top and bottom of the rumble lid. Comes in Kit A41485CS.



A41484S 28-31 Price Set/4 \$ 3.95

Rumble Lid Bumper Bracket

These steel brackets go in the upper corner of the rumble rain gutter to hold the rubber stops. Need 2.

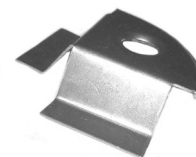

A41517 28-31 Price Ea. \$ 12.75

Rumble or Trunk Rubber Bumpers

This pair of rubber bumpers is used for either the upper corners of the rumble or the lower corners of the trunk. Comes in Kit A41485CS.



A41518 28-31 Price Pair \$ 1.75

COUPE

Mike's "A" FORD-ABLE Parts

Rumble Seat Hinge Kit

Here's all the hardware including hinges, braces, nuts, bolts, and lockwashers to mount the rumble seat. **Note:** 42 Piece Set.

A flat washer may be needed to shim between the hinge bracket and the deck lid.



A41543S 28-31 Price Set/42 \$ 31.95

Rumble Hinge Screws

This set of 12 screws is used to attach the rumble hinges to the rumble lid.



A41544MB 28-31 Price Set/12 \$ 1.80

Trunk Lid Hinges

You will need these hinges to mount your deck lid as a standard lift-up trunk. This is a quality USA Product and contains everything that you will need.



A41512S 28-31 Price Set/22 \$ 45.75

Rumble Hinge Pivot Bolts

This complete set of special shoulder bolts, square washers, and nuts is used where the rumble lid pivots. 38 Piece Set.



A41543MB 28-31 Price Set/38 \$ 6.95

Trunk Lid Support

If you've ever had a trunk come down on your head, you know how important this support is to hold up the deck lid.



A41530A 28-31 Price Ea. \$ 16.95

Trunk Lid Support Bolt Kit

The bolt kit needed to install the install the A41530A Trunk Lid Support.



A41530MB 28-31 Price Set \$ 5.45

Rumble Striker

If you're converting to a rumble, you need this type striker plate for the rumble lock.

7 Piece Set.

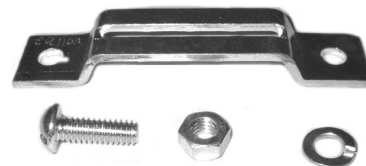

A52500S 28-32 Price Set/7 \$ 2.40

Trunk Striker

If you're using the rumble as a trunk, you'll need this to latch your lid.

10 Piece Set.

Screws Included.

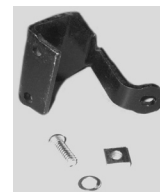

A41615 28-31 Price Set/10 \$ 6.00

Rumble / Trunk Lid Lock

This lock unit mounts inside the rumble lid.

'28 - '29 Rumble Lid

'28 - '31 Trunk Lid



A52501 28-31 Price Ea. \$ 14.25

Trunk / Rumble Handle Assembly

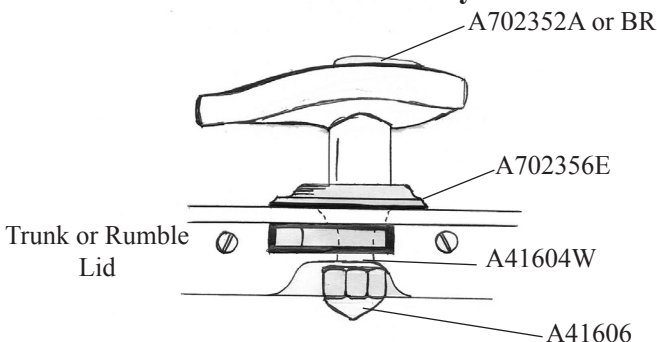

Rumble Lock

This lock unit mounts inside the rumble lid for the '30-'31's.

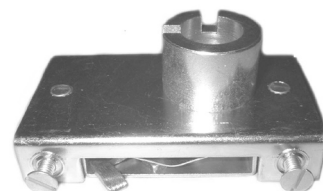

A52502 30-34 Price Ea. \$ 14.25

Rumble & Trunk Handle Lock Washer

This special type lock washer slides over the threaded shank and bends over the acorn nut A41606 when it's attached.

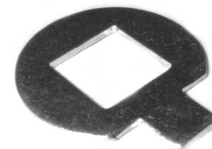

A41604W 28-31 Price Ea. \$ 0.70

Mike's "A" FORD-ABLE Parts

Rumble & Trunk Handle Acorn Nut

This is the special acorn nut that holds the rumble handle in place.



A41606 28-31 Price Ea. \$ 1.45

Rumble or Trunk Lid Handle

This chrome-plated locking rumble handle fits the Coupes.

Key Included.



A702352A 28-31 Price Ea. \$ 38.00

Rumble or Trunk Handle Pad

This is the rubber pad that fits between the rumble handle and the lid.



A702356E 28-31 Price Ea. \$ 0.50

Rumble Step Plate

This square step plate was used until 2/29. One goes on the fender and one on the bumper bracket.

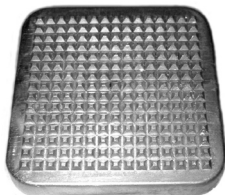

A41563S 28-29 Price Ea. \$ 7.60

Rumble Step Plate

This round cast aluminum step plate was used after 2/29. One goes on the fender and one on the bumper bracket.



A41563R 29-31 Price Ea. \$ 6.75

Rumble Step Plate Pads

These rubber pads have a good bead around the outer edge. Use one between the step plate and the fender.



A41563SP 28-29 Square Price Ea. \$ 2.25



A41564RP 29-31 Round Price Ea. \$ 2.05

Rumble Step Plate Bracket

This cast iron bracket bolts onto the bumper brackets for your rumble step plate.

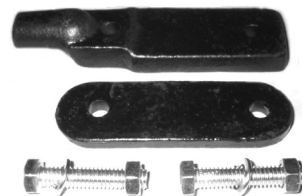

A41572 28-31 Price Set \$ 6.95

Complete Trunk to Rumble Seat Conversion for a 1930-1931 Car.

1 - A1059BR	Steel Deck Lids	\$ 495.00
1 - A41485CS	Rumble Stop Kit	\$ 19.00
1 - A41500SS	Grab Handles & Screws	\$ 36.85
1 - A41500RB	Grab Handle Brackets	\$ 24.00
1 - A41506	Alignment Plates	\$ 3.45
2 - A41517	Rumble Lid	
	Bumper Bracket \$ 12.75	\$ 25.50
1 - A41543S	Rumble Seat Hinge Kit	\$ 31.95
1 - A52500S	Striker	\$ 2.40
1 - A52502	Rumble Lock	\$ 14.25
1 - A702352A	Rumble Handle	\$ 38.00
1 - A702356E	Rumble Handle Pad	\$ 0.50
1 - A41604W	Lock Washer	\$ 0.70
1 - A41606	Acorn Nut	\$ 1.45
2 - A41563R	Rumble Step Plate \$ 6.75	\$ 13.50
1 - A41564RP	Step Plate Pad	\$ 2.05
1 - A41572	Step Plate Bracket	\$ 6.95
1 - A166A or B	Fenderwell Support	\$ 51.00
1 - A161A	Curved Inner Panel	\$ 40.00
1 - A162A or B	Hinge Brace	\$ 51.00
1 - A159A	Rumble Seat Platform	\$ 69.00
1 - A1401	Spare Tire Support	\$ 7.10
1 - S106 or S307	Rear Seat Cushion Spring	\$ 64.25
1 - S107 or S308	Rear Seat Backrest Spring	\$ 83.75
1 - UOC103RR31	Upholstery Kits - Page Gen. 220	\$
1 - KP52RR31	Rumble Panel Kits Page Gen. 229	\$
1 - A2054	Rumble Mat	\$ 34.95
1 - A2057MB	Floor Mat Studs	\$ 5.65

SHIPPING & UPHOLSTERY NOT INCLUDED IN PRICE
TOTAL \$ 1122.25

Please Note:

For '28 - '29, just follow the years advertised under each item. The above list is a guide line only. Give us a call when you are ready to go to work on your Trunk to Rumble Conversion.

See Mechanics Handbook - Vol. II for complete Instructions - Order A91029

Coupe Windshields & Parts

Coupe Windshield Frame

These windshield frames are good aluminum reproductions of the originals. They come with frame gasket Only. Hinge gasket may be needed. 1928-1931 Coupes.

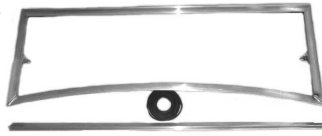

A45410AR	28-29 16 1/4" High	Price Ea.	\$ 180.00
A45410A	30-31 16 1/4" High	Price Ea.	\$ 180.00

Show Quality Coupe Steel Un-Finished Windshield Frame

This top quality frame comes with the correct swing arm brackets, frame gaskets, and assembly tools. **Right Hand**



drive is available upon request. Some sanding required.

28-5410U	28-29	Price Ea.	\$ 445.00
30-5410U	30-31	Price Ea.	\$ 445.00

Closed Car Windshield Frame Screws

When you need to replace the glass in your windshield you should take this opportunity to replace the screws in your windshield frame.



#47	28-31	Price Set/8	\$ 2.00
-----	-------	-------------	---------

Closed Car Windshield Frame Gasket

This gasket goes on the bottom (put in first) and sides of the steel windshield frame. Rubber gaskets stretch when you install them so wait a day to trim for a tighter fit.



A79500	26-31	Price Ea.	\$ 3.50
--------	-------	-----------	---------

Closed Car Windshield Frame Gasket (Aluminum Frame)

For the aluminum frame, this is the gasket to use. This does the bottom and both sides but wait a day to trim because of stretch.



A79501	28-31	Price Ea.	\$ 4.15
--------	-------	-----------	---------

Closed Car Glass Bedding

The correct cork / neoprene bedding to be used for setting the glass in the windshield frame.



A3403X	28-31	Price Roll	\$ 7.50
--------	-------	------------	---------

Closed Car Windshield Bracket

This bracket is an exact duplicate of the '28-'29 originals Includes rivets.



A45471A	28-29	Price Ea.	\$ 9.95
---------	-------	-----------	---------

Closed Car Windshield Bracket

This bracket is an exact duplicate of the '30-'31 originals for all Coupes. Includes Rivets.



A45471B	30-31	Price Ea.	\$ 9.95
---------	-------	-----------	---------

Closed Car Windshield Hinges

These aluminum hinges for the Coupes have to be drilled out and have tapers cut on the ends.

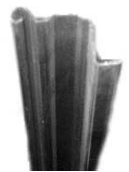

A45411AR	28-29	Price Ea.	\$ 11.30
A45411A	30-31	Price Ea.	\$ 11.30

Closed Car Windshield Hinge Gasket

This gasket is critical to keep out water. It fits between the windshield hinge and the header. The small round edge is exposed to the outside.



A79550	28-31	Price Ea.	\$ 3.00
--------	-------	-----------	---------

Closed Car Windshield Hinge to Header Screws

A complete set of screws to attach the hinges to the header on the Closed Cars.



A30200	28-29	6 1/4-20 x 1/2" round head screws, 4 10/32 x 3/8 flat, 2 10/32 x 1/2 Oval & 2 3/8 x 10/32 square Nuts.	Price Set \$ 1.80
--------	-------	--	-------------------

A30210	30-31	10 - #10 x 1" round head wood screws	Price Set \$ 1.00
--------	-------	--------------------------------------	-------------------

Closed Car Windshield Hinge Screws - Interior

5 - #10 x 3/4" flat head wood screws attach to inside of the windshield to secure the Windshield hinge to the header.



A30220	28-31	Price Set	\$ 0.50
--------	-------	-----------	---------

Mike's "A" FORD-ABLE Parts

Windshield Header Brackets

Use this metal bracket to connect the wood header to the side wood body rail.

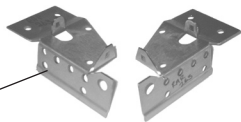

RAR263	30-31	Coupe - Std & Deluxe	
		Price Pair	\$ 39.50
RAR260		Early 30-31 Sport Coupe	
		Price Pair	\$ 25.95

Windshield Header Bracket Screws

8 - 5/16-18 x 2" flat head screws. Two screws go forward into the header and two at a right angle, into the wood side rail.

Also 6 - 12/24 x 5/8" flat head screws and 6 1/4" external, counter sunk lock washers to mount the brace to the vertical top.



A40130	28-31	Price Set	\$ 2.75
--------	-------	-----------	---------

Header Cover

This is a steel panel that slips over the wood header above the windshield on the **Coupes**. This may need some handwork as it is a handmade piece. Paint upper Body color.



A174DS	28-29	Price Ea.	\$ 145.00
--------	-------	-----------	-----------

Closed Car Windshield Garnish

This steel garnish screws to the windshield posts on both sides of the windshield opening on the closed cars.



A45483A	28-29	Steel - Coupe	
		Price Pair	\$ 46.50

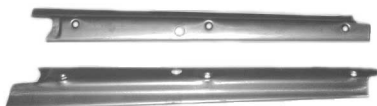

A45483	30-31	Steel - Coupe	
		Price Pair	\$ 46.50
A45483S	30-31	Stainless - Coupe	
		Price Pair	\$ 63.25

Garnish Molding Screws

These screws are 10/32 x 1/2" to attach the garnish molding to the door.



A342S	28-31	Price Ea.	\$ 0.15
-------	-------	-----------	---------

Filler Trim

This panel goes above the gas tank at the back edge on '30-'31's. The lower part of the windshield closes against this.



BWO-3031-LS	30-31	Price Ea.	\$ 178.00
-------------	-------	-----------	-----------

Closed Car Swing Arms

These are the arms that pivot to hold the windshield out for fresh air or close and seal the glass shut.



A45463S	28-31	Price Pair	\$ 9.95
---------	-------	------------	---------

Accessory Style Swing Arms

These arms have notches in them so that the arms are sure not to move or slide.

Once you use these you'll be hooked.

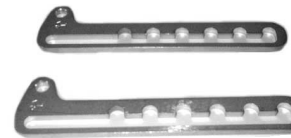

A45463N	28-31	Price Pair	\$ 29.95
---------	-------	------------	----------

Closed Car Windshield Frame Nut

This is the special nut that goes on the windshield frame to attach the swing arm to. Need 2.



A45475NUT	28-31	Price Ea.	\$ 1.45
-----------	-------	-----------	---------

Closed Car Pivot Bolt & Nut

This kit has the hardware to hold the swing arm to the windshield frame on both sides.



A45475S	28-29	Price Set	\$ 2.70
---------	-------	-----------	---------

The '30-'31's Windshields did not use sleeve nuts. The A45475NUT was used for nuts.



A45476B	30-31	Price Set	\$ 0.75
---------	-------	-----------	---------

Closed Car Swing Arm Washers

You need one set of these for your car. These are chrome cup-shaped washers with rubber inserts that go on the swing arms.



A45477S	28-31	Price Pair	\$ 2.50
---------	-------	------------	---------

Closed Car Swing Arm Nuts

These are the chrome-plated nuts that hold the swing arms in place when you open the windshield.

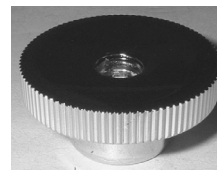

A45482	28-31	Price Pair	\$ 6.95
--------	-------	------------	---------

Mike's "A" FORD-ABLE Parts

Sunvisor Screw Kit (Closed Car)

Oval wood screws and cup washers.

4 Oval 10-32 x 5/8 metal screws,
10- #10 x 3/4 Oval Wood Screws
and 10- #10 cup Washers

A45390 28-29



Price Set/24 \$ 3.45

2-10/32x1/4Flat hd machine screw

A45391 30-31



Price Set/2 \$ 0.95

Visor Welt

This goes between the Sun Visor and the Header and is 4' Long.



A3406VW 30-31

Price Roll \$ 1.25

Installation of Swing Arms

A45475S - 28-29
A45476B - 30-31

A45477S on both side
of Swing Arms

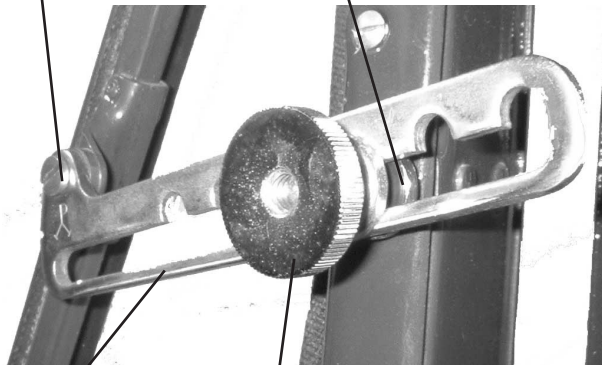

A45463N
or
A45463S

A45482

**Do you need a
discount on your
parts??**

**Shop online at www.mikes-afordable.com
and get a 5%
discount!!**

COUPE

Mike's "A" FORD-ABLE Parts

Glass Sets

PLEASE NOTE: All glass is clear AS1 safety glass 1/4" thick. This safety glass works very well and presents no fitting or installation problems. Your glass will be shipped by UPS in special boxes that will ensure safe delivery. Most shipments will be made within 14 working days of the receipt of your order and WILL require additional shipping charges. Shipping charges do apply to glass picked up at our store.

The following codes are used below to describe the glass:

W = Windshield D = Door Glass

Q = Quarter Glass B = Back Glass

Where "DD" appears it indicates 2 Door Windows, "QQ" indicates 2 Quarter Windows, ETC.

PLEASE MAKE SURE TO SPECIFY THE EXACT YEAR AND BODY STYLE OF YOUR CAR.

W, DD, QQ, B - Standard Coupe 45A
(Back Window is 23 11/16" x 10 11/16")
AG13A 28-29 Price Set \$ 346.50

W, DD, QQ, B - Special Coupe 49A
(Back Window is 23 1/2" x 10 1/2")
AG13B 28-29 Price Set \$ 346.50

W, DD, QQ, B - Standard Coupe 45B & Deluxe Coupe 45B
Del.
AG14 30-31 Price Set \$ 346.50

W, DD, QQ, B - Business Coupe
(Back window is 6 x 15.5")
AG15A 1929 Price Set \$ 346.50

W, DD, QQ, B - Business Coupe 54A
(Back Window is 8.5" x 19.5")
AG15B 1929 Price Set \$ 346.50

W, DD, B - Sport Coupe
(Back Window is 6" x 15.5")
AG16A 1929 Price Set \$ 258.50

W, DD, B - Sport Coupe 50A
(Back Window is 8.5" x 19.5")
AG16B 1929 Price Set \$ 258.50

W, DD, B - Sport Coupe 50B
AG17 1930 - 1931 Price Set \$ 258.50

Individual Glass Pieces

One Piece Windshield - Closed Car - SPECIFY
AGW1 28-31 Price Ea. \$ 121.00

Door Window - Any Body Style - SPECIFY
AGD2 28-31 Price Ea. \$ 72.60

Quarter Window - Any Body Style
AGQ3 28-31 Price Ea. \$ 72.60

Back Window - Any Body Style - SPECIFY
AGB5 28-31 Price Ea. \$ 58.30

Ford Script Logo Etched on Glass

1928 - 1929 Windshields for cars.



A94999A 28-31 Price Ea. \$ 16.50

1930 - 1931 Windshields for Cars
May 1931 thru 1931 all glass optional.



A94999C 30-31 Price Ea. \$ 16.50

COUPE

Windshield Wipers

Electric Wiper Motor

This is a universal 6-volt motor that mounts on the inside of the car. The shaft is sleeved and threaded to hold it in place. **Does not include wiper blade and arm.**

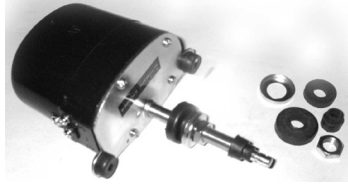

110 Degree Sweep.

Black Housing - With On - Off Switch. - 1928-1931.

The 6 Volt shaft can be adapted from the 3 1/4" to 2 1/2" if necessary. Unless you adapt the motor to go thru the windshield frame with an angled hole, you will not be able to open the windshield.

For arms and blades for this motor, we suggest **A17529A** or **A17529CHP** Arms (below) and **A17528** or **A17528B** Blades - (Page Coupe 30).

A17508E6 6 Volt - 3 1/4" Shaft Price Ea. \$ 41.25

A17508E12 12 Volt - 3 1/4" Shaft Price Ea. \$ 52.75

Electric Wiper Assembly

This is a polished stainless steel assembly **complete with arm and blade.** Really nice. Instructions are included for shortening shaft if required.



A17508SS6 28-31 6 Volt - 5" Shaft - No On-Off Switch
Price Ea. \$ 55.00

A17508SS12 28-31 12 Volt - 5" shaft - No On-Off Switch
Price Ea. \$ 54.95

Electric Wiper Connection

These connections are used on all the electric wipers to connect the wire to the wiper motor.



A17675 28-30 Price Ea. \$ 5.50

Electric Wiper Wire Kit

Replace your dirty, cracked wiper wire with this correct black and blue cloth-covered wire. It runs from the terminal box to the wiper motor and has the flag connector for the terminal box end.



A17500WK 28-31 Price Ea. \$ 3.75

Electric Wiper Wire Clip

You will need three of these to hold the wiper motor wire to the header on your Coupe.



A17616A 28-30 Price Ea. \$ 1.50

Wiper & Dome Light Wire Support

This clip was held in place by a bolt that held the gas tank to the cowl. It served as a grommet holder for the wiper and or dome lamp wire, and the other part of the clip held the top of the kick panel in place. Grommet included. 2 Required.



A14591 28-29 Price Ea. \$ 4.30

A14591GR Grommet Only Price Ea. \$ 0.70

Coupe Electric Wiper Wire Supports

You will need three of these for the Coupe to hold the wire which goes to the wiper motor plus to support the cowl light wire. Need 3 per Car.

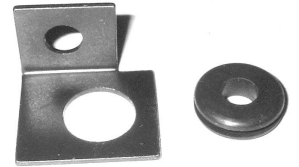

A14593A 28-29 Price Ea. \$ 2.25

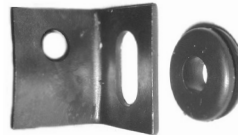

A14593 30-31 Price Ea. \$ 2.90

***** MIKES TIPS *****

Use only Replacement Blades with Replacement Arms and Show Blades with Show Arms.

Replacement Electric Wiper Arm - Closed Cab Pickup

If your wiper motor is mounted on the outside of the cab, this is the arm to use.



A17529A 28-31 Price Ea. \$ 3.75

Replacement Electric Wiper Arm (Generic)

If you've got the aftermarket **A17500-E6** motor, you will need this wiper arm. You can use the **A17528** or **A17528B** blade. This is a chopped (shorter) Arm also for Street rods.



A17529CHP 28-31 Price Ea. \$ 10.95

Mike's "A" FORD-ABLE Parts

Replacement Electric Wiper Blade

These wiper blades fit all Model A Replacement arms.



A17528 28-29 7-1/4" Blade
Price Ea. \$ 2.50

A17528B 30-31 8-1/4" Blade
Price Ea. \$ 2.75

Show Quality Electric Blades

8 3/4" Nickel Plated, Single Ply Blade with Cotter Pin Hole used on Early 1928 Closed Cars. Use A17565A Arm.



A17506A Early 1928 Price Ea. \$ 16.50

This is an exact duplicate of the original TRICO embossed blade for the cars with the original electric motor. 8 1/4" Nickel Blade with cotter hole - single ply rubber. Use A17565A Arm.



A17506B 1928 - April 1929 - Closed Cars
Price Ea. \$ 16.25

8 1/4" Nickel Plated, Contoured Top, Multi-Ply Blade with Cotter Pin Hole. Use A17565A Arm.



A17506D April 1929 - June 1930
Price Ea. \$ 16.50

8 1/4" Black, Multi Ply, Universal Use Blade with Cotter Pin Hole. Use A17565A Arm.



A17506E Price Ea. \$ 16.50

Show Electric (Flat) Tension Arm

This exact reproduction arm has been heat treated and cadmium plated. Includes the Special Square Head Tension Bolt, Knurled Nut and Cotter Pin. Not Stamped with Trico - 6 1/2" Cad.



A17565A 1928 - June 1929 Price Ea. \$ 21.95

Wiper Mounting Boots

These rubber boots slipped onto the mounting ears of the original electric wiper motors.



A17595AR 1928 Closed end
Price Ea. \$ 6.95

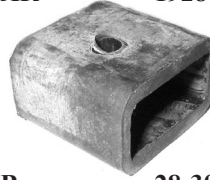

A17595B 28-30 Open End
Price Ea. \$ 2.85

Wiper Boot Plates

This plate goes on top of the wiper mounting boot on the later closed cars.

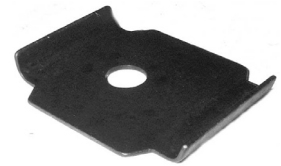

A17595P 29-30 Price Pair \$ 3.40

Wiper Motor Felt

This felt fits most motors in use today. It goes between wiper motor and the windshield frame on all closed cars. 3" x 5/8.

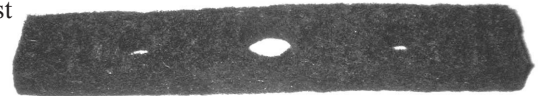

A17618 28-30 Price Ea. \$ 1.75

Manifold Hole Plug

This is the special slotted pipe plug which was used on the side of the block near the oil pump to let you see if your oil pump was working. This is also used for the valve fitting on the inlet manifold to plug the hole. To hold in the oil pump while changing the pan gaskets - use A6701 Page Gen. 118. This is also used to plug the intake manifold when an electric wiper is used.



A6621 28-31 Price Ea. \$ 0.65

Electric and Vacuum Tandem Wiper Kit

This kit allows you to add on a wiper for the passenger side so they can see, too! It will adapt to A17508 6V or 12 V Motor. Before drilling any holes, make sure the distance between the Motor Shaft and the Pivot Shaft is EQUAL to the length of the Link Rod Assembled to the Wiper Arm.



A17574 28-31 Price Set \$ 29.15

Mike's "A" FORD-ABLE Parts

There are not any decent New Vacuum Wiper Motors available. We can rebuild a good core.

Vacuum Wiper Motor Control

Here's the on/off control for the outside mounted wiper motor. This passes through the windshield frame.



A17534 28-31 Price Ea. \$ 3.95

Vacuum Wiper Mounting Screws

Here are the screws needed to mount the vacuum wiper motor.



A17500CMB 30-31 Closed car Price Pair. \$ 1.10

Show Quality Vacuum Arm

6 3/4" Black, Clip Type Arm used from June 1929 thru 1931 on Standard Coupes.



A17565B 29-31 Price Ea. \$ 16.00

Show Quality Vacuum Wiper Blade

8 1/4" Black, Single Rivet, Multi-Ply Blade with Clip for April 1929 thru 1931 Coupes.



A17506F 1929 - 1931 Price Ea. \$ 16.50

Wiper Blade

8 1/4" Black, Two Rivet, Multi-Ply Blade with Clip for 1931 Coupe.



A17506H 1931 Price Ea. \$ 16.50

Wiper Blade

8 1/4" Chrome, Two Rivet, Multi-Ply Blade with Clip for 1931 Deluxe Coupes.



A17506I 1931 Price Ea. \$ 16.50

Closed Car Blade Arm Support

These are the same design but the '28 model is shorter.



A17564A 1928 Nickel Plated Price Ea. \$ 26.00



A17564B 29-30 Nickel Plated Price Ea. \$ 26.00

Closed Car Manual Control Lever

This is a plated control lever.



A17575 28-30 Nickel Plated Price Ea. \$ 28.90

A17575B 28-30 Black Price Ea. \$ 27.50

Closed Car On-Off Lever

This is a plated on/off lever for the closed car.



A17580 28-30 Nickel Plated Price Ea. \$ 26.00

Trico Vacuum Wiper Bowl Gaskets

If you need only the bowl gaskets for your Trico motor, Mike's got them.



A17508G 29-31 Price Pair \$ 2.35

Trico Vacuum Wiper Motor Tag

If your Trico embossed tag has been painted or marred, replace it with this new one.



A17508T Price Ea. \$ 3.50

Chrome Vacuum Wiper Knob

Replace your worn knob with this new one.



A17513 28-31 Price Ea. \$ 1.75

Mike's "A" FORD-ABLE Parts

Trico Vaccum Wiper Knob

If you want the knob with "TRICO" on it, this chrome-plated knob is for you.



A17513D 29-31 Price Ea. \$ 3.50

Vacuum Wiper Hose

Six feet of the small diameter hose for the wiper. Rubber. Used on all cabs with wipers.



A17520 28-31 6 Ft. Price Ea. \$ 2.25

Fabric Vacuum Wiper Hose

For the show car, Mike has this simulated fabric covered wiper hose. Used on all cabs with wipers.



A17520OR 30-31 Price Ea. \$ 6.00

Vacuum Wiper Hose Header Clips

This set of three clips hold the wiper hose in place under the windshield hinge on the Coupe. The hinge screws also secure these clips. Sold as a set of three.



A17616 30-31 Price Set/3 \$ 2.95

Manifold Vacuum Line Connector

This is the brass connector that screws into the intake manifold that you connect the vacuum line to.



Manifold Hole size - 1/8 - 27 Pipe Thread.
A17540 29-31 Price Ea. \$ 1.10

Manifold Vacuum Line

Mike has the steel vacuum line with brass fittings included. This goes from the intake manifold up to the firewall.



A17543A 28-31 Price Ea. \$ 3.45

Manifold Vacuum Line Fittings

These are new quality vacuum line fittings. These are included with a new Manifold Vacuum Line A17543A or A17522.



A17543F 28-31 Price Ea. \$ 0.45

Firewall Vacuum Line Connector

This is the double female brass connector that attaches to the firewall for both inside and outside vacuum lines to connect.



Includes 1/2-20 Cad. Nut.
A17541 29-31 Price Ea. \$ 3.25

Inside Vacuum Line (Brass Fittings Included)

This is the steel vacuum line that goes from the firewall under the gas tank and up the stanchion on Coupes.

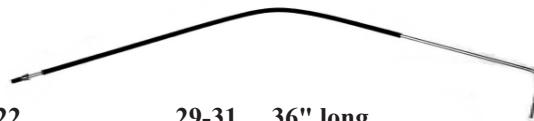

A17522 29-31 36" long Price Ea. \$ 4.10

COUPE

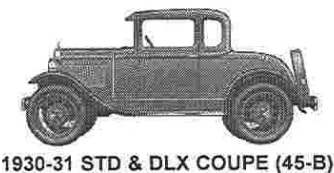

1930-31 STD & DLX COUPE (45-B)

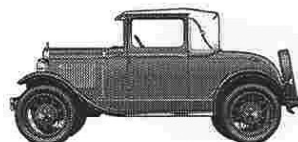

1930-31 SPORT COUPE (50-B)

Coupe Top Parts

Coupe Top Kits

These kits are complete with the top decking padding, and everything else you'll need excluding chicken wire. Instructions Included.

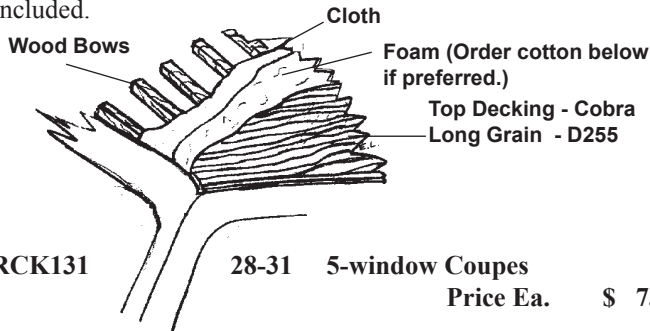

RCK131 28-31 5-window Coupes
Price Ea. \$ 73.95

Coupe Top Decking - Cobra Long Grain

Tops do wear out so Mike has this long-grain cobra top decking. It's 64" wide; the 5 Window Coupes need 5 ft. Sold by the foot.

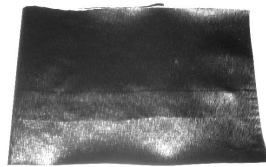

D255 28-31 Top Decking 64" wide
Price/Ft. \$ 6.95

Coupe Cotton Padding

This is the cotton padding that goes under the top decking. The padding is 40" wide.



A38200BR 28-31 Coupe Roll - 4 Foot
Price Ea. \$ 8.50

See Page Coupe 11 for Header Cover and Page Coupe 9 for Filler Trim

Coupe Prop Knobs

The Prop knob for the Sport Coupe has a different thread size with the polished stainless steel face.

1 3/4" Knob 3/8" - 24 Hex Nut.



A37708SP 29-31 Price Ea. \$ 8.45

Landau Brackets

These are aluminum brackets that go on the inside of the car. For Sport Coupe. Drilled and Tapped.



A51713/14 28-29 Price Pair \$ 68.25

Landau Brackets

Cast Bronze Lower Landau Stud Brackets. For the '30-'31 Sport Coupe.



A51713/14B 30-31 Price Pair \$ 60.50

Landau Spacers

These aren't wonderful. Cast aluminum must be drilled and finished. Includes 2 discs and the wedge-shaped pieces. Sport Coupe.



A52272/74A 28-31 Price Set/6 \$ 9.95

Landau Spacers

This is a good quality set of Bakelite spacers and 4 discs already covered with the top material. 6 Pieces.



A52272/74B 28-31 Sport Coupe Price Set/4 \$ 55.00

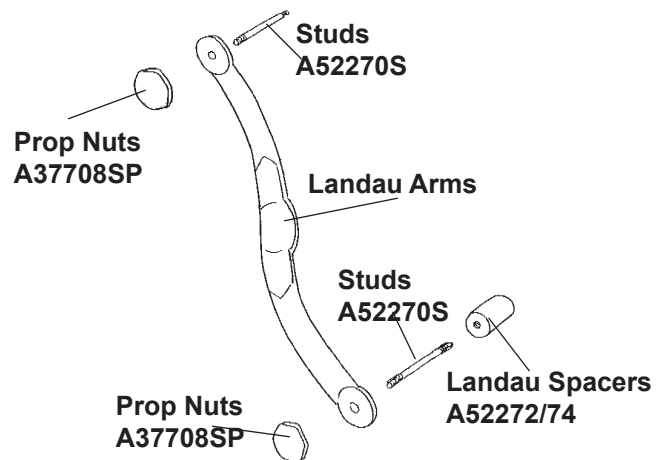

Landau Irons

These cast aluminum top irons will have to be drilled and finished; they fit the Sports Coupes for all years.



A52271X 28-31 Price Pair \$ 35.00

Landau Studs

This set has all four studs you'll need to mount the landau irons. 4 Studs & 2 Trim Acorn Nuts for the Sport Coupe.



A52270S 28-31 Price Set/4 \$ 12.25

Mike's "A" FORD-ABLE Parts

Rear Bow Sleeve Nut

An exact duplicate steel sleeve nut, not plated. Used on 28-31 Sport Coupes to fasten the rear bow to the rear bow support straps. See "How to Restore your Model A - Vol. 5" A91023.



A37809 28-31 Price Ea. \$ 14.00

***** Mike's Hints *****

Forming Rain Gutters - (A47301)

Trace gutter curve on the body to a piece of paper. Copy the curve to a 2" x 10" block of wood. Cut radius out of block with a jig saw. Nail a larger sheet of plywood to the 2" x 10" block. The "J" gutter is extra long, therefore place one hand at the end of the "J" molding and the other hand about 2 1/2 feet apart. You can waste the 6" - 8" where your hand is located. Slide the gutter across the plywood and pull it against the block to form the curve. The flat tacking strip should be cut half way across every 1/2 inch to be able to bend along the curve.

Coupe Rain Gutters

One set (90") will do both sides with this aluminum gutter that you bend to the contours of your car. Fasten the flat piece to the roof and the gutter piece snaps into it. Will work on any car with wood to nail it to. See hints for forming. Due to the length of gutters, they are shipped at OS2 70 Lbs rate and additional shipping will be charged.

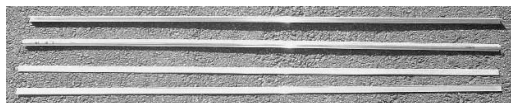

A47301A Coupes Price 1/2 Set \$ 12.00

***** Mike's Hints *****

Instructions on Aluminium Top Moulding

Nail the molding to the roof, then tap the edges in to hide the nails. A "V" shaped block of wood, will do the trick.

PLEASE NOTE: Top Moulding is shipped in a PVC Tube for protection. There is an additional UPS Handling Fee.

Coupe Front Top Roof Molding - Style # 1

This style of aluminum molding goes on the front over the sun visor for the '30-'31 Coupe 45B



A473011 5 Ft. Piece 5/8" wide Price Ea. \$ 12.60

Coupe Side and Rear Top Roof Molding Style # 3

This style of aluminum molding goes on the rear and sides of the '30-'31 Coupe 45B.



A473013 10 Ft. Piece 5/8" wide Price Ea. \$ 18.60

Coupe Top Roof Rear Molding - Style # 6

This is an aluminum molding which is nailed in the center and then rubber molding (A473019) is inserted into it to cover the nails. Used from 5/31 on the Coupes. Order 2 for Coupes.



A473016 30-31 Price Ea. \$ 19.50

Coupe Top Roof Molding - Rubber Insert Style # 9

This is the rubber insert for A473016. This is a 19 feet long, 3/16" wide, half round rubber molding.



A473019 30-31 Price Roll \$ 9.50

Coupe Top Roof Front Molding - Style # 8

This is the two-piece steel molding that goes over the sun visor '28-'29 Coupe 45A & '28-'29 Special Coupe 49A. Nail the tac strip down and snap the molding onto it.



A473018 28-31 6 feet long - need 2 pieces Price Set/2 \$ 18.45

Welting (Wire Welt) - Crown Vinyl Molding

This half round welt (wire welt) is often used in place of the metal roof molding. You nail it down and fold it over to form a nice fabric bead. Measure carefully as scraps cannot be returned. Comes per foot.



A47304 28-31 Price/Ft. \$ 0.90

Split Welting (Hid'em)

This split welting can be used with most models with a wood top.



A47305 28-31 Black Price/Ft. \$ 0.65
A47305T 28-31 Tan Price/Ft. \$ 0.80

Hid'em Welt End Tip

This nickel-finished tip (with nail) is used to complete the trim when using the hide'em welting (above).



A47303A 28-31 Price Ea. \$ 1.25

Front Gutter Clips

This style drip rail tip goes on the front drip rail moldings on the '28-'29 Coupes.



A47303D 28-29 Price Pair \$ 5.00

Rear Gutter Clips

This type of drip rail clip was used on the rear drip rail moldings on the '28-'29 Coupes and Special Coupes.



A47303E 28-29 Price Pair \$ 5.00

Front Gutter Clips

This nickel-plated drip rail tip goes on the front of the drip rail molding on the '28-'29 Sport & Business Coupes.

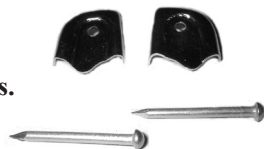

A53550/51 28-29 Front-Sport/Business Coupe
Price Pair \$ 5.00

Rear Gutter Clips

This nickel-plated tip goes on the rear of the drip rail moldings on the '28-'31 Sport and '28-'29 Business Coupes.

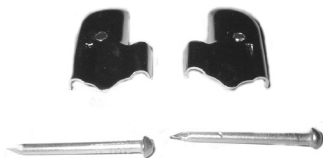

A52292/93 28-31 Price Pair \$ 5.00

Roof Tacks

This is a set of 100 zinc plated tacks used to tack the black vinyl decking to the wood top frame. The top molding covers these tacks.



A38425MBR 28-31 Price Pack \$ 2.25

Sport Coupe Side Roof Support Bracket

This brace fits from the quarter lock pillar to No. 2 roof bow. See Vol. 5 How to Restore - Page Gen. 79.



RAR261 28-31 Price Pair \$ 23.50

Sport Coupe Rear Bow Support

This brace fits roof bow No. 2 to beltrail - See How to Restore Volume 5 - Page Gen.79.



RAR262 28-31 Price Pair \$ 24.95

Body Nails

Commonly used on all Model "A's".



Nail Style #3

.074 diam. x 3/4" long - oval head - pack of 100

Price Pack \$ 1.50

Top Mouldings & Rain Gutters

Nail Style #4

.085 x 7/8" long - pack of 100

Price Pack \$ 1.50

Use these where rusting could occur - Stainless Steel

Nail Style #5

.085 x 3/4" long - pack of 100

Price Pack \$ 3.00

Window Shades & Brackets

Window Shade Brackets

These chrome brackets are used to mount your window shades.



A48301 28-31 Price Pair \$ 15.75

Coupe Rear Window Shades

Mike has shades available for the **Coupe**. Tan in color, they are ready to mount on your brackets.

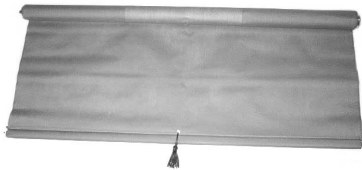

A4830024 Rear Window - 24" Price Ea. \$ 25.75



1928 - 1929 Sport Coupes

Coupe Door Handles & Parts

Locking Outside Door Handles

This chrome-plated locking handle was originally used only on the right-hand door but can be used on the left as well. Comes with 2 Keys.



A702350AL 28-29

Price Ea. \$ 34.00

A702350BL 30-31

Price Ea. \$ 34.00

Outside Door Handles

This chrome-plated handle was used only on the left hand door but it can be used on the right as well.



A702351A 28-29

Price Ea. \$ 27.50

A702351B 30-31

Price Ea. \$ 24.95

Door Handle Screws

This is a set of four machine screws to attach the door handle.
4 X 10/32 X 11/16 Oval Head Screws.



A702780MB 28-31

Price Set/4 \$ 1.25

Door Handle Pads

These flat rubber pads go between your outside handle and the car to prevent scratches and rattles.

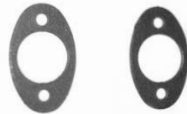

A702356B 28-29 Coupe

Price Pair \$ 0.85

A702356D 30-31 Coupe Price Pair \$ 1.00

A702356E 28-31 Rumble Price Ea. \$ 0.50

Door Handle Cup And Spring

You'll need one set per handle of this special cup washer and spring. The spring is crimped onto the outside door handles under the escutcheon. Not needed when purchasing new handles. Works best on original handles.
2 Piece Set - contains 1 spring & 1 cup.



A702350R 28-31

Price Set/2 \$ 1.55

Door Lock Cylinder

If you have a separate lock cylinder under a regular door handle, you will use this. Comes with 2 keys.



A702350L

28-31

Price Ea. \$ 12.40

Sliding Door Lock

This is the inside door lock that goes on the left hand door of the Coupes.



A46168

28-31

Price Ea. \$ 4.95

Sliding Door Lock Screws

This is a set of the small flat-head machine screws you'll need to attach the A46168 slide lock.



2 x 10/32 x 1/2"

A46168MB

28-31

Price Pair \$ 0.95

Coupe Lock Knob

This 10/32" threaded lock knob screws onto the stud of the slide door lock.



A46192A

28-31

Price Ea. \$ 2.95

Standard Slide Lock Escutcheon

This standard escutcheon for the slide lock is made just like the original.



Includes a large washer.

Used on:

1928 - May 1930 Coupes.

A46272AR

28-30

Price Ea. \$ 5.75

Deluxe Slide Lock Escutcheon

This is the escutcheon for the slide style inside lock on the left-hand door.

Includes a large washer.

After March 1930 - Coupe



A46272

28-31

Price Ea. \$ 3.45

Mike's "A" FORD-ABLE Parts

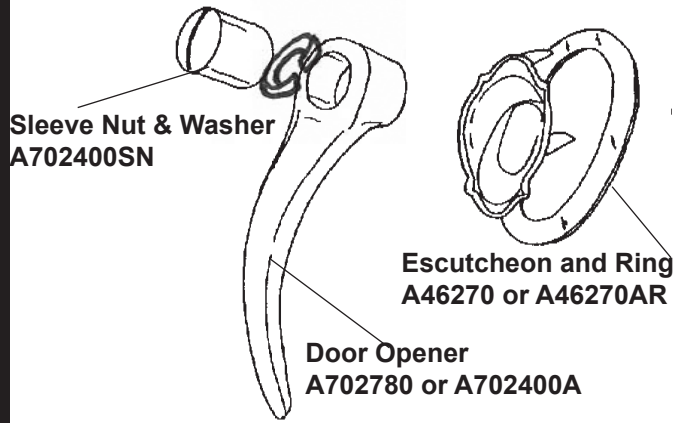

Coupe Inside Door Handles - Plain (Lift up Style)

This authentic reproduction was used on:
'28-'31 Coupes and Sports Coupes,
'28-'29 Special & Business Coupe
Order A46270AR Escutcheon.
Order A702400SN Sleeve Nuts



A702780AOR	28-31	Chrome	Price Ea.	\$ 6.95
A702780NOR	28-31	Nickel	Price Ea.	\$ 6.95

Coupe Inside Door Handle Escutcheon

This standard escutcheon for the inside door handles A702780AOR or NOR is made just like the original. Includes Washer. Used on:
1928 - May '30 Coupes.

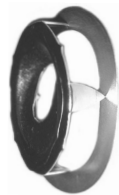

A46270AR	28-31		Price Ea.	\$ 6.75
----------	-------	--	-----------	---------

Coupe Door Handle Sleeve Nuts

These threaded sleeve nuts were used to hold the lift up style door handles on the shaft. 1 x 5/16 - 24 Nut & 1/w.



A702400SN	28-31		Price Ea.	\$ 1.45
-----------	-------	--	-----------	---------

Coupe Door & Window Riser Pins

A set of four pins, 1/8" diam. x 5/8" long, for the inside window Riser.



A46250P		Price Set/4	\$	0.65
---------	--	-------------	----	------

Coupe Inside Door Handle (Lift up Style)

This chrome-plated lift-up style inside door handle was used on:
'30-'31 Std & Deluxe Coupe
'30-'31 Sport Coupe
Order A702400SN Sleeve Nut.
Order A46270 Escutcheon.



A702400A	28-31	Square Top	Price Ea.	\$ 8.45
----------	-------	------------	-----------	---------

Coupe Deluxe Inside Door Handle Escutcheon

This is a deluxe style inside door handle escutcheon.
Includes washer. Used on:
March '30 - 31 Coupe.



A46270			Price Ea.	\$ 3.75
--------	--	--	-----------	---------

Standard Window Riser - A702780A

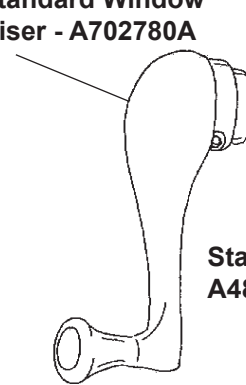

Standard Escutcheon
A48139AR

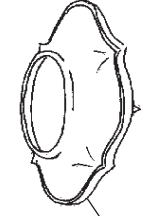

Deluxe Escutcheon
A48139B

Coupe Window Riser (Plain)

This is the standard chrome-plated window riser used on:
1928 - 1930 Coupes
Order A48139AR Escutcheon.



A702780A	May 28 - May 30	Price Ea.	\$ 8.75
----------	-----------------	-----------	---------

Coupe Standard Window Riser Escutcheon

Made in the USA. This is the standard escutcheon which fits between the window riser handle and the upholstery.
1-5/8" diam. x 5/8" high. Used on:
1928 - 1930 Coupe



A48139AR	28-30	Price Ea.	\$ 2.95
----------	-------	-----------	---------

Mike's "A" FORD-ABLE Parts

Deluxe Coupe Window Riser (Scroll Type)

The deluxe closed cars used this scroll window riser used on:

March 1930 - 31 Coupe

Order the **A46250P** to secure the handle.

Order **A48139B** Escutcheon.

A702780B

28-31

Price Ea. \$ 9.35



Coupe Spring Loaded Window Riser Escutcheon

A replacement style that can be used in place of the **A48139AR** or the **A48139B** Escutcheons.

Brushed chrome finish. I.S. is 11/16". Can be collapsed to a thickness of 15/32" or out as much as 5/8".

A48139RE

28-31

Price Ea. \$ 4.00



Deluxe Window Riser Escutcheon

This is a chrome plated deluxe style escutcheon which fits between the window riser handle and the upholstery.

Used on:

March '30 - 31 Coupe

A48139B

28-31

Price Ea. \$ 2.95



Escutcheon Spring

This cone-shaped spring fits behind the upholstery panel against the escutcheons to keep everything tight.

A48284

28-31

Price Ea. \$ 0.75



Quarter Window Handle

The '30-'31 Coupes with roll-down rear windows that go up and down used the "T" handle.

Includes a Pan Head Screw.

Order **A48139B** Escutcheon.

A164272BRC

30-31

Price Ea. \$ 10.00



Upholstery Clip

These clips are made to hold the upholstery to the door on the Coupes.

A46126

28-31

Price Set/10 \$ 2.50



Rubber Insert for Upper Door Seal

If you are only needing to replace the insert in your channel, this will do the job.

A19008R

28-31

Price Ea. \$ 2.80



Coupe Upper Door Seal

This is an aluminum channel with rubber insert that fits under the garnish moldings. The rubber rests against the window glass to maintain a seal as it goes up and down.



A19008A

28-29

Price Pair \$ 8.50

A19008B

30-31

Price Pair \$ 8.50

Coupe Interior Trim Screws

These sets of screws are exactly what is needed for the Coupe.

#1001

28-29

Coupe

Price Set

\$ 9.75

#1002

30-31

Coupe

Price Set

\$ 9.75

#1011

28-29

Sport Coupe

Price Set

\$ 9.75

#1012

30-31

Sport Coupe

Price Set

\$ 9.75

Coupe Robertson Interior Trim Screw Kits

For all Canadian built cars.



CR4

28-29 Standard & Special Coupe

Price Set

\$ 12.70

CR5

28-29 Sport & Business Coupe

Price Set

\$ 12.70

CR9

30-31 Coupe

Price Set

\$ 12.70

CR11

30-31 Sport Coupe

Price Set

\$ 12.70

Coupe Header Strips

Mike has these pairs of header strips which screw into the frame above the door.



A45890A

28-29

Price Pair

\$ 26.25

A45890B

30-31

Price Pair

\$ 26.00

Door Header Strip

These door header strips go between the front door post and the rear door post. They secure on the front with 2 flat head slotted machine screws & 1 rivet. The rear post top wooden header bolts to this with a metal trim piece under it.

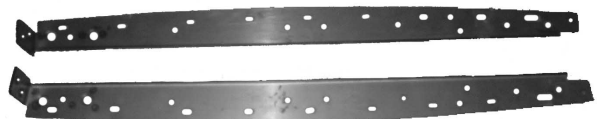

RAR269

30-31 Right

Price Each

\$ 24.95

RAR270

30-31 Left

Price Each

\$ 24.95

Mike's "A" FORD-ABLE Parts

Header Strip Screws

This set has enough screws to attach the pair of header strips on your Coupe. #8 1" Oval Wood Screw.



A45890MB 28-31 Price Set/12 \$ 1.25

Bottom Door Seal

This rubber seal goes on the bottom of the door and is held in place by the same clips that hold the door panel on. 1 Roll is enough for all Cars.



A19009 28-31 Price Roll \$ 6.25

Coupe Door Top Cover Plate

This stamped steel plate covers the top of the door where the side glass stops.



A45883A 28-29 Price Ea. \$ 39.95
A45883C 30-31 Price Ea. \$ 39.95

Coupe Door Top Cover Plate Screws

This 6 piece set of screws holds the top cover plate to the top of the door. 6 x 10/32 x 3/8 Flat Head Screws.

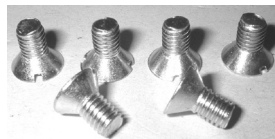

A45883MB 28-31 Price Set/6 \$ 1.10

Door Hinge To Door Screws

This set of nine screws is needed to attach the door hinge to the door. 9 x 5/16-24 x 1/2". some bodies require cup washers.



#109 28-31 Price Set/9 \$ 2.45

Door Hinge To Body Post Screws

This set of three screws is needed to attach the door hinge to the body. 6 Piece Set. 3 Screws and 3 Washers.



#109B 28-31 Price Set/6 \$ 1.75

Washers Only

A special countersunk washer used when mounting the floorboards. These washers are also used on some of the door hinges.



#109W 28-31 Price Ea. \$ 0.12

Hinge Pin Remover

This helpful tool, uses three graduating hardened push pins to push your old hinge pins up and out of the hinge. As you tighten the bolt it will push the dowel and the old pin out. Set comes complete with 3 different length push pins and complete instructions. NOT to be used on Slant Windshield Cars. This item is NOT Refundable!!

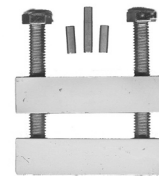

T46335HR 28-31 Price Ea. \$ 28.75

WARNING!!!

If your dowel pins start bending DO NOT go any further with this tool. These dowels are made from a hardened steel but NOT case hardened. The manufacturer has issued a warning that if a case hardened or heat treated steel was used, it could very well explode or splinter under such pressure, and possibly do bodily harm. I suggest trying penetrating oil, but if that doesn't work, then take a fine drill bit and try drilling at least halfway through the pin. Then use the removing tool.

Coupe Door Hinges

The hinge pin holes are drilled, but the body mounting holes are NOT drilled. Unfinished Cast Bronze. '30-'31 Shown.

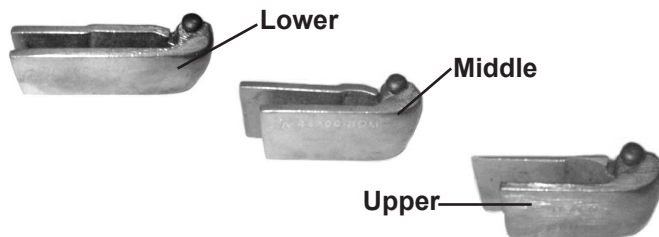

A46300AL	28-29	Lower Hinge	Price Ea.	\$ 78.00
A46300AM	28-29	Middle Hinge	Price Ea.	\$ 78.00
A46300AU	28-29	Upper Hinge	Price Ea.	\$ 78.00
A46300L	30-31	Lower Hinge 1 3/4" h x 4 1/4"	Price Ea.	\$ 78.00
A46300M	30-31	Middle Hinge 1 3/4" h x 3 3/8"	Price Ea.	\$ 78.00
A46300U	30-31	Upper Hinge 1 3/4" h x 2 3/8" w	Price Ea.	\$ 78.00

Mike's "A" FORD-ABLE Parts

Coupe Door Hinge Pins

These round headed hinge pins are authentic for the Coupes.



A46335	28-31	Standard - .233 / .236	
		Price Ea.	\$ 0.45
A46335OS	28-31	Oversized - .247 / .250	
		Price Ea.	\$ 0.45

Coupe Stainless Door Hinge Pin

This stainless steel hinge pin is knurled with a polished head.



A46335SS	28-31	Price Ea.	\$ 2.55
----------	-------	-----------	---------

Coupe Dovetail

This two-hole male dovetail was used on the Coupes. The female side for these will be in the Door bumpers kits below.

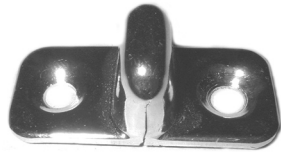

A76819A	28-31	Price Ea.	\$ 3.75
---------	-------	-----------	---------

Coupe Dovetail Screws

These machine screws hold the male dovetails in the door jams on the Coupes.



A76819MB	28-31	Price Set/4	\$ 1.25
----------	-------	-------------	---------

Door Bumpers

Mike has complete sets of the rubber, metal, and clips needed to change out the door bumpers for the following models. The rubber may need trimming. These are the best quality available.

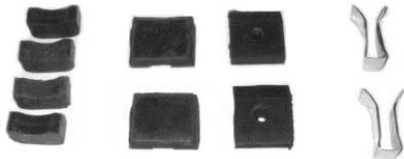

1928-1929 Coupe			
12 piece set.			
A702610AS	28-29	Price Set	\$ 11.25

1930-1931 Coupe			
A702610BS	30-31	Price Set	\$ 10.00

1928-1931 Sport Coupe			
10 piece set.			
A702610IS	28-31	Price Set	\$ 8.95

Coupe Door Bumper Clip

Spot Weld this three sided clip to the bottom of the door, 3 inches from the latch side, to hold the rubber door bumper in place. Uses one per door. 1928 - 1931 All Coupes



A46457	28-31	Price Ea.	\$ 4.25
--------	-------	-----------	---------

Door Bumper Dovetail Clip

This is the brass clip for the female dovetail on all and '28-'29 Coupes.



A702610C	28-29	Price Ea.	\$ 1.75
----------	-------	-----------	---------

Closed Car Door Latch

This excellent quality door latch fits the Coupes. The driver's side latch has the lock mechanism.



A46105AR	28-29	Passenger side	Price Ea.	\$ 21.00
A46106AL	28-29	Driver's side	Price Ea.	\$ 21.00
A46105BR	30-31	Passenger side	Price Ea.	\$ 21.00
A46106BL	30-31	Driver's side	Price Ea.	\$ 21.00

Latch Wood - Door Lock Cover

This is the latch wood that is mounted vertically about halfway up the door post. Originally this was made of hard rubber.



AWD1288-3	30-31	All Coupes	
AWD1287-8	28-29	Standard Coupe	
AWD1286-12	28-29	Special Coupe	
AWD1284-5	28-29	Sport Coupe	
		Price Pair	\$ 15.40

Closed Car Latch Screws

This set has enough screws to attach the door latches on both sides on the Coupes.



A46105MB	28-31	Price Set/8	\$ 1.10
----------	-------	-------------	---------

Mike's "A" FORD-ABLE Parts

Closed Car Latch Rivet

This special tubed rivet holds the flipper to the latch mechanism.



A46105RI 28-31

Price Ea. \$ 0.55

Closed Car Door Latch Spring Set

This set has all the springs needed for both door latches for all 1928-1931 Coupes.



A46125 28-31

Price Set/7 \$ 6.60

Closed Car Striker Plate

This type of striker plate was used on Coupes.



A46137 28-31

Price Ea. \$ 3.45

Striker Plate Mount Kit

There are enough screws here to attach the A46137 strikers on one door.
1/4-20 x 1/2 Round Head Screws.



A46137MB 28-31

Price Set/4 \$ 0.75

Bezel

This bezel clamps onto the door panel where the panel is notched for the striker.



A48140 28-31

Price Pair \$ 2.50

Kick Panel Retaining Clip

These clips hold the bottom of the kick panel snug.

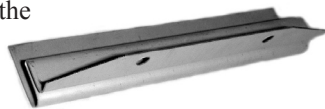

A40555CL 28-31

Price Pair \$ 5.75

Inside Door Latch Remote Rods

This is the rod that links the inside door handle to the door latch. Originals are almost always worn out or the threads are stripped. One kit does both doors. Kit includes the retainer plates, return spring and mounting screws.



A702401A	28-29	Coupe	Price Set/12	\$ 33.00
A702401B	30-31	Coupe	Price Set/12	\$ 33.00

Inside Door Opener Control Rod Mounting Plates

These are the plates that hold the inside door handle remote rods in place. The set includes 4 plates and 4 mounting screws.



A702403S	28-31	Coupe	Price Set/8	\$ 11.55
----------	-------	-------	-------------	----------

Door Check Post Bumper

This pair will do both doors. The square rubber mounts in the door post for the door check bumper to butt against.



A702828BU	28-31		Price Pair	\$ 3.95
-----------	-------	--	------------	---------

Door Check Arm Brackets

Top and bottom brackets are spot welded to the door post to receive the arm (A702828CL). Order 1 set per door.

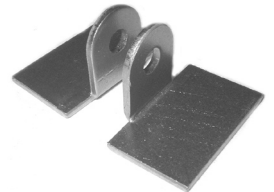

A702828BRKT	28-31		Price Set/2	\$ 4.90
-------------	-------	--	-------------	---------

Door Check Arm And Rubber Bumper

This steel arm door check was used on all the Model A's that didn't have the rubber strap style footman's loop.



A702828CL	29-31	Front door on closed cars	Price Pair	\$ 6.15
-----------	-------	---------------------------	------------	---------

Door Check Bumper

This style of rubber bumper was used with the steel arm door checks. It attached inside the door.



A702828R	29-31		Price Pair	\$ 2.05
----------	-------	--	------------	---------

Mike's "A" FORD-ABLE Parts

Closed Car Check Straps

This double loop door check strap is 6" long and was used on



'28-'29 Coupes with side mount spare tires..

A162592-6 Price Ea. \$ 3.65

This double loop door check strap is 8" long and was used on the '28-'29 Coupes without sidemount spare tires.

A162592-8 Price Ea. \$ 4.00

Door Check Strap Bracket Screws

1928 - 29 Closed Cars Only. This is the set of screws needed to attach your door check strap. 12/24 x 3/4" Oval Head Machine Screw.



#48 28-29 Set of 8

Price Set/8 \$ 1.50

Windlace Rivets

This kit of tube-style rivets holds the windlace retainer in place on the '28-'29s. Use these to attach A45983CL to A45983. For window channel.



A46127 28-29 Price Set/20 \$ 2.40

Windlace Retainer

The '28-'29's used this steel strip to hold the windlace on the front of the door opening



A46128 28-29 Price Ea. \$ 18.25

Window Regulator

This good quality window regulator is the three-hole type used on the Coupes.

Top quality! A48105A is also used on Deluxe Coupe Roll down windows.



A48105A 28-31 Passenger Side Price Ea. \$ 36.95

A48106A 28-31 Driver's side Price Ea. \$ 36.95

Window Regulator Bolts

This set of countersunk screws with star washers will attach the window regulators on both doors of the Coupes.

3 x 1/4 -20 x 5/8.



A48105MB 28-31 Price Set/6 \$ 1.50

Window Regulator Spring

Mike also has this separate main spring of the window regulator in case that's all you need.



A48405/6 28-31 Price Ea. \$ 5.80

1928 - 1931 Position of Window Felt Channels and Regulators

Top Window Cushion - Page Coupe 44 - A45985

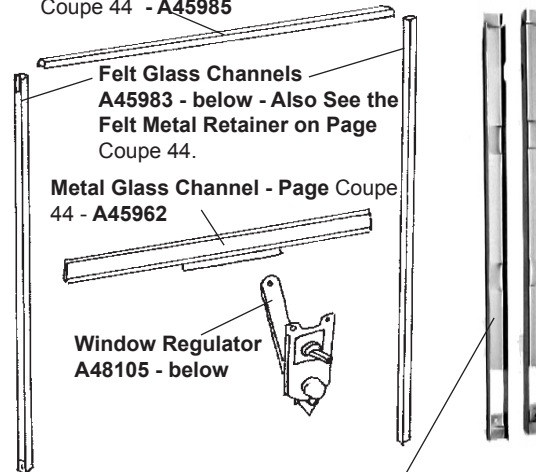

Felt Glass Channels A45983 - below - Also See the Felt Metal Retainer on Page Coupe 44.

Metal Glass Channel - Page Coupe 44 - A45962

Window Regulator A48105 - below

Metal Retainer - Page Coupe 44.

For Glass See Page Coupe 28.

Economy Window Channel Kit

Unassembled kit for you to put together yourself. One kit does one door ONLY. Kit contains: 2 - 32" felt channels, 1 - upper sponge rubber, 2 - upper clips, 2 - lower clips and 8 - rivets.



A45983S 28-31 Price Kit \$ 16.50

Front Door Window Channel Kits

These kits include all of the necessary moulded channels with clips attached, upper window sponge seals, "T" shaped anti-rattle rubber (when required), lower glass cushion bumpers and adhesive.



One kit does both front doors.

A45983A 28-29 Coupe and Sport Coupe Price Kit \$ 49.50

A45983B 30-31 Coupe and Sport Coupe Price Kit \$ 49.50

Mike's "A" FORD-ABLE Parts

Coupe Back Roll-Down Window Channel Kit

This kit services cars that have a back window that rolls up & down.



A46108 30-31 3 and 5 Window Coupes
 Price Kit \$ 22.00

Felt Glass Channel Clip

This clip goes at the bottom of each felt glass-channel to hold them in place.
 2 Clips.

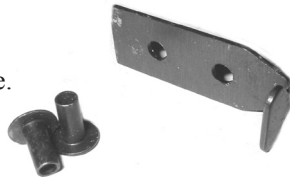

A45983CL Price Pair \$ 1.50

Top Window Cushion

Attach this 30" strip of sponge rubber to the top of the window track with any good auto trim adhesive.

Forms a good cushion and seal.



A45985 28-31 Price Ea. \$ 2.25

Glass Bumper

This rubber bumper mounts on the ledge inside the door for the side window glass channel to rest on.

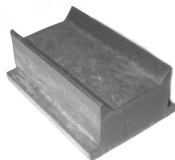

A48141 28-31 Price Ea. \$ 0.90

Door Window Felt Metal Retainer

Spot Weld this metal "U" channel to the edge of the door to hold the glass felt in place. One tubular rivet is included to attach the bottom. 16 1/2" Long.



1930 - 1931 Coupe and Sport Coupe

A45986A	30-31	Lock Side - Right Door	Price Ea.	\$ 10.25
A45987A	30-31	Lock Side - Left Door	Price Ea.	\$ 10.25
A45996	30-31	Hinge Side - Right Side	Price Ea.	\$ 10.25
A45997A	30-31	Hinge Side - Left Side	Price Ea.	\$ 10.25

1928 - 1929 Coupe, Sport Coupe, Special Coupe, Business Coupe

A45980	28-29	Hinge Side - Right Door	Lock Side - Left Door	Price Ea.	\$ 10.25
A45981	28-29	Hinge Side - Left Door	Lock Side - Right Door	Price Ea.	\$ 10.25

Metal Glass Channel

This metal channel holds the bottom of the door glass and the window regulator fits into the slot on the bottom. Good for both sides, this fits all Coupes.



A45962 28-31 Price Ea. \$ 9.35

Glass Setting Rubber

Made in the USA. This U-shaped rubber is used to mount the rear and quarter windows in the frame.

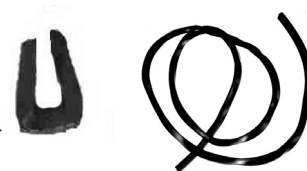

For Glass See Page Coupe 28.

A19003C	Quarter and rear windows	Price Set	\$ 10.25
A19003R	Rear window only	Price Ea.	\$ 4.95

Mike's "A" FORD-ABLE Parts

Roll Down Rear Window Kit

This kit has all the hardware you'll need to convert your stationary rear window to a roll-down window.

A91200	30-31 Coupe - Excluding Glass	Price Ea.	\$ 339.25
A94805	Glass Only	Price Ea.	\$ 39.60
A91201	Steel Window Frame	Price Ea.	\$ 86.50
A91202	Wood Window Frame	Price Ea.	\$ 97.00
A91203	Drip Pan	Price Ea.	\$ 57.75
A91204	2 Metal Brackets	Price Pair	\$ 9.00
A164272BRC	Quarter Window Handle	Price Ea.	\$ 10.00
A48139B	Deluxe Escutcheon	Price Ea.	\$ 2.95
A48284	Escutcheon Spring	Price Ea.	\$ 0.75
A48105A	Window Regulator	Price Ea.	\$ 36.95
A45962	Metal Glass Channel	Price Ea.	\$ 9.35
A46108	Felt Glass Channel	Price Set	\$ 22.00
A91205	Complete Bolt Set	Price Set	\$ 5.00
A91206	Instructions	Price Ea.	\$ 2.00

Insulation

Firewall & Complete Car Insulation

If you tour in the heat of the summer (and who doesn't?), you'll want one of these insulators to keep engine heat out. It mounts inside the firewall and is molded to look like the firewall.

A18572A
Shown

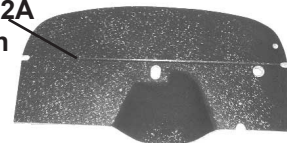

A18572A	28-29	Price Ea.	\$ 120.00
A18572B	1930 - 1931	Price Ea.	\$ 120.00
A18572C	1931 - Indented	Price Ea.	\$ 120.00

Complete Car Insulation

A multi-stage, automotive sound damping and insulation system for your Model A. Reduce engine and road noise, vibration and heat. This is the stuff that Henry Ford left out of original production and it makes all the difference in driving comfort! Should be able to install in approx. 2 hours. Complete instructions included. These are shipped directly from the manufacturer to you.

1928 - 1929 Standard, Business, Sport & Special Coupe

A18800K	Complete Kit	Price Set	\$ 329.00
A18800A	Floor Kit	Price Set	\$ 89.00
A18800B	Trunk Kit	Price Set	\$ 49.00
A18800C	Body Panel Kit	Price Set	\$ 59.00
A18800E	Cowl Kit	Price Set	\$ 29.00
A18800F	Roof Kit	Price Set	\$ 89.00
A18801	Door Damper Kit	Price Set	\$ 29.00

1930 - 1931 Standard, Business, Sport & Special Coupe

A18835	Complete Kit	Price Set	\$ 329.00
A18835A	Floor Kit	Price Set	\$ 89.00
A18835B	Trunk Kit	Price Set	\$ 49.00
A18835C	Body Panel Kit	Price Set	\$ 59.00
A18835D	Cowl Kit	Price Set	\$ 29.00
A18835E	Roof Kit	Price Set	\$ 89.00
A18801	Door Damper Kit	Price Set	\$ 29.00

Gas Tank

Specifications:

Steel thickness: .049" to .051" (terne plated)
Capacity: 28-29, 10 gal.; 30-31, 11 gal.

The following new parts are required to complete a restoration of your Gas Tank. This is only a guide - do not assume that this is all that is needed, all other parts need to be thoroughly checked.

1. Gas Tank Sealer - AGTS
2. Fuel Tank Welt Anti-Squeak - A9006
3. Gas Tank Filler Screen - A9020
4. Fuel Shut Off - A9189A or B
5. Fuel Shut Off Filter - A9193T or A9194B
6. Filter in Gas Bowl - A9156
7. Gas Lines - A9230A, B, A9230AV, BV, A9240B, C
8. Gas Gauge Tool - T9300
9. Gas Gauge Rebuilding Kit - A9320S
10. Gas Gauge Nut - A9326 - Inner - A9330 - Outer
11. Intake and Exhaust Manifold Gaskets - A9433F, A9433, A9433C, A9433C2
12. Carb Kit - A9595Z, B or T
13. Grose Jet - A9564GJZ, GJT or B9564Z
14. Choke Rod Assembly - A9700B or C
15. Grommet Set - A9066A or A9715/17
16. Control Rods - A9740S
17. Sediment Bowl - A9155
18. Sediment Bowl Gaskets - A9173 or N

Gas Tank Sealer

Extend the life of your old tank with this semi-elastic sealant. Seals pin holes, covers rust flakes, not affected by alcohol. Cannot be shipped by air. For best results, have the gas tank chemically cleaned and rust free before using this sealer.



AGTS 28-31 Price Quart \$ 25.00

Gas Tank Etching

Remove light rust inside of your gas tank before you put in the AGTS Gas Tank Sealer. This will leave a gray phosphate coating. 16 Oz.



A9002E 28-31 Price Each \$ 11.75

Cowl Welt

This roll of 1/8" black beading is used when you mount your gas tank.

'28-'29 Across back edge of tank and down sides of cowl.

'30-'31 Around back edge and sides.

Paint lower body color.

A3405CW 28-31 10 Ft. Roll Price Roll \$ 3.75



Gas Tank Anti-Squeak Welt

This 1/16" x 12 ft. woven fabric welt is used as a buffer around the gas tank to eliminate rattles. The early models use it all the way around the tank; the later models on the front and back edges.



A9006 28-31 Price Roll \$ 3.60

Gas Tank Filler Screen

This tab-style screen sits in the neck of the gas tank. Does not fit early threaded style. See page 441 of Service Bulletins for correct installation.

These will **not** work with tool - T9021 - below.

A9020 28-31 Price Ea. \$ 10.45



Gas Tank Filler Screen Tool

A great tool to help with the installation or removal of the Filler Screen (A9020). Place the tool in the filler neck notches and use a socket wrench and extension.

For original Screens Only.

T9021 28-31 Price Ea. \$ 3.75

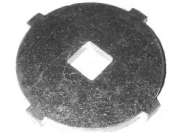

Gas Tank Protector

Lay this lined naugahyde on top of the tank when filling to protect your finish.



A9030P 28-31 Price Ea. \$ 21.95

Gas Tank Speedo Cable Grommet

This elongated grommet will help save your cable that runs under the gas tank in the tunnel to the speedo.



A9066R 28-29 Price Ea. \$ 3.45

Firewall to Gas Tank Screws

This set of screws has all the parts needed to attach the gas tank to the firewall.

Paint lower body color.

10 12-24 x 19/32 Pan Head Screw & Lockwasher.



#46 30-31 Price Set \$ 2.95

COUPE

Mike's "A" FORD-ABLE Parts

Firewall to Gas Tank Bolts

This set of bolts is what you'll need to attach the gas tank to the firewall.
8 x 3/8 Tall Headed 1/4 - 20 5/8" Bolts, Lockwashers & 1/2" Nuts.
 Paint lower body color.



#46A 28-29 Price Set/8 \$ 4.10

Gas Tank To Belt Rail Bolts

This set of bolts is what you'll need to attach the gas tank to the cowl. Bolts secure the back edge of the tank to the dash rail support.



#46B 28-29 1/4-20 x 1/2" Bolts, LW's & Hex Nuts
 Price Set/24 \$ 3.85



#46C Early 1930 12 x 1/4" - 20 3/4" Bolts & L.w.
 Price Set/36 \$ 3.85



#46D Mid 1930 Size changed to 5/16-24 x 25/32" Bolts, LW's and Nuts.
 Price Set/36 \$ 3.85



#46E Late 1930 to End -
 The same 5/16-24 x 25/32" Bolts were used, except the nuts were placed inside a cage. Unfortunately these cage nuts are no longer available.
 Price Set/24 \$ 4.85

Gas Cap

Vented gas cap in the style used for '28-'29 cars. Chrome over brass. Includes gasket.



A9030A 28-29 Price Ea. \$ 17.90

Show Quality Gas Cap

Vented stainless steel gas cap for '30-'31. This is the best quality available. It's a copy of the original Eaton style cap. These really fit. Includes the correct gasket.



A9030C 30-31 Price Ea. \$ 19.95

Gas Cap Gaskets

Treated leather gaskets.



A9035A 28-29 Price Ea. \$ 0.65



A9035 30-31 Price Ea. \$ 0.95

Sediment Bowl Repair Kit

Rebuild kit to improve the functioning of original cast iron sediment bulb on the firewall. Instructions included.



A9155RK 28-31 Price Kit/3 \$ 4.75

Glass Sediment Bowl Micro Filter

Improve the efficiency with this filter which fits inside the glass bowl. Instructions included. Can only be used with A9155 - See Page Coupe 48.



A9156 28-31 Price Set/3 \$ 4.50

Sediment Bowl Screen

This brass screen fits between the bowl gasket and the bulb housing on the glass sediment bulbs

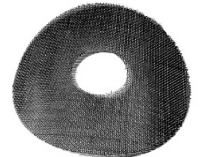

A9155SC 28-31 Price Ea. \$ 1.65

Mike's "A" FORD-ABLE Parts

Sediment Bowl Assembly

Glass sediment bowl was originally an option from **Mid '29** but will work on all 's, except for indented firewalls. Gasket (A9173 - below) and Screen (A9155SC - Page Coupe 47) are included. Use Micro Filter (A9156 - Page Coupe 47) in this Bowl.



A9155 28-31 Price Ea. \$ 26.95

Late '31 Filter Kit

Use this kit if you are NOT running the correct side-bowl style Zenith Carb. Designed to accommodate the late 1931 Model A's with the gas valve on the firewall. Includes a glass bowl type sediment bulb along with gas lines and fittings to install. The copper sediment bowl screen can be replaced by using A9155SC.

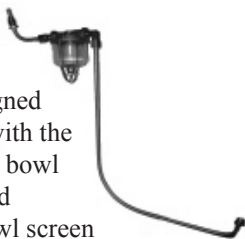

A9155L 1931 Price Kit \$ 27.95

Sediment Bowl Gaskets

For the glass sediment bowl. Neoprene should be replaced when you remove the bowl.



A9173 28-31 Cork Price Ea. \$ 0.35



A9173N 28-31 Neoprene Price Ea. \$ 0.55

Sediment Bowl Glass

Replace your discolored bowl with a new clear one.



A9158 28-31 Price Ea. \$ 5.50

Side Bowl Filter

On the late '31 A's, Ford moved the filter to the side of the carburetor. Complete with all hardware.



A9161 1931 Price Set \$ 51.00

Side Bowl Filter Without Hardware

If all you need is the side bowl filter, and not all of the hardware.



A9161A 1931 Price Ea. \$ 33.00

1928 to 1931 Cast Iron Sediment Bowl

7/8 - 14 Nut
(1-1/4 Wrench)
A9156A

Lock Washer

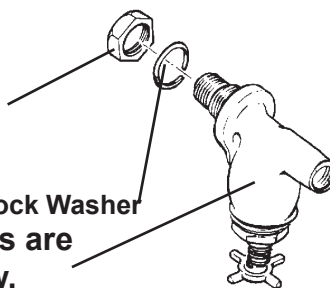

These three items are not available new.

Mid 1929 to Early 1931 Glass Sediment Bowl

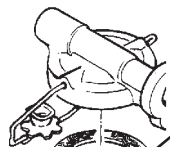

Cork / Neoprene Gasket - A9173 & N



Screen -
A9155SC



Glass Bowl -
A9158

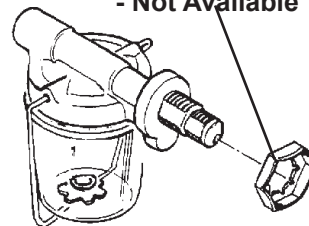

Special Nut
(No Lock Washer)
- Not Available

Thanks to Les Andrews for the use of his drawings.

Side-Bowl Rebuild Kit

With this you can rebuild your side bowl filter. Mounted on the side of the carb.



A9161SC Late 1931 Price Kit/3 \$ 2.25

Side Filter Bolt

This is the special bolt to hold the side bowl filter to the carb on the late '31 A's.



A9161B 1931 Price Ea. \$ 4.60

Side Bowl Drain Valve and Spring

For the late '31 A's, this drain needle with spring screws into the bottom of the filter.

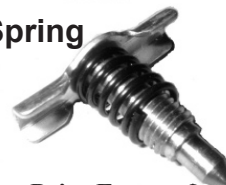

A9161V 1931 Price Ea. \$ 6.35

Sediment Bowl Brass Cap Plug

For Cast Iron bulbs. Goes into the bottom of the cast iron sediment bulb and A9177 (Page Coupe 49) threads into it.



A9175 28-31 Price Ea. \$ 8.50

COUPE

Mike's "A" FORD-ABLE Parts

Sediment Bowl Brass Drain Valve & Forged Drain & Spring.

For Cast Iron bowls.



A9177 28-31 Price Set \$ 11.95

Installation of Repair Kit for Cast Iron Bowl

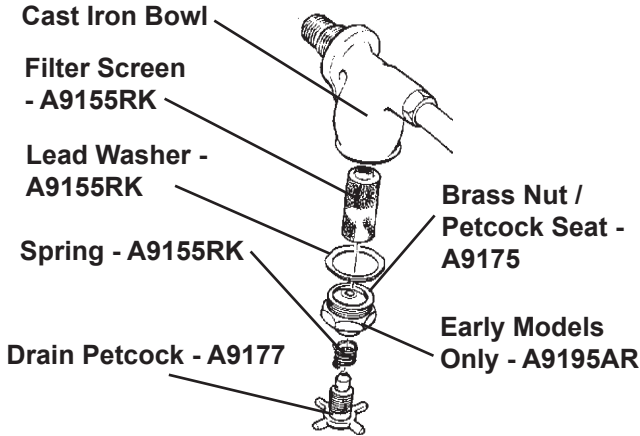

Fuel Shut off Valve

This all brass valve is inside the car to shut the gas off going to the carb.



A9189A 28-31 Price Ea. \$ 32.25



Installation of Fuel Shut Off & Gas Tank Screen (A9193T) into A9189A

Gas Tank Screen (Fuel Shut Off)

This screen presses into the gas shut-off valve where it goes into the gas tank to keep sediment and rust out of the carb.



A9193T 28-31 Price Ea. \$ 3.15

Fuel shut Off Valve Packing Nut

This brass nut holds the packing in place the sediment bulb.

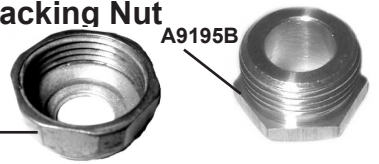

A9195AR 1928 - late 1929 Price Ea. \$ 3.50
A9195B 1929-1931 Price Ea. \$ 2.50

Late '31 Gas Shut Off Valve

This all brass valve was used on the late '31 A's with the indented firewall. This is fitted onto the firewall in the engine compartment.



A9189B 1931 Price Ea. \$ 36.95

Electric Fuel Cut Off Don't Leave this off!!!!

How often have we forgotten to switch off the gas. Well now you don't have to, just leave your gas on and let the Electric Fuel Cut Off do the job for you. Made to go on your 1/4" fuel line that runs from the firewall to the carburetor. Simply Turn the key On or off - THAT'S IT. Comes with Complete instructions. Available in 6 or 12 Volt.



A9189 28-31 6 Volt Price Set \$ 55.00
A9189/12V 28-31 12 Volt Price Set \$ 55.00

Fuel Valve Grommet

For the late '31 valves that mount on the firewall, you'll need this excellent repro. to go in the hole.



A9171 1931 Price Ea. \$ 1.95

Gas Shut Off Fuel Valve Handle Only

Handle only for the earlier (A9189A) shut off valve.



A9189H 28-31 Price Ea. \$ 2.95

Gas Shut Off Fuel Valve Handle Only

This is the forged style handle used from the beginning until April 1929.



A9191A 28 - April 29 Price Ea. \$ 13.95

Gas Shut off Valve Packing

If your shut off valve isn't shutting off, try replacing the packing before buying a new valve.



A9193 28-31 Price Ea. \$ 0.95

Mike's "A" FORD-ABLE Parts

Gas Valve Repair Kit

Use this complete kit to rebuild the original style gas valve. Includes packing, jam nut, lock washer and gas resistant lubricant. Will also fit late '31's.



A9193S 28-31 Price Set/4 \$ 2.50

Inside Gas Lines

This line connects the gas valve under the gas tank to the sediment bowl on the firewall. 5/16" tubing.



A9230A 28-29 Price Ea. \$ 7.50

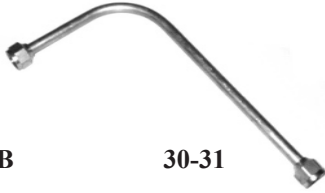

A9230B 30-31 Price Ea. \$ 6.75

Modern Gas Line Valve

If you are having continuous trouble with your gas line valve - we now have a modern valve in line - this guarantees a complete shut off with a quarter turn of the handle. Leave your A9189A or B in place then attach the A9230AV or BV.

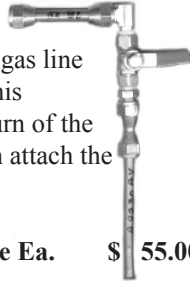

A9230AV 28-29 Price Ea. \$ 55.00

This is an excellent solution to a leaking gas problem.

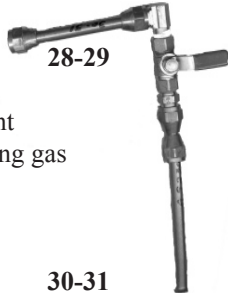

A9230BV 30-31 Price Ea. \$ 55.00

Gas Line

This line with brass fittings connect the sediment bulb to the carb. Not for the late '31's A's.

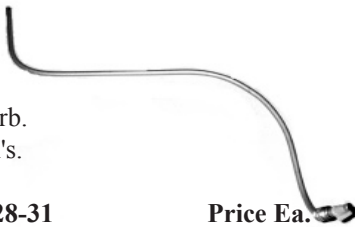

A9240B 28-31 Price Ea. \$ 4.50

For the late '31's with indented firewalls and side bowl carburetors. Includes Fittings.



A9240C 1931 Price Ea. \$ 4.60

Gas Line Fitting

Like the original brass gas line fittings.



A9243 28-31 Price Ea. \$ 1.50

Gas Line Fittings

Like the original 9/16 head fittings used on the late '31 A's. Set ferrule no more than 1/8" from the end of the tube.

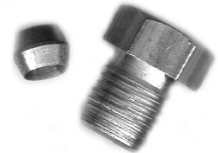

A9243B 1931 Price Set \$ 2.80

Gas Tank Clamps

Hold the bottom of the gas tank stable with these. 5 per side needed for '28-'29; 2 per side needed for '30-'31.



A35266AR 28-29 10 Needed Price Ea. \$ 2.40



A35266BR 30-31 4 Needed Price Ea. \$ 2.40

Order Online Now and Save 5%

Visit our website for all your Model "A" needs.



www.mikes-afordable.com

COUPE

Gas Gauge

Tool Set

Safely work on your gas gauge with this cast aluminum heat treated tool set. Will not damage nuts.



T9300 28-31 Price Set/2 \$ 6.45

Gas Gauge Assembly

Complete assembly
Inner and Outer Nut &
Gaskets.

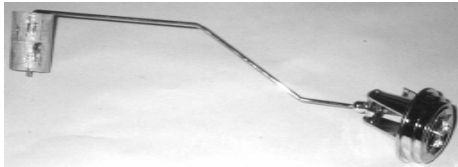

A9312D 28-31 Price Set \$ 36.30

Gas Gauge Assembly

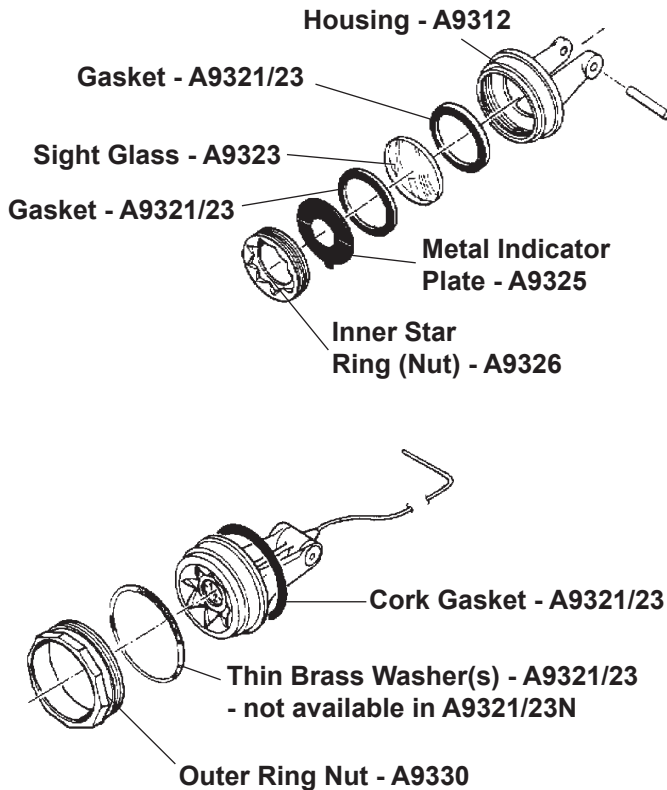

Thanks to Les Andrews for the use of his drawings.

Gas Gauge Rebuilding Set

This set includes cork gaskets, lens, face plate and cork float. The order is gasket, glass, gasket, face plate, inner nut.

Large gasket against tank, gas gauge assembly, brass washer & outer nut.



A9320S 28-31 Price Set/9 \$ 5.95

Gas Gauge Cork Float Only

You can buy this cork float separately if its all you need.

Treated to resist gas.



A9312F 28-31 Price Ea. \$ 1.95

Gas Gauge Neoprene Float

You can now get a Gas and Alcohol proof float to eliminate the problem of having your cork float disintegrate over time in the gas.



A9313B 28-31 Price Ea. \$ 4.45

Gas Gauge Brass Float

Modern style gas float based on the design of a carburetor float. You should never have any trouble with this.

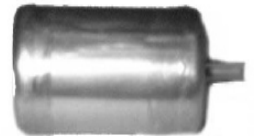

A9313C 28-31 Price Ea. \$ 9.95

Gas Gauge Gaskets

Choose between cork like Ford used or modern neoprene.

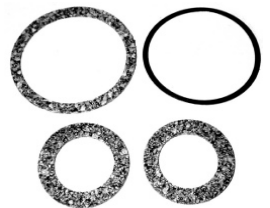

A9321-23 28-31 Cork Price Set/4 \$ 1.25

A9321-23N 28-31 Neoprene Price Set/4 \$ 1.75

Gas Gauge Lens

Glass lens.

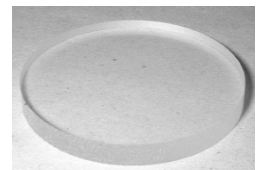

A9323 28-31 Price Ea. \$ 0.95

Gas Gauge Face Plate

Like the original.

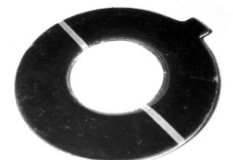

A9325 28-31 Price Ea. \$ 2.10

Mike's "A" FORD-ABLE Parts

Gas Gauge Inner Nut

Chrome Finished inner nut for the "A" gas gauge.



A9326 28-31

Price Ea. \$ 6.55

Gas Gauge Outer Nut

Chrome finished outer nut for the "A" gas gauge.



A9330 28-31

Price Ea. \$ 6.75

"B" Fuel Pump Rebuild Kit

A complete rebuild kit for your '32-'34 4 cyl. fuel pump.

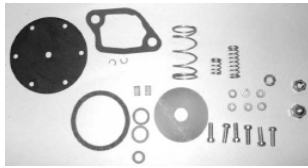

B9349A 32-34

Price Set \$ 39.95

"B" Fuel Pump Gasket

This gasket goes between the block and the fuel pump on a "B" 4 cyl. engine.

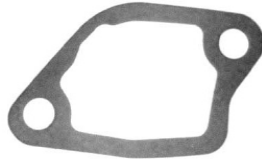

B9374 32-34

Price Ea. \$ 1.00

"B" Fuel Pump Diaphragm

Included in the B9349A kit.

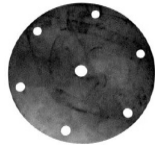

B9390 32-34

Price Ea. \$ 5.00



1931 Deluxe Coupe owned by Mr. J. Donaldson.

COUPE

Speedometer

Speedometer Mount Set

This set of 2 screws, nuts, and lock washers is used to mount your speedometer to the instrument panel.



A17255MB 28-31 2 x 1/4" - 20 x 1/2" screws + 1/2" square nut & lock washer
Price Set/4 \$ 0.80

Rebuilt Speedometers

Sold on **EXCHANGE ONLY**. Mike must have your complete re-buildable core to ship a rebuilt one out.

NO OUTRIGHT SALES.

NO EXCEPTIONS.

Only Stewart Warner Speedometers are still being rebuilt.



A17255AS 28-30 Oval face
Price Ea. \$ 225.95

A17255BS 30-31 Round face
Price Ea. \$ 225.95

Speedometer Bezel Rim - Nickel

Shiny new face plate to replace that cracked or broken plate.



A17259A 28-30 Oval S/W
Price Ea. \$ 19.95

A17259C June '30-31 Round S/W
Price Ea. \$ 16.75

A17259D June '30-31 Round Waltham
Price Ea. \$ 16.95

Speedometer Lens

If your old glass lens has gotten scratched or dingy over the years, replace it with one of these.

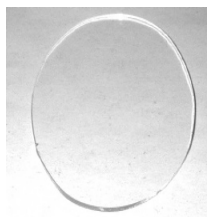

A17256AR Oval Price Ea. \$ 1.10

A17256B Round Price Ea. \$ 1.00

Speedometer Lens Gaskets

Mike also has new gaskets for the speedometer lens.

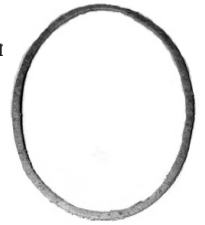

A17257AR 1928 - June '30 Oval face
Price Pair \$ 1.15

A17257B July '30 - 1931 Round face
Price Pair \$ 1.15

Speedometer Lens Retainer

This ring holds the lens into the chrome face for the round speedometer.

Sorry not available for Oval Lenses.



A17258B 30-31 Price Ea. \$ 3.25

Speedometer Face Plate

This is the black plate that fits behind the chrome facing on the Speedometer.

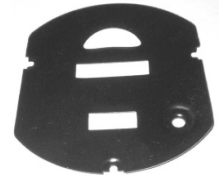

A17268A 28 - June 30 Oval speed
Price Ea. \$ 6.20

A17268C June 30 - 1931 Rnd Stewart Warner
Price Ea. \$ 6.80

A17268D June 30 - 1931 Round Waltham
Price Ea. \$ 7.85

Speedometer Decals

Replace your tired number decal with the right new one.



A17255A '28- June '30 Oval Faces Speedo
Price Ea. \$ 2.75

A17255B July '30-31 Round Faced Stewart Warner - 7/8" Wheel
Price Ea. \$ 2.75

A17255C July '30-31 Round Faced Waltham - 3/4" Wheel
Price Ea. \$ 2.75

A17255D July '30-31 Round Faced Northeast
Price Ea. \$ 3.00

Mike's "A" FORD-ABLE Parts

Speedometer Calibration by Wiley Higgins

While driving a Model A, the optimum driving speed is a steady 45 MPH. This speed moves you along at a good pace and helps keep you out of the way of most traffic, while not putting too much strain on your engine. If your Model A won't hold a steady 45 M.p.h., something needs to be corrected.

First of all, a Model A Speedometer usually is *not accurate* after over 60 years of use, even it has been rebuilt by a professional. Also, tire size and rear-end ratio have an effect. So, your speedometer may indicate a different speed than you are actually travelling down the road - either faster or slower.

The best method of determining the **actual speed** you are travelling is to **conduct a time/distance check**. Here's how:

1. Select a reasonably **straight and level stretch** of highway.
2. Use your digital or sweep second hand watch as a stop watch.
3. As you pass any **mile post** (remember, straight and level is best), start the stop watch or note the seconds on the sweep second hand.
4. **Hold the same, steady speed** for **one mile** to the *next* mile post, and **note how many seconds have elapsed**.
5. **Consult the chart** below to determine your true speed over the ground.
6. **Repeat steps 1. through 5.** above two or three times and get **an average**.
7. Adjust your speed over the ground slower or faster if you have a speedometer error to hold a steady 45 M.p.h.. For example, it takes **80 seconds** to go **1 mile** if your *true* ground speed is **45 M.p.h..**

SEC (1 Mile)	MPH	SEC (1 Mile)	MPH
102	35.3	86	41.9
101	35.6	85	42.4
100	36.0	84	42.9
99	36.4	83	43.4
98	36.7	82	43.9
97	37.1	81	44.4
96	37.5	80	45.0
95	37.9	79	45.6
94	38.3	78	46.2
93	38.7	77	46.8
92	39.1	76	47.4
91	39.6	75	48.0
90	40.0	74	48.7
89	40.5	73	49.3
88	40.9	72	50.0
87	41.4		



A17270A, B or C



A17275



A17271A, B, C or D

A17273S or R

A17275MB

A17274A or B

Speedometer Trip Stem

Nickel plated, knurled stem that pulls out on the Oval Speedo to set the odometer. Complete stem assembly with gear and retaining washer.



A17267

28 - Mid 1930

Price Set

\$ 20.00

Speedometer Grommet

This speedometer grommet fits in the firewall for the cable to go through, next to the choke rod.



A14567

28-31

Price Ea.

\$ 0.75

Gas Tank Speedometer Cable Grommet

This elongated grommet will help save your cable that runs under the gas tank in the tunnel to the speedo.



A9066R

28-29

Price Ea.

\$ 3.45

Mike's "A" FORD-ABLE Parts

Water Inlet - Speedo Cable & Cut-out Wire Clip

This wire clip was used in several places by Ford: for the water inlet and speedometer cable inside the firewall for all years; for the cutout wire on the firewall in 30-31.



A14577A 28-31

Price Ea. \$ 1.50

Firewall Wire Clip Bolt (Round)

This is the correct round head screw with lock washer to attach the wire clip to the firewall. Paint Black. Use with A14577A above & B Page Gen. 196.



A14577BR 28-31 12/24" x 1/2" screw & l.w.

Price Set/2 \$ 0.40

Speedometer Cables

Due to the fact that there are several manufacturers of interior cables and they are all being reproduced in different lengths, thereby causing a lot of confusion and problems we are no longer stock inner cables seperatly.

Replace your worn out speedometer cable with one of these new complete assemblies with steel ends. Mike's note: The early Ford cable was 1/2" in diameter while the latter was 1/4". The early gear on the drive shaft key has a round cable end with key up. The '30-'31 accepts the square cable.



Speedo End Square - Drive end Keyed
A17260AU 1928 - June '30

USA (oval)
Price Ea. \$ 33.95

Speedo End Square - Drive end Square
A17260B July '30 - 31

USA (round)
Price Ea. \$ 26.95

Black Vinyl Covered Speedometer Cable

An inexpensive alternative to the original flexible cables. For the round speedometer.



A17260C 30 - 31

Price Ea. \$ 15.00

Speedometer Lube

If your cable is OK but not turning smoothly, get this 7cc packet of graphite lubricant.



A17260L 28-?

Price Ea. \$ 2.95

Speedometer Support Clip

This support clip with mounting hardware goes on the frame rail to hold the speedometer cable.



5/16-24 x 11/16 Bolt, Lockwasher and Nut

A17265A 28-30 Oval speedo -

Price Ea. \$ 2.75

A17265B 30-31 Round speedo

Price Ea. \$ 2.75

Speedometer Drive Gears Only

Mike also has the drive gears available for both the 3.54 and 3.78 rear end gears.



A17270A 28-29 19 Tooth Gear used with 21" and 19" Tires

Price Ea. \$ 14.60



A17270B 30-31 18 Tooth Gear used 19" Tires

Price Ea. \$ 12.25

Extra High Speed Drive Gear

This gear goes in the speedo drive assembly that bolts to the bottom of the torque tube.

This is a high strength plastic 17 tooth gear that is used with the A4209XHS.

See Page Gen. 84.



A17270C 28-31 3:27 Ratio - 17 Tooth

Price Ea. \$ 29.95

Speedometer Housing Only

New Housings are now available.

Replace your worn housing with a new one.



A17271 28-31

Price Ea. \$ 41.00

Mike's "A" FORD-ABLE Parts

Speedometer Housing and Gear Assembly.

A complete new housing and gear assembly have been made from the FORD blue print. Includes gear, shaft and retainer. Order Gasket A17275 Separately.



- A17271A 1928 - June 1930 - Standard Gear with Round Hole Shaft for 21" Tire
Price Ea. \$ 56.95
- A17271B June 1930 - 1931 - Standard Gear with Square Hole Shaft for 19" Tire
Price Ea. \$ 56.95
- A17271C 1928 - June 1930 - High Gear with Round Hole Shaft for 21" Tire
Price Ea. \$ 56.95
- A17271D June 1930 - 1931 - High Gear with Square Hole Shaft for 19" Tire
Price Ea. \$ 56.95



A17270A, B or C



A17275

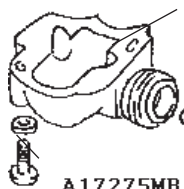

A17271A, B, C or D

A17273S or R

A17275MB

A17274A or B

Speedometer Gasket

Here's a gasket to get the proper gear mesh on the gear case.



- A17275 28-31 Price Ea. \$ 0.50

Speedometer Gear and Case Mount Bolts

Mike has this set of two fine-threaded bolts with lockwashers to bolt the speedometer gear and case to the torque tube.



- A17275MB 28-31 2 x 1/4" - 28 x 1" bolts & l.w.
Price Set/4 \$ 0.60

Speedometer Drive Gear Shaft

The end of the speedometer cable slides into this shaft in the gear/case assembly that bolts to the torque tube. Square end (S) and Round end (R) available.



- A17273R 1928 - June '30
Round ended cable / Oval Speedo
Price Ea. \$ 12.95



- A17273S July '30 - '31
Square ended cable / Round Speedo
Price Ea. \$ 12.95

Speedometer Shaft Retainer

This retainer goes into the threaded end of the gear and case to prevent the shaft from coming out.



- A17274A 28 - July '30 - Short Retainer
Price Ea. \$ 1.40



- A17274B July '30 - 1931 - Longer Retainer
Price Ea. \$ 1.40

Speedometer Snap Ring

This snap ring holds the speedometer drive gear and thrust washer in place on the drive shaft.



- A17286 28-37 Price Ea. \$ 0.75

Speedometer Thrust Washer

The thrust washer goes onto the drive shaft between the bearing and the speedometer drive gear.



- A17290 28-48 Price Ea. \$ 1.95

Mirror

Rear View Mirror Screws

This is the set of round headed machine screws to hold the mirror on the '28-'29 Coupe. 3 x 10-32 x 5/8 Round Head Screws with washers and nuts.
A17681AMB 28-29



Price Set/3 \$ 1.50

Rear View Mirror Mount Screws

This set of 3 chromed oval headed wood screws is used to mount the rear view mirror to the wooden header.
3 x #10 x 1" Oval Head Screw.



A17681BMB 30-31

Price Set/3 \$ 1.00

Inside Rear View Mirror Bracket Clip

These are the clips that hold the glass in place.



RAR252

Price Set \$ 4.95

Closed Car Mirror

This mirror has a black painted frame for the '28-'29 Coupe.



A17682AS 28-29 Black Price Ea. \$ 19.25

Closed Car Mirror

Mike has both the black and the Stainless rear view mirrors for the '30-'31 Coupe.



A17682BS 30-31 Black Price Ea. \$ 23.65
A17682SS 30-31 Stainless Price Ea. \$ 30.25

Rear View Mirror Glass

If your mirror is cloudy or the plating has worn off, replace it with one of these quality beveled mirrors. The smaller is correct but the larger gives better visibility.



A17704	Original Size - 2-1/2" x 4 1/2"	Price Ea.	\$ 5.50
A17704B	2-1/2" x 6"	Price Ea.	\$ 6.50

Coupe Clamp On Mirror (Peep Mirror)

This mirror fits any closed car by clamping onto the front of the door edge with two set screws. Chrome bracket with polished stainless mirror head. 4" Mirror.



A17741U 28-31 Price Ea. \$ 25.95

Coupe Peep Mirror

A chrome mirror that will easily attach in just minutes. Attach the two set screws to the top of the door. Can be used on either the driver or the passenger side door.



A17700PL 28-31 Price Ea. \$ 21.95

Coupe Hinge Mirror

This mirror with mounting pin fits all '28-'31 Closed Cars. Chrome bracket with polished stainless mirror head that adjusts. 4" Mirror.



A17741A	28-29	Left or Right	Price Ea.	\$ 39.05
A17741BL	30-31	Left	Price Ea.	\$ 39.05
A17741BR	30-31	Right	Price Ea.	\$ 39.05

Hinge Mirror Head Only

If the hinge arms are still in good shape and all you need to replace is the mirror - these are now available.



B17741MH 28-30 Price Ea. \$ 20.20

Mike's "A" FORD-ABLE Parts

Hinge Mirror Pin

This chrome finished pin will come with any new Hinge Mirror. A longer pin is required when installing mirrors on your car.



A17741HPI 28-31 Price Ea. \$ 2.45

Sidemount Mirror

This style sidemount mirror is attached with a leather strap.



B17700SM Price Ea. \$ 47.30

Windwing Mirror

This stainless mirror clamps to the windwing glass.



B17700WSS 28-31 Price Ea. \$ 27.50

Clock Mirrors

Mirror clocks are designed especially for the Model A Fords. Two of the outstanding features found in each Clock Mirror are the beautiful beveled quality mirror along with the accurate and dependable Quartz timepiece with its Arabic or Roman Numeral dial reflecting styles of the past. Comes with a 2 year manufacturer warranty. Please make sure that your bracket will adjust to hold a 2" high mirror. Shown on a bracket - this is NOT included.



A17705AS Silver Arabic
 A17705AG Gold Arabic
 A17705RS Silver Roman Numeral
 A17705RG Gold Roman Numeral
 Price Ea. \$ 95.00

Clock Mirror with Polished Edge

A beautiful replacement clock mirror with a polished edge. The mirror is not glass.



A17706 28-31 Price Ea. \$ 39.95



1930 Sport Coupe owned by Mr. J.W. Self

COUPE

Cowl Light

The following new parts are required to complete a restoration of your Cowl lights. This is only a guide - do not assume that this is all that is needed, all other parts need to be thoroughly checked.

1. Bulbs - A13466
2. Arms - A13301AR or BS
3. Screw Set - A13302BT
4. Mounting Plate - A13303
5. Mounting Plate Rivet - A13307
6. Rim Tab - A13305
7. Lens - A13308AR, D or DA
8. Gaskets - A13309A or C
9. Mounting Bolts - A13327
10. Pigtails - A13412
11. Sockets - A13338
12. Reflectors - A13315C
13. Rim Retainer Clips - A13316S
14. Cross Over Wire - A13302XO

Cowl Lights Arm Position Template

Drivers Side - 1930 - 31 Cowl Lights

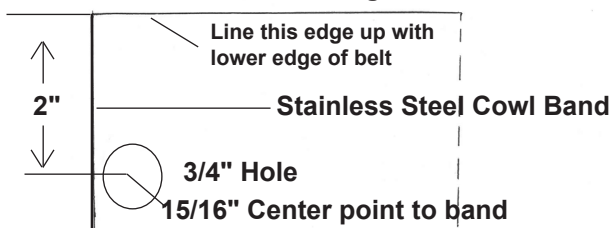

Passenger Side - 1930 - 31 Cowl Lights



Cowl Lights

Show Quality Cowl lamps, with Stainless buckets and Chrome arms. Correct glass, Reflector Bulbs, Wiring and Mounting Bolts.



A13302AR	28-29		Price Pair	\$ 155.00
A13302ES	30-31		Price Pair	\$ 115.00
A13302ARTS	28-29	6V w/turn signal	Price Pair	\$ 170.00
A13302ESTS	30-31	6V w/turn signal	Price Pair	\$135.00

Tail Light, Parking Light, Cowl, Instrument Panel & Dome Light Bulb

3 Candle Power as original.
10 Candle Power is available if you would prefer a brighter bulb.



A13466/3	3 CP	Price Ea.	\$ 0.90
A13466/10	10 CP	Price Ea.	\$ 0.90

Tail Light & Parking Quartz Bulbs

If you want a lot more light, use these direct replacements for your original bulbs. These are also known as "Ugly Bulbs".

Will not work with sealed beam or halogen headlights.



Tail Light and Parking: 50/20 Watt

B13466Q6	6 Volt	Price Ea.	\$ 13.75
B13466Q12	12 Volt	Price Ea.	\$ 11.00

Cowl Light Turn Signal Conversion Kit

This kit can convert both cowl lights to turn signals. It uses a double-filament bulb so it can be used as a parking light as well.



A13303TSAR	28-29	6V	Price Set	\$ 46.24
A13303TS	30-31	6V	Price Set	\$ 46.24
A13303TSBR	28-29	12V	Price Set	\$ 46.24
A13303TSB	30-31	12V	Price Set	\$ 46.24

Mike's "A" FORD-ABLE Parts

Cowl Light Turn Signal Bulb Only

The turn signal kit uses this double filament bulb. Offset tabs.



A13304/6	6 Volt	Price Ea.	\$ 2.10
A13304/12	12 Volt	Price Ea.	\$ 2.10

1928-1929 Cowl Light Arms

These chrome plated cowl light arms may be all you need if your light buckets are still in good shape.



A13301AR	28-29	Price Pair	\$ 82.50
----------	-------	------------	----------

1930-1931 Cowl Light Arms

Good chrome-plated arms for the '30-'31 cowl lights.



A13301BS	30-31	Price Pair	\$ 87.95
----------	-------	------------	----------

Cowl Light Arm Mounting Plate

This plate fits inside the bucket that the arm mounting screws go into.

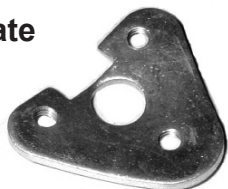

A13303	30-31	Price Ea.	\$ 3.05
--------	-------	-----------	---------

Cowl Light Arm Mounting Plate Rivet

This tubular rivet holds both the Mounting Plate (A13303) and the Rim Tab (A13305) to the bucket.



A13307	30-32	Price Ea.	\$ 0.60
--------	-------	-----------	---------

Cowl Light Mount Bracket

You'll need these brackets for inside the cowl section if you're installing cowl on your "A".

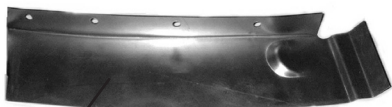

A13300BR	28-29	Price Pair	\$ 48.00
A13300BB	30-31	Price Pair	\$ 46.00

Cowl Light Marking Tool

This little tool takes the guesswork out of deciding where to drill new holes when installing a cowl light.

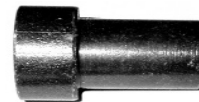

T13300X	28-31	Price Set	\$ 4.25
---------	-------	-----------	---------

Cowl & Tail Light Visor

Match up your cowl lights with a visor set. Just like the headlight set. See page Gen. 185 for Headlight visors.



A13001A	28-31	W/Jewel	Price Pair	\$ 23.00
---------	-------	---------	------------	----------

Cowl Light Rims

Highly Polished Stainless Steel rim.



A13306AR	28-29	Price Ea.	\$ 14.00
A13306B	30-31	Price Ea.	\$ 14.00

Cowl Light Rim Retainer Clips

This set of retainer clips will hold the lens to the rim for both your '30-'31 cowl lights.



A13316S	30-31	Price Set / 4	\$ 1.15
---------	-------	---------------	---------

Cowl Light Rim Tab

The rim screw goes into this small tab.



A13305	30-31	Price Ea.	\$ 2.55
--------	-------	-----------	---------

Cowl Light Lens

Clear lens.

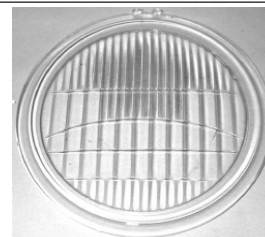

A13308AR	28-29	Price Ea.	\$ 6.55
A13308D	30-31	Price Ea.	\$ 4.35

Mike's "A" FORD-ABLE Parts

Amber Cowl Light Lens

If you've converted to a turn signal, these amber lenses will show up better.



A13308DA 30-31 Price Ea. \$ 6.75

Lens Gaskets

Replace yours to keep moisture out, extend the life of the bulb.

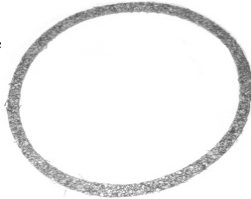

A13309A 28-29 Price Pair \$ 1.15
A13309C 30-31 Price Pair \$ 1.15

Cowl Light Reflector

This nice chrome reflector with bulb socket fits the '28-'29 cowl lights.



A13315AR 28-29 Price Ea. \$ 14.25

Cowl Light Reflector

Brand new, well polished reflectors for your '30-'31 cowl lamps.



A13315C 30-31 Price Ea. \$ 8.75

Cowl Light Screw Set

Stainless screws with lock washers to attach the cowl light to the cowl light bucket. 14 Piece Set. 6 x 10/32 x 1/2" & Washers



A13302BT 30-31 Price Set/14 \$ 2.00

Cowl Light Socket

Replacement socket for the '30-'31 cowl light bulb. Has the rivet, but no wire pigtail.



A13338 30-31 Price Set \$ 3.75

A13339 Rivet only Price Ea. \$ 0.50

Cowl Light Cross Over Wire

This wire connects the two cowls and runs a single wire to the wiring harness.

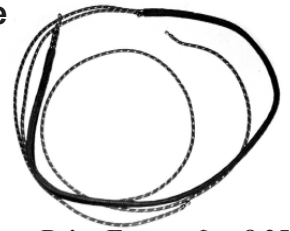

A13302XO 28-34 Price Ea. \$ 8.25

Cowl Light Wire Connector

This special ceramic connector was located at the base of the steering column to connect the cross over wire to the harness.



A13302C 28-31 Price Set \$ 7.95

Cowl Light Wood Blocks

These were used in '30-'31 to prevent denting. They fit between the cowl panel and the brace that the arm bolt goes through.



A13318 30-31 Price Pair \$ 3.95

Cowl Light Mount Bolt

This bolt has a hole through it for the cowl wire to go through. It mounts the light to the body.



A13327 30-31 Price Ea. \$ 1.25

Cowl Light Grommets

These grommets were used for '28-'29 only and go where the arms go through the panels.



A13324R 28-29 Price Pair \$ 3.80

Cowl Light Pigtails

Yellow with black tracer like the original, this wire goes through the socket and out the arm.



A13412 28-34 Price Pair \$ 3.50

Cowl Light Wire Supports

You'll need three of these to hold the cowl light cross over wire inside the firewall.

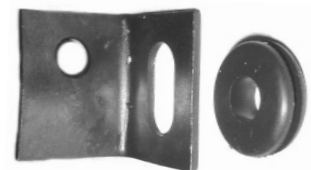

A14593 30-31 Price Set \$ 2.90

Mike's "A" FORD-ABLE Parts

Cowl Light Wire Support

Or you can use three of these to hold the wires for the cowl lights and the wipers.

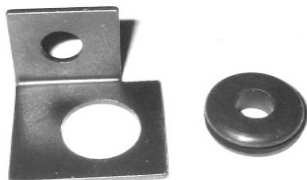

A14593A 28-29 Price Ea. \$ 2.25

Turn Signal Kit (6 Volt)

BE SAFE. Signal Stat. Add this complete turn signal kit directly to your tail lights. Kit includes the switch, fuse, flasher, flasher socket and complete instructions. Cowl conversion kit works with this one. If you do not have cowl lights you will need to install front turn signal lights of some sort. Comes with instructions. 11 Piece Set. For more turn signals items see our Turn Signal Section on Page Coupe 70.



A13310A 28-31 Price Set/11 \$ 58.95

Turn Signal Flasher

6-Volt flashers are hard to find; you'll need this if you have added turn signals to your A.



A13311 28-31 Price Ea. \$ 5.25

Complete Turn Signal Kit (6 or 12 Volt + or -)

Now you can have super bright Amber LED turn signals for your "A"! Kit includes super bright LED turn signals, stainless steel brackets, controller and wire. The easy hookup connects to 6 Volt OR 12 Volt cars with negative or positive ground without even flipping a switch. The kit features all solid state components (there are no turn signal flashers to wear out and the LED's will last for over 25 years!). The whole kit is bolted on so you don't have to permanently modify your car. Slim line turn signals mount to bumper clamp bolts and have a one wire hook up. Each turn signal is individually short circuit protected so if one wire shorts to the chassis, only that one light won't come on. Eliminate the short and the turn signal will work again. Also has a hazard light function and is backed by a one year manufacturer's warranty. 20 Piece Set.

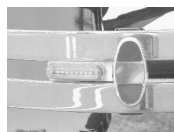
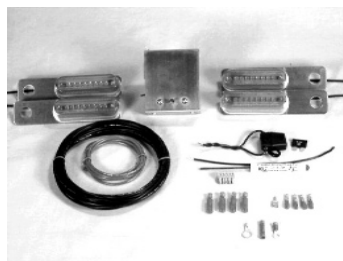

A13311A 28-31 Price Kit/20 \$ 169.95



1930 Sport Coupe owned by Mr. J.W. Self

COUPE

Tail Light

Specifications:

Parking, Tail: 3 CP, single contact Mazda 63
 Stop: 21 CP, single contact Mazda 1129

The following new parts are required to complete a restoration of your Tail Lights. This is only a guide - do not assume that this is all that is needed, all other parts need to be thoroughly checked.

1. Tail Light Rim - A13448SS
2. Tail Light Gasket Set - A13461
3. Replacement Screw Set - A13405SK
4. Lens - choose your style - A13450
5. Snap Rings - A13456
6. Licence Plate Lens - A13445
7. Retainer clips - A13446S
8. Tail Light socket Set -A13412S
9. Reinforcing Plate - A13463
10. Bracket to Fender Mounting Bolts - A13474B, SS
11. Tail Light Bracket/Fender Rubber Pad - A13520
12. Tail Light / Stop Light Bulbs - A13465 & A13466
13. Licence Plate Bolt - A13407MB
14. Stoplight Switch - A13480A or B

Duo-Lamp Tail Light Repair Parts

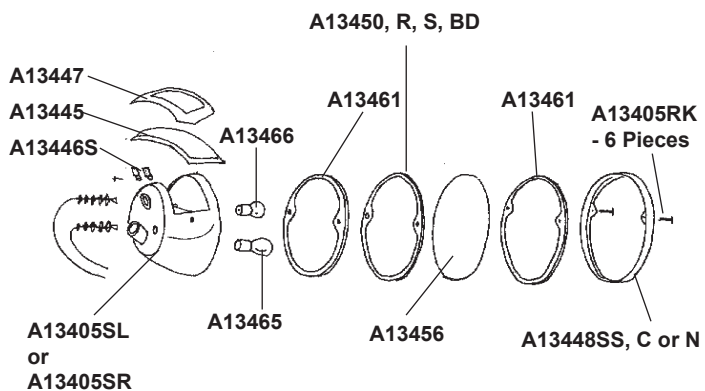

"Duolamp" Tail Light

Copy of the original. Stainless Steel. Commercials used black painted - left side has white lens - right side, no lens. Complete with half amber lens, bulbs and wiring - also includes bracket screws.



A13405SL	28-31	Left	Price Ea.	\$ 37.95
A13405SR	28-31	Right	Price Ea.	\$ 37.95

"Duolamp" Tail Light Replacement Screw Kit

This is all of the screws that you will need to refurbish your Tail light. 1 Set per Tail Light.



A13405SK	28-31	Price Set/8	\$ 3.65
----------	-------	-------------	---------

Stop Light Bulb

21 Candle Power.

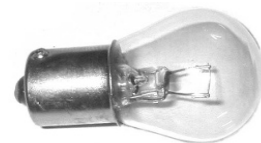

A13465	28-31	Price Ea.	\$ 1.00
--------	-------	-----------	---------

Tail Light, Parking Light, Cowl, Instrument Panel & Dome Light Bulb

3 Candle Power as original.

10 Candle Power is available if you would prefer a brighter bulb.



A13466/3	3 CP	Price Ea.	\$ 0.90
A13466/10	10 CP	Price Ea.	\$ 0.90

Quartz Bulbs

If you want a lot more light, use these direct replacements for your original bulbs. These are also known as "Ugly Bulbs".



Tail Light and Parking: 20 Watt

B13466Q6	6 Volt	Price Ea.	\$ 13.75
B13466Q12	12 Volt	Price Ea.	\$ 11.00

Stop Light: 50 Watt

B13465Q6	6 Volt	Price Ea.	\$ 13.75
B13465Q12	12 Volt	Price Ea.	\$ 11.00

Mike's "A" FORD-ABLE Parts

Cowl & Tail Light Visor

Match up your Cowl & Tail Lights with a visor set. Just like the headlight set. See Page Gen. 185.



A13001A 28-31 W/Jewel Price Pair \$ 23.00

Stainless Tail Light Rim

We only keep the stainless as these will not rust.



A13448SS 29-31 Price Ea. \$ 5.75

LED Replacement Tail Light - All Red and Half Amber

Use this brand new product in your duo lamp housing and have the advantage of LED Tail lights. 6 or 12 Volt.

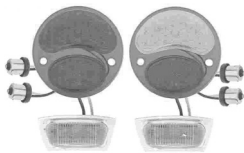

12 Volt
 A13453 Right - Half Amber
 A13453R Right - Red
 A13454 Left - Half Amber
 A13454R Left - Red Price Ea. \$ 40.00

6 Volt
 A13455 Right - Half Amber
 A13455R Right - Red
 A13457 Left - Half Amber
 A13457R Left - Red Price Ea. \$ 43.00

Tail Light All Red Lens

If your state does not allow amber stop lights, this all red lens is available.



A13450R 1928 - Sept. '29 Price Ea. \$ 5.45

Tail Light Half Amber Lens

This lens has a red section for the tail light and amber for the stop light.



A13450 Sept. '29 - till end '31 Price Ea. \$ 6.00

Tail Light Stop Lens

This is a glass red lens with the letters "STOP" molded in amber.



A13450S 29-31 Price Ea. \$ 8.95

Tail Light Blue Dot Lens

This is the all-red lens with the blue dot already installed in the stop section.



A13450BD 29-31 Price Ea. \$ 13.75

Tail Light Blue Dot

For the DIYer, you can fit your own blue dot in with this. It has a chrome rim. 1 Piece Set. Need 1 Set for one lens.



A13450D 28-31 Price Set \$ 4.95

Tail Light Snap Ring

This was used to hold the lens in the tail light rim. The sequence was the rim gasket, then the lens, then the snap ring.

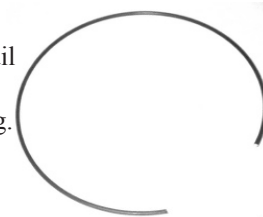

A13456 29-31 Price Ea. \$ 0.95

Tail Light Gasket

This goes between the face of the lens and the rim but many put one on both sides of the lens to reduce the risk of cracking.



A13461 29-31 Price Ea. \$ 0.60

License Plate Lens

This is the clear lens for the left side tail light to illuminate the license plate.



A13445 29-32 Price Ea. \$ 3.45

License Lens Gasket

This is the gasket for the clear license lens.



A13447 29-32 Price Ea. \$ 0.50

License Lens Retainer Clips

Two retainers and screws to hold the license lens in the tail light.

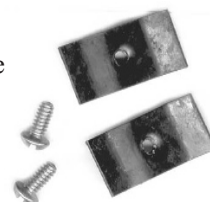

A13446S 28-32 4 piece set Price Set/4 \$ 1.50

COUPE

Mike's "A" FORD-ABLE Parts

Tail Light Loom

This is what Ford used to protect the tail light wires from the elements. Extends from tail light through fender to under body.



A13412L 28-31 Price Ea. \$ 1.25

Tail Light Wire Clip

This clip holds the tail light loom to the fender.

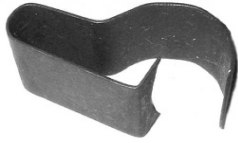

A14565 28-31 Price Ea. \$ 2.65

Tail Light Socket

Press this socket into the tail light bucket to hold the bulb.

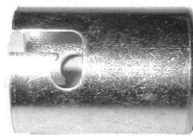

A13412S 29-31 Price Ea. \$ 0.65

Double Contact Socket

These universal style sockets are used to convert any lamp to a dual filament bulb that can be used for turn signals. Use staggered pin bulbs. Some modification to your lamp will be needed to accept these.



A13412DC 28-31 Price Ea. \$ 8.10

Tail Light Wire Pigtails

This pigtail with springs and washers extends out the back of the tail light to make your connection. Correct fabric and colors. Black for Taillight / Green for Stop Light.



A13412/13 29-48 Price Pair \$ 3.60

Tail Light Cross Over Wire

This cross-over wire allows you to add a right tail light and then connect the two tail lights to the main harness.



A14423XO 28-31 Price Set \$ 9.00

Tail Light Reinforcing Plate

Lessen the risk of damaging your fender by using this plate under the fender to attach your tail light bracket.



A13463 29-31 Price Ea. \$ 3.25

Tail Light Bracket Pad

Protect your fender from metal to metal vibration with this rubber pad which fits between the fender and the tail light bracket.



A13520 29-31 Price Ea. \$ 2.00

Tail Light Bracket

These brackets are ready to mount. Same gauge steel Ford used. Used with teacup style tail lights.



A13471R	29-31	Right	Price Ea.	\$ 9.85
A13471L	29-31	Left	Price Ea.	\$ 9.85
A13471RC	29-31	Right - Chrome	Price Ea.	\$ 13.95
A13471LC	29-31	Left - Chrome	Price Ea.	\$ 13.95

Tail Light Bracket Bolts

This set of 3 special carriage bolts and nuts is used to bolt the tail light bracket to the fender. Bolts have large heads. 3 X 1/4-20 5/8 Bolt with Large Head.



A13474BK	29-31	Price Set/6	\$ 1.75
A13474SS	29-31	Stainless steel Price Set/9	\$ 3.25

Mike's "A" FORD-ABLE Parts

Rear License Bracket

An identical reproduction of the original.



A13406D 28-31 Price Ea. \$ 6.50

A13406SS 29-31 Polished Stainless Steel
Price Ea. \$ 15.95

Rear License Plate Special Bolts

The nuts and bolts necessary to mount your license plate.



A13407MB 28-31
Price Set/4 \$ 4.35

License Plate Reflector Bolts

A reproduction of an aftermarket accessory. These bolts are sold in pairs and available in four different colors.



A13408 Blue
A13409 Amber
A13410 Green
A13411 Red
Price Pair \$ 1.00

Stop Light Switch

The early A's used this type switch which mounted on the transmission. Don't forget to order your link A13507R. Best Quality.



A13480A 28-30 Price Ea. \$ 5.95

Stop Light Switch Link

This is the metal link for the A13480A stop light switch.



A13507R 28-29 Price Ea. \$ 1.45

Stop Light Switch

A few '29's had this but mostly for '30-'31's. This bolts to the cross member of the frame. Needs A2465B (Page Gen. 50) Pedal to Brake shaft rod. Best Quality.

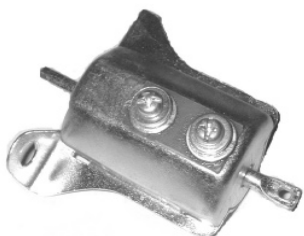

A13480B 30-31 Price Ea. \$ 5.00

Stop Light Switch Mounting Bolts

Here are the bolts, nuts, and lock washers to mount the '30-'31 style stop light switch to the cross member.

2 - 1/4-20 x 1/2" Bolts, lockwashers and nuts.



A13480MB 30-31
Price Set/6 \$ 0.55

1928 / 1929 Stoplight Switch Mounting

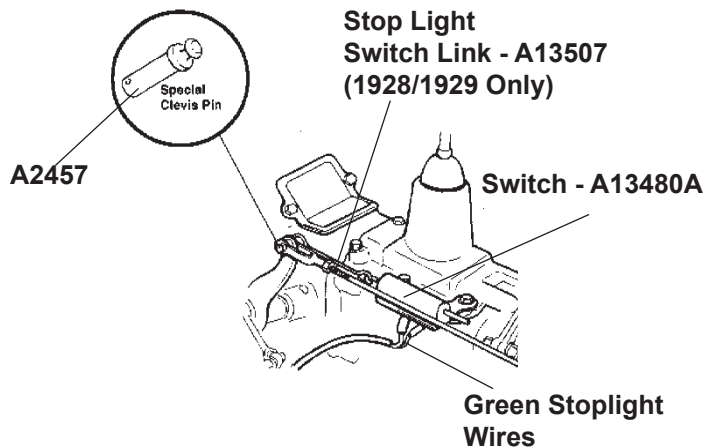

1930 / 1931 Stoplight Switch Mounting

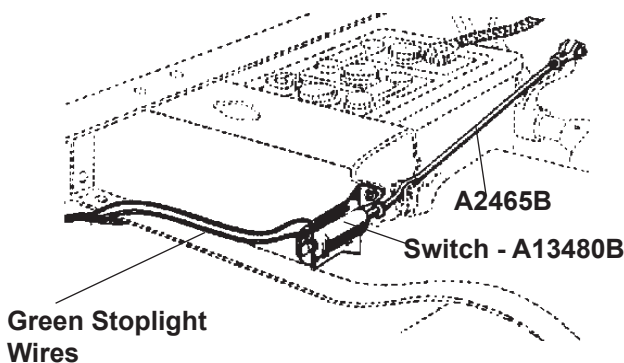

Thanks to Les Andrews for the use of his drawings.

See Page Coupe 70 for the complete Turn Signal Section.

Mike's "A" FORD-ABLE Parts

Custom LED Third Brake Lights

Made in USA. Custom LED Third Brake Light fits in the back window of cars and trucks. Strong, twin suction cups attach the rugged, black ABS case to the glass in the back window. Two wire, easy hookup works with 6V or 12V negative or positive ground vehicles. Electronics feature all solid state components (nothing to wear out and the LEDs should last for over 25 years!). No permanent modifications to your car are required. Kit comes with Third Brake Light, harness, connectors, mounts, and suction cups. Logo Lites Custom LED Third Brake Lights are backed by a one year manufacturer's warranty.



A13312S	STOP	Price Kit	\$ 72.00
A13312A	1928	Price Kit	\$ 72.00
A13312B	1929	Price Kit	\$ 72.00
A13312C	1930	Price Kit	\$ 72.00
A13312D	1931	Price Kit	\$ 72.00

A custom Third Brake Light is available. Any 4 Characters of your choice is available, eg MIKE.

A13312O	Special 4	Price Kit	\$ 99.65
---------	-----------	-----------	----------

Do you like the
sound of FREE
Shipping??

Order online
and get a 5%
Discount -
this could cover
your shipping
costs!!

Drum Tail Light

Stop Light Bulb

21 Candle Power.

See Quartz Bulbs on Page Coupe 63.



A13465 28-31 Price Ea. \$ 1.00

Tail Light, Parking Light, Cowl, Instrument Panel & Dome Light Bulb

3 Candle Power as original.

10 Candle Power is available if you would prefer a brighter bulb.



A13466/3 3 CP Price Ea. \$ 0.90
 A13466/10 10 CP Price Ea. \$ 1.25

Complete Drum Tail Light

Top quality reproduction with the black bracket and nickel body. Used on '28's and early '29's.

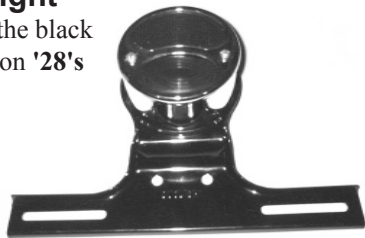

A13405DPL - Passenger - Left - Nickel Ea. \$ 110.00
 A13405DPR - Passenger - Right - Nickel Ea. \$ 110.00

1) Assemble contact-insulating washers and rivets. Seat down & upset rivet so that contact can be rotated.

2) Assemble divider plate using 3/16" rivets.

3) To install backing plug; tap into hole from front with slot turned clockwise until slot is level with plate.

Rotate contact and plug so contact enters small slot in brass plunger. When aligned tap in until locking plunger enters hole in rear of plate.

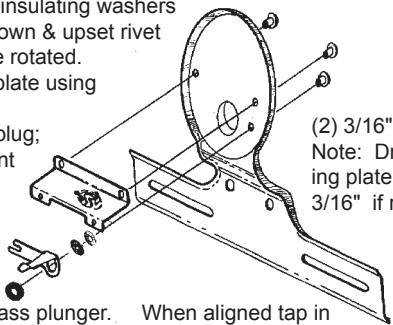

(2) 3/16" Rivets
 Note: Drill backing plate 3/16" if required.

Drum Tail Light License Bracket

Top quality steel reproduction. Paint Black.



A13406AR 28-29 Price Ea. \$ 28.50

Drum Tail Light and License Bracket to Support Bracket Bolts



Two 5/16-24 x 11/16 Hex Bolts, L/w's and Nuts.

A13607 28 - Early '29 Price Set \$ 0.50

Drum Tail Light Support Bracket to Body Bolts



Two 5/16-24 x 5/8 Hex Bolts and L/w's.

A13673 28 - Early '29 Price Set \$ 0.50

Drum Tail Light Bracket

Used on drum tail lights.

These were used from 1928-July 1929 on Coupes.



A13470AL 28-29 Left Price Ea. \$ 17.95
 A13470AR 28-29 Right Price Ea. \$ 23.50

Drum Tail Lamp Socket

This is the bulb socket for the '28-'29 drum tail light.

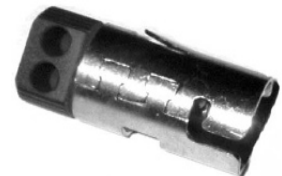

A13410A 28-29 Price Ea. \$ 34.98

Drum Tail Light Divider Plate

This divider plate separates the tail lamp from the stop lamp sections on the drum style tail light.

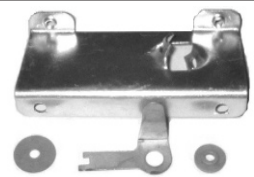

A13406DP 1928 - Early 1929 Price Set \$ 21.75

Drum Tail Light Body

This is a very good nickel-plated reproduction. Body only.



A13440DBPL - Passenger - Left - Nickel
 A13440DBPR - Passenger - Right - Nickel
 1928 - Early '29 Price Ea. \$ 31.00

Mike's "A" FORD-ABLE Parts

Drum Retainer Screws

This is the special hardware necessary to hold the tail light body and lens on.



A13441BT 28-29

Price Set/6 \$ 5.75

Drum Stop Face Plate

This steel insert with the word "STOP" fits behind the red lens.



A13442AR 1928 - Early '29

Price Ea. \$ 6.30

Drum White License Lens

For the '28 drum tail light only.

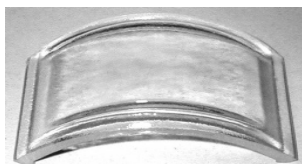

A13445AR 1928 - Early '29 Price Ea. \$ 10.00

Drum Retainer Clips

Two retainers and screws to hold the license lens in the drum tail light.

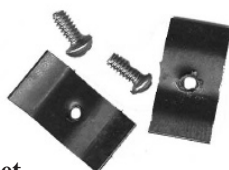

A13446SA 28-31 4 piece set

Price Set/4 \$ 1.50

Drum License Lens Gasket

This is the gasket for the '28 license lens on the drum tail light.



A13447AR 1928 - Early '29 Price Ea. \$ 0.75

Drum Red Lens

This is an all-red lens for the '28 drum tail light.



A13450AR 28-29

Price Ea. \$ 7.60

Drum Tail Light Lens Gasket

This is the round gasket for the drum tail light.



A13461AR 1928 - Early '29 Price Ea. \$ 0.60

Drum Tail Light Wire Clip

You'll need two of these to hold the wire to the tail lamp bracket on the '28 drum tail light.



A14595 1928 - Early '29 Price Pair \$ 2.95

Drum Tail Light Extension Wire

This wire goes from the drum tail light to the main wiring harness.

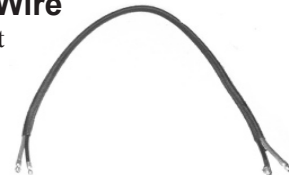

A14423AR 28-29 Price Ea. \$ 5.65

Order Online Now and Save 5%

Visit our website for all your Model "A" needs.



www.mikes-afordable.com

Turn Signals

Turn Signal Kit (6 Volt)

BE SAFE. Signal Stat. Add this complete turn signal kit directly to your tail lights. Kit includes the switch, fuse, flasher, flasher socket and complete instructions. Cowl conversion kit works with this one. If you do not have cowl lights you will need to install front turn signal lights of some sort. Comes with instructions. 11 Piece Set.



A13310A 28-31 Price Set/11 \$ 58.95

Turn Signal Flasher

6-Volt flashers are hard to find; you'll need this if you have added turn signals to your A.



A13311 28-31 Price Ea. \$ 5.25

Turn Signal Lamps

If you are using the A13310A Turn Signal Kit these are the turn signal lights that will fit between the front and rear bumper bars. No modifications needed. Don't forget to buy extra wire by the foot see wiring section on Page Gen. 198. Available for both 6 & 12 Volts. Use on front and rear.

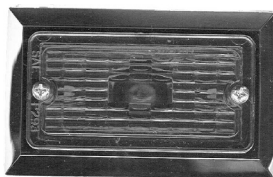

A13405T6	6 Volt - Amber	Price Ea.	\$ 20.95
A13405T6R	6 Volt - Red	Price Ea.	\$ 20.95
A13405T12	12Volt - Amber	Price Ea.	\$ 19.95
A13405T12R	12 Volt - Red	Price Ea.	\$ 19.95

LED Replacement Tail Light - All Red or Half Amber

Use this brand new product in your duo lamp housing and have the advantage of LED Tail lights. 6 or 12 Volt.

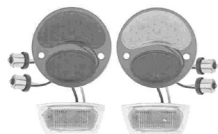

12 Volt			
A13453	Right - Half Amber		
A13453R	Right - Red		
A13454	Left - Half Amber		
A13454R	Left - Red	Price Ea.	\$ 40.00
6 Volt			
A13455	Right - Half Amber		
A13455R	Right - Red		
A13457	Left - Half Amber		
A13457R	Left - Red	Price Ea.	\$ 43.00

Complete Turn Signal Kit (6 or 12 Volt + or -)

Now you can have super bright Amber LED turn signals for your "A"! Kit includes super bright LED turn signals, stainless steel brackets, controller and wire. The easy hookup connects to 6 Volt OR 12 Volt cars with negative or positive ground without even flipping a switch. The kit features all solid state components (there are no turn signal flashers to wear out and the LED's will last for over 25 years!). The whole kit is bolted on so you don't have to permanently modify your car. Slim line turn signals mount to bumper clamp bolts and have a one wire hook up. Each turn signal is individually short circuit protected so if one wire shorts to the chassis, only that one light won't come on. Eliminate the short and the turn signal will work again. Also has a hazard light function and is backed by a one year manufacturer's warranty. 20 Piece Set.

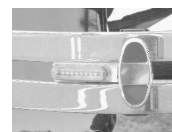
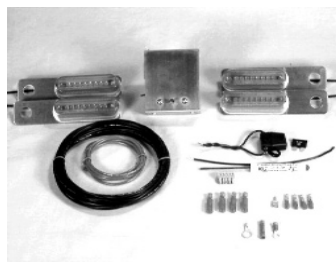

A13311A 28-31 Price Kit/20 \$ 169.95

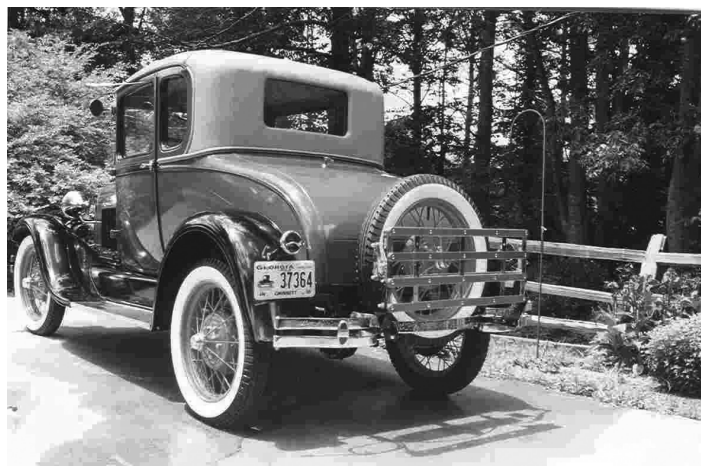

1929 Special Coupe restored by Mike's in 1994.

COUPE

Dash & Dome Light

Specifications:

Instrument Panel:	3 CP, single contact, Mazda 63
Dome:	3 CP, single contact, Mazda 63
Commercial Dome:	15 CP, single contact, Mazda 87

Dash Light

This mounts in the middle of the dash on the '28-'30 A's with the oval speedometer. Attach the dash wire to the charge post on the amp meter.



A13708AR 1928 - June 1930 Price Ea. \$ 22.55

Dash, Dome, Cowl & Parking Light Bulb

3 Candle Power as original.
10 Candle Power is available if you would prefer a brighter bulb. See Page 213 for Quartz Bulbs.



A13466/3 3 CP Price Ea. \$ 0.90
A13466/10 10 CP Price Ea. \$ 0.90

Dash Light Cover

This is the cover only for the dash light on the '28-'30 oval speedometer. Only fits repro Dash light.



A13705 28-30 Price Ea. \$ 13.70

Dash Light Bracket

If your dash light mounts up under the dash, you'll need one of these brackets.



A13706BRC 30-31 Closed car. Price Ea. \$ 1.95

Dash Lamp Cap Only

For Closed Cars.
Switch Type.

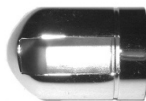

A13705B 30-31 Price Ea. \$ 13.50

Dash Light (Excellent Replacement)

This is the dash lights for the '30-'31 A's with the round speedometer; this mounts under the dash rail. See **A13710** for dash light armored cable.

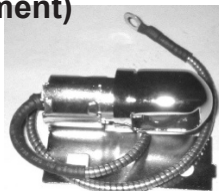

A13708B June '30 - till end '31 Closed Car Price Ea. \$ 24.15

Dash Light Armored Cable

This 1/8" diameter single strand cable is used for the dash light but can also be used for a sport light. Cut and sold in 12" lengths.

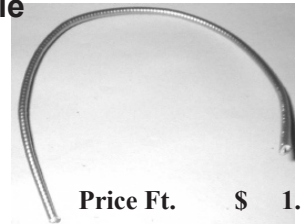

A13710 28-31 Price Ft. \$ 1.65

Dome Light Assembly (With Switch)

This is the dome light with switch. 6 Volt bulb installed. '30-'31 Deluxe Coupe.



A13771WS 30-31 Price Ea. \$ 49.50

Dome Light Switch on Rim

A copy of the original switch and lever that's located on the rim of the round Dome Light (**A13771**).



A13771SW 28-31 Price Ea. \$ 14.95

Dome Light Assembly (Without Switch)

Same unit as **A13771WS** except this has no switch. You will have to purchase **A13770** (Page Coupe 72) Cover and **A13769** (Page Coupe 72) Switch and **A13778** (below) Wire.



A13771 30-31 Price Ea. \$ 45.65

Dome Light Snap Ring

This little cadmium plated ring can be hard to find but you'll need it to hold the lens onto the dome light.

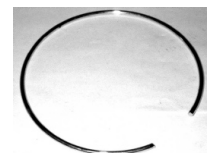

A13771C 30-31 Price Ea. \$ 5.50

Dome Light Lens

Milky-colored replacement lens for the round dome light. Fits **A13771WS**.



A13771G 30-31 Price Ea. \$ 8.50

Dome Light Wire

This is the correct 16 gauge cloth covered wire; black with a blue tracer. Order per foot needed for your vehicle. Wire starts at the drivers side of the terminal box, up the windshield post, half way across the header and back to the dome light. Make sure you run a ground wire from the light to the side of the body.



A13778 Price Ft. \$ 0.65

Mike's "A" FORD-ABLE Parts

Dome Light Switch and Cover

This replacement switch with cover mounts on the door pillar.



A13770 28-31 Cover Price Ea. \$ 2.75

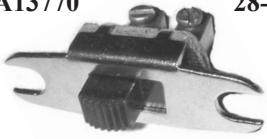

A13769 28-31 Switch Price Ea. \$ 8.75

See Page Coupe 12 for Dome Light Wood Block.

See Page Gen. 198 for Wire - Sold by the Foot.

See Page Gen. 189 for Ignition Switch & Dash Panels & Parts.



1929 Business Coupe

Garnish Moldings & Frames

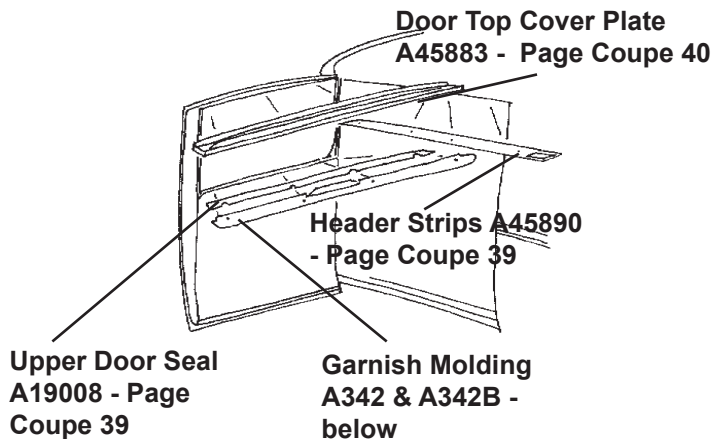

Steel Garnish Molding

These steel reproduction garnishes are really good quality.



A342A	28-29	Coupe - 26 15/16"		
			Price Pair	\$ 80.00
A342B	30-31	Coupe - 26"		
			Price Pair	\$ 80.00

Garnish Molding Screws

These screws are 10/32 x 1/2 to attach the garnish molding to the door.



A342S	28-31		Price Ea.	\$ 0.15
-------	-------	--	-----------	---------

Coupe Rear Window Frame

Steel Frame for the '30-'31 Coupe rear roll down window. See Page Coupe 28 for Glass.

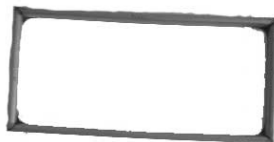

A91201	30-31		Price Ea.	\$ 86.50
--------	-------	--	-----------	----------

Sport Coupe Rear Window Frame

The rear frame for the '28-'31 Sport Coupe. The outside is polished stainless and the inside is powder coated tan. Frame is 9 9/16" tall & 20 5/8" wide.



A47096SP	28-31		Price Ea.	\$ 189.00
----------	-------	--	-----------	-----------

Sport Coupe Rear Window Frame Glass

This is the Sport Coupe Rear Window Frame Glass. This is to fit the A47096SP Frame.



A47096G	28-31		Price Ea.	\$ 35.00
---------	-------	--	-----------	----------

Rear Window Frame

Steel window frames, exact copy of Fords from the Ford Blue Prints are now available for the following vehicles:



'28-'31 Coupe
'28-'29 Special Coupe
For Glass see Page Coupe 28.
A47096A 28-31

Price Ea. \$ 79.50

Rear Window Screws

Hold your window frame in place with this Set of Twelve #10 x 1 Oval Chrome Plated Wood Screws.



A48251	28-31		Price Set	\$ 1.20
--------	-------	--	-----------	---------

COUPE

Mike's "A" FORD-ABLE Parts

Sill Plates

Sill Plates

These die stamped aluminum sill plates with the Ford script fit under the door.



A46480AS 28-31 Coupe 8" Price Pair \$ 11.30

Zinc Sill Plates

These are authentic zinc sill plates like Ford originally used.



A46480AOR 28-31 Coupes 8" Price Pair \$ 17.00

Sill Plate Screws - Coupe

Four screws will mount the Coupe sill plates; #10 x 1/2" Screws.



A46480MB 28-31 Price Set/8 \$ 0.65

COUPE

SEAT PARTS

Seat Adjuster Installation

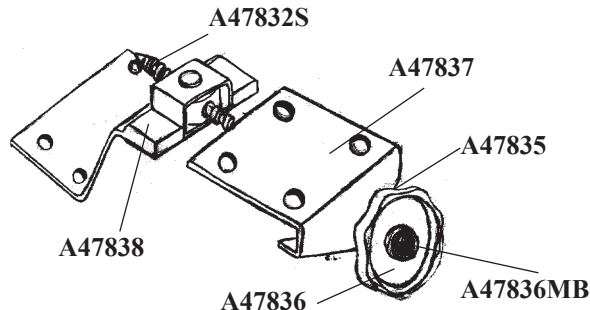

Seat Adjuster Bolt

This special threaded bolt is used to adjust the screw-type adjustable seat, by moving it backwards or forwards. The seat adjuster nut (A47832N) goes on this. Original Screws will not fit repro. nuts, its best to replace the bolt and nut. 5 1/2" Long. Used on: '30-'31 Coupes



A47832S 30-31 Price Ea. \$ 18.95

Seat Adjuster Nut

This is the special round nut. Used on: '30-'31 Coupes. This nut will only fit the repro screw A47832S.



A47832N 30-31 Price Ea. \$ 12.95

Seat Adjuster Washer

This washer goes on the head of the seat adjuster bolt before the bolt goes through the bracket at the front of the seat. This washer is made of nylon for smoother operation, not brass like the original. Used with the A47832S.



A47835 30-31 Price Ea. \$ 1.80

Seat Adjuster Knob

This chrome-plated round knurled knob is for the front seat adjustment. Used on: '30-'31 Coupe & Sport Coupe

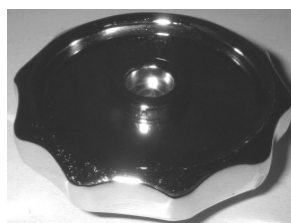

A47836 29-31 Price Ea. \$ 14.35

Seat Adjuster Handle

This brass chrome-plated style handle was used on:

Mid '31 - End Coupes

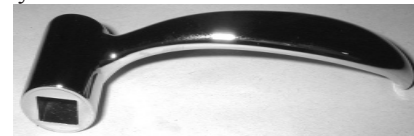

A47836B 30-31 Price Ea. \$ 12.95

Seat Adjuster Handle Screw

This screw holds the round seat adjustment knob A47836 to the seat adjustment bolt A47832S.



A47836MB 30-31 Price Ea. \$ 0.70

Seat Adjuster Bracket

Mounts onto the bottom of the wood frame. This holds the seat adjusting screw in place, so that seat can be moved back and forth. Used on: 1930 - Mid 1931 Coupes, Sport Coupes



A47837 1930 - Mid 1931 Price Ea. \$ 26.95

A47836B Seat Adjuster Installation

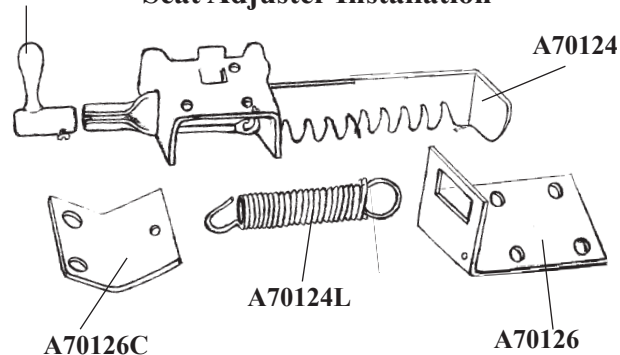

Seat Adjuster Bracket and Nut

An "L" shaped bracket that is located on the body cross member and extends up the front seat frame. A47832N is installed. For the screw type seat adjuster. Used on 1930 to mid 1931 on Coupes, Sport Coupes.



A47838 1930 - Mid 1931 Price Set \$ 51.95

Seat Align Clip

Used on '28-'29 Coupes this clip screws onto the backrest wood and is what the seat back hangs onto.



RAR210 28-29 Price Ea. \$ 4.95

Mike's "A" FORD-ABLE Parts

Seat Adjuster

A saw-tooth style seat adjuster. Mounting bracket is at the front of the seat. Mounting bracket to the floor is not included. See A70126, A70126C. Used on:

Late 1931 Coupe



A70124 1931 Price Ea. \$ 63.00

Seat Adjuster Spring

This 6" spring is used with the saw-tooth style adjuster - A70124.



A70124L 1931 Price Ea. \$ 4.40

Seat Track Assembly

Mount this sliding track assembly with bolts and spacers provided on top of the seat frame Used on:

'30-'31 Coupes



A321BT 30-31 Price Set \$ 52.00

Seat Stop Block

Attach this block to the bottom of the wood that the cushion spring is upholstered to. When the spring is in position the block sits just behind the front edge of the seat riser to keep the cushion in place. Used on '28 - '29 Coupes.



RAR205 28-29 Price Ea. \$ 10.50

Seat Latch Assembly

This is the bracket for the saw-tooth style seat adjuster. Mount it to the floor under the front of the seat.

Used on late Deluxe Coupes.



A70126 1931 Price Ea. \$ 28.00

Seat Spring Clip

This clip holds the adjuster spring on the saw-tooth seat adjuster. It screws into the back bottom edge of the front seat assemblies. Used on late 1931 Coupes.



A70126C 1931 Price Ea. \$ 11.00

Seat Cushion Dowel

Holds seat cushion onto the body subrail so that cushion (springs) will not move. Need 2 per seat.

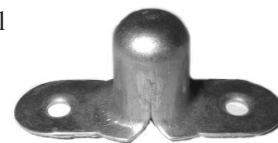

A121D 28-31 Price Ea. \$ 10.25

Front Seat Stop Guide

Used on Coupes. This is a front seat stop guide. They go under the seat and attach to the sides of the wood frame. This stops the seat bucket from unscrewing when adjusted. 2 Required.



RAR267 1928 - Early '31 Price Ea. \$ 4.95

COUPE

Seat Springs

Note: All seat springs are shipped directly from the manufacturer. We do not stock springs. Please make sure you know exactly what year and Model you have as the manufacturer will not take springs back. Oversize shipping charges do apply. 1928 - 1929 has rounded edges and the 1930 - 1931 has squared edges with smaller springs.

28 - 29 Coupe & Sport Coupe

S301	Front Cushion	\$ 78.25
S302	Front Backrest	\$ 61.75
S303	Rumble Cushion	\$ 64.25
S304	Rumble Backrest	\$ 83.75

30 - 31 Coupe & Sport Coupe

S305	Front Cushion	\$ 76.25
S306	Front Backrest	\$ 61.75
S307	Rumble Cushion	\$ 64.25
S308	Rumble Backrest	\$ 83.75
S306L	Late 1931 Backrest	\$ 83.75

Upholstery

DUE TO THE ENORMOUS SELECTION OF UPHOLSTERY CHOICES FOR THE MODEL A'S - WE HAVE LEFT THE UPHOLSTERY SECTION TOGETHER.

SEE PAGE Gen. 220 FOR COUPE INTERIOR KITS.

SEE PAGE Gen. 229 FOR COUPE RUMBLE PANELS AND UPHOLSTERY.

SEE PAGE Gen. 230 FOR COUPE TOPS AND PADS

COUPE

Mike's "A" FORD-ABLE Parts

Notes

Notes

COUPE

Mike's "A" Ford-able Parts

Order Form

124 Model A Drive
 Maysville, GA 30558
 Phone: (706) 652-3866 Fax: (706) 652-2492
 EMail - mike@mikes-afordable.com

Date: _____ Year & Body Style of Car _____

Customer Information	Shipping Address (if different) No P.O. Boxes
Name _____	Name _____
Phone () _____	Phone () _____
Address _____	Address _____
City _____	City _____
State _____ Zip _____	State _____ Zip _____
Email _____	Email _____

Quantity	Part #	Description	Price Each	Total Price

Would you like to have a copy of your invoice e-mailed to you? Have your shipping date and tracking information right at your fingertips. Please be sure to print your e-mail address clearly.				
Method of Payment _____ Check or Money Order _____ Visa _____ Master Card _____ Discover			GA Residents add 7% Tax See formula in The Fine Print	Total
Acct # _____ Expiration Date _____ 3 Digit Security Code / Rear _____				Tax
				Shipping
				Total Enclosed

Give us a call - 1-888-TRY-MIKE (879-6453) **Have an "A" Day!**

Mike's "A" Ford-able Parts

Quantity	Part #	Description	Price Each	Total Price
----------	--------	-------------	------------	-------------

Sub Total

GA Residents add Tax

Tax

See formula in The Fine Print

Shipping

Total Enclosed