

Roadsters & Phaetons

- 1928 - 1929 Standard Phaeton 35A**
- 1930 - 1931 Standard Phaeton 35B**
- June 1930 - 1931 Deluxe Phaeton 180A**
- 1929 - 1929 Standard Roadster 40A**
- 1930 - 1931 Standard Roadster 40B STD**
- August 1930 - 1931 Deluxe Roadster 40B DLX**

This is the car that "started it all". Our Henry, a RHD 1929 Phaeton bought by Mike in the mid 70's in Johannesburg, South Africa.

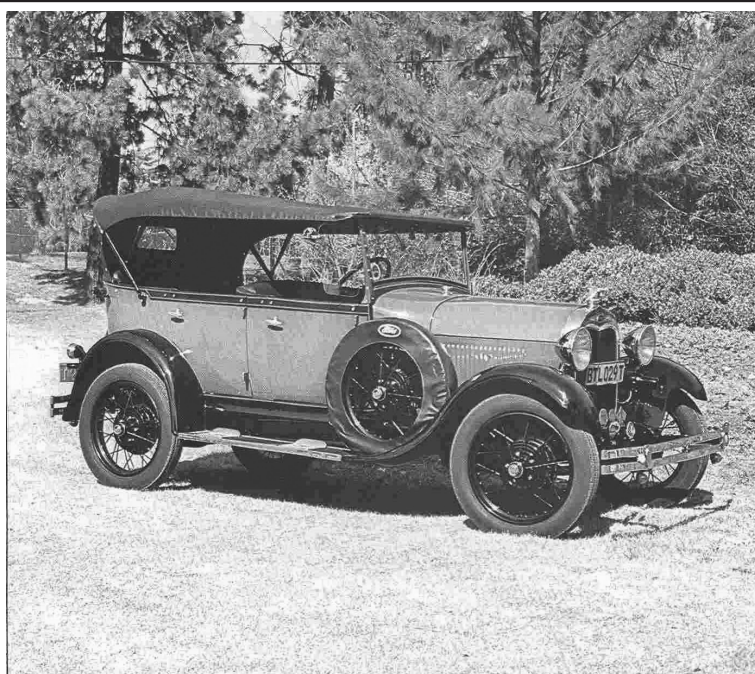

For Mike's Roadster - See Page Open 32.

OPEN CARS

Index	Page #	Index	Page #
Books & Accessories	Open 2	Sheet Metal	Open 6
Cowl Lights	Open 60	Sill Plates	Open 72
Dash Light	Open 71	Spare Tire Parts	Open 18
Door Handles & Parts	Open 42	Springs - Rear	Open 19
Fenders & Brackets - Rear	Open 18	- Seats	Open 75
Garnish Moldings & Frames	Open 72	Speedometer	Open 54
Gas Gauge	Open 52	Tail Lights	Open 64
Gas Tank	Open 47	- Drum	Open 68
Glass Sets & Pieces	Open 32	Top Parts	Open 37
Floorboard Parts	Open 46	Turn Signals	Open 70
Hood	Open 20	Upholstery	Open 75
Insulation	Open 45	Windshields & Parts	Open 29
Mirror	Open 58	Windshield Wipers	Open 33
Rumble & Trunk Parts	Open 25	Wood	Open 16
Seat Parts	Open 73		

Mike's "A" FORD-ABLE Parts

Books & Accessories

Judging Standards for Open Cars (Touring)

If you are building an Open car and want to make sure that you have everything correct for competition this is the book that you will need.

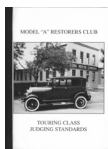

A91078 Price Ea. \$ 8.25

Restoring the Open "A"s

72 Page. Roadster and Phaetons 28-31. This book has a number of original pictures of Roadsters and Phaetons.



A91011 28-31 Price Ea. \$ 25.75

See "How to Restore your Model A - Vol. 6 (Page Gen. 75) for restoration information on a 1930 -31 Deluxe Roadster 40B.

Ford Color Prints

Beautiful prints of Made in America cars. Full color prints are from original paintings by Ford Motor Company illustrator Don Pacitti. You can order these prints with or without the Wood Grain finished frame with gold highlights. You can order these prints with or without the Wood Grain finished frame with gold highlights.



Prints ONLY - 11" x 14"

A91340A 28-29 Standard Roadster - 40A
 A91180 30-31 Deluxe Tudor Phaeton - 180A
 Price Ea. \$ 3.00

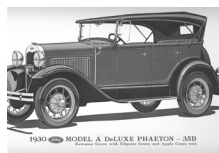

Prints ONLY - 12" x 18"

A91335A 1928 Phaeton - 35A
 A91335B 1930 Standard Phaeton - 35B with Deluxe features
 A91340B 1930 Deluxe Roadster - 40B with Windshield folded
 Price Ea. \$ 4.00

Framed Print - 11" x 14"

A91340AF 28-29 Standard Roadster - 40A
 A91180F 30-31 Deluxe Tudor Phaeton - 180A
 Price Ea. \$ 18.00

Frame Prints - 12" x 18"

A91335AF 1928 Phaeton - 35A
 A91335BF 1930 Standard Phaeton - 35B with Deluxe features
 A91340BF 1930 Deluxe Roadster - 40B with Windshield folded
 Price Ea. \$ 18.00

Windwing Glass

This glass is cut to the original specs and is beveled. Sold in pairs only. The design is etched onto the glass with silk screen fired ceramic.



A18252A 28-29 Open Car - 16" Tall Price Pair \$ 37.00
 A18252AD 28-29 Etched Price Pair \$ 54.75
 A18252B 30-31 Std. Roadster & Phaeton-14 1/2" Price Pair \$ 35.50
 A18252C 30-31 Dlx. Roadster & Phaeton - 13 " Price Pair \$ 33.75
 A18252CD 30-31 Etched Price Pair \$ 50.50

Windwing Pads

These are molded pads with the relief in the bracket like Ford used. They fit the original brackets but the raised portion can be shaved off to fit the reproduction brackets. New clamps include pads. Cut a piece of Inner Tubes for '30-'31.

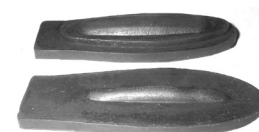

A18200APAD 28-29 Price Set/8 \$ 5.45

Windwing Bracket Tension Washer

This is a set of the four spring washers that go under the head of the locking bolt. Not included in Set. Used on Open Cars Only.



A18200W 28-31 Price Set/8 \$ 2.95

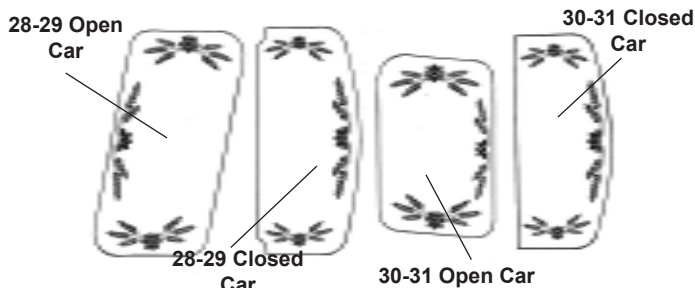

Open2 Give us a Call - 1-888-TRY-MIKE (879-6453) Have an "A" Day!

OPEN CARS

Mike's "A" FORD-ABLE Parts

'28-'29 Open Car Windwing Clamps

Full Instructions are included with each Kit.

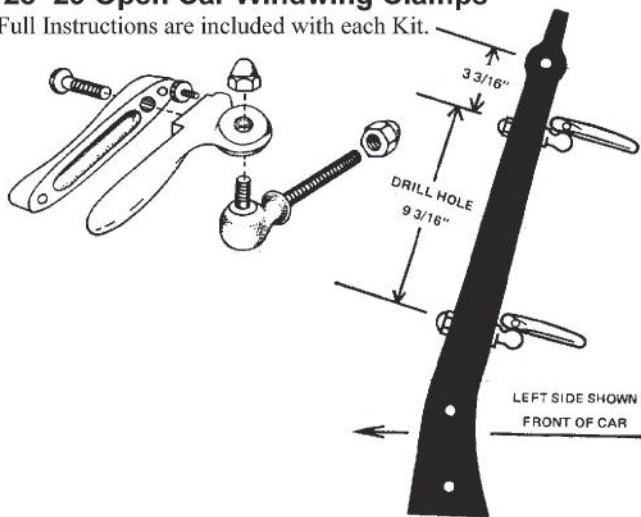

Windwing Clamps

These clamps are chrome plated for the windwing glass.



Trunks

This is a good quality, felt lined, trunk with all the hardware and leather straps. A locking key included.
13 x 34 x 20" High.



Tapered Backs are for **Phaetons** with a side mounted spare.

A18574SB	28-31	Black	Price Ea.	\$ 350.00
A18574ST	28-31	Tan	Price Ea.	\$ 350.00

The **Straight Back** trunk is made for the **Roadster**. Also for **Phaetons** with or without a Rear Spare.

A185740B	28-31	Black	Price Ea.	\$ 350.00
A185740T	28-31	Tan	Price Ea.	\$ 350.00

PLEASE NOTE: DUE TO THE SIZE AND WEIGHT OF THE TRUNKS THERE WILL BE AN ADDITIONAL SHIPPING CHARGE. PLEASE CALL FOR CURRENT PRICES. See Page Gen. 17 for Luggage Racks.

Trunk Straps

For mounting your trunk to the rack. 1" Wide by 72" Long. Nickel Plated Hardware. These are included with a new trunk. Need 2 per Trunk



A18574B	28-31	Black	Price Ea.	\$ 23.75
A18574T	28-31	Tan	Price Ea.	\$ 23.75

Trunk Boots

These will protect your trunk from the elements. It slips over the trunk and fastens with velcro. For trunks 12 3/4 d, 34 1/4 w, and 20" h.



A18575BSB	28-31	Straight backed Trunks - Black	Price Ea.	\$ 79.95
A18575TSB	28-31	Straight backed - Light Tan	Price Ea.	\$ 79.95
A18575BCB	28-31	Curved Back Sedan - Black	Price Ea.	\$ 79.95

Car Covers

For indoor storage only. Poly cotton material.



C14720PD	Roadster	Price Ea.	\$ 149.95
----------	----------	-----------	-----------

Roadster Key Fob

A wonderful gift idea. A silver plated brass key fob with a swivel feature that keeps the image always in view.



A18900	Roadster	Price Ea.	\$ 19.95
--------	----------	-----------	----------

Wallpaper Border

A wonderful finishing touch for your office or shop. Pre-pasted vinyl wall paper strips. 15' X 7".



A18825	Passenger Border	Price Roll	\$ 10.50
--------	------------------	------------	----------

"Model A Crossing" Sign

A Unique gift for the model A lover in your life. Would be great above a work bench or hanging up in the garage. These signs are yellow with black print. 19" x 19".



A18815	Roadster Sign	Price Ea.	\$ 16.00
--------	---------------	-----------	----------

Mike's "A" FORD-ABLE Parts

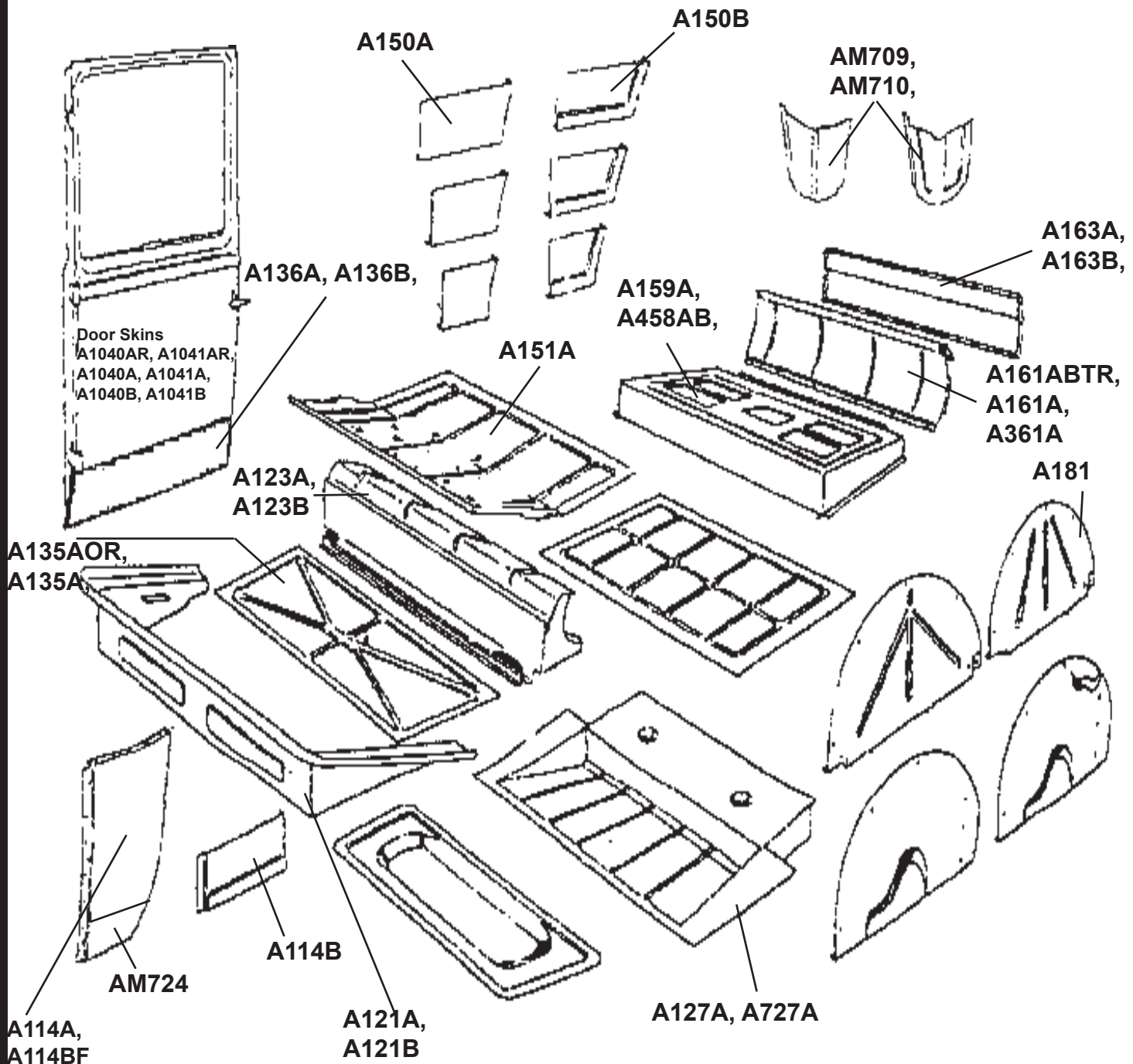

OPEN CARS

IMPORTANT!!!!

It is important when fitting sheet metal to your car to FIRST fit before painting or drilling any holes. Many times it is necessary to use C-Clamps, vise grips or a pin to locate holes for alignment.

In order to secure a proper fit and alignment, it is normally necessary to loosen all attaching sheet metal parts. Some reworking may be necessary as mating parts may come from different suppliers or new parts versus 50 year old parts are placed together.

Some metal parts may have been treated with oil or many still have residue from forming oils. It is necessary to thoroughly clean the metal with a metal prep or solution to remove all oils and/or fingerprints before painting.

NO REWORKED OR PAINTED PARTS ARE ACCEPTABLE FOR RETURN.

Mike's "A" FORD-ABLE Parts

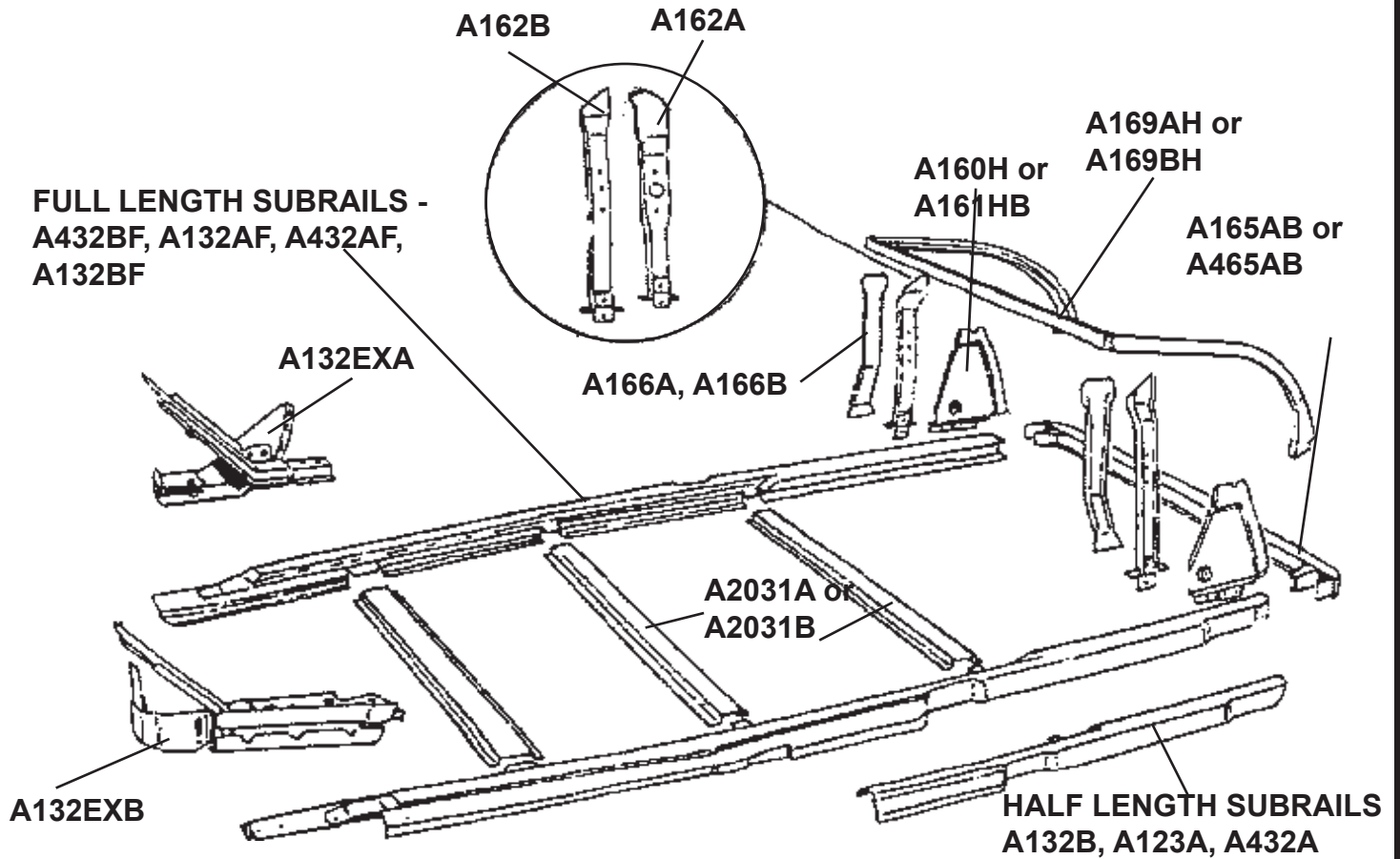

1928 - 1929 BODY PATCH PANELS

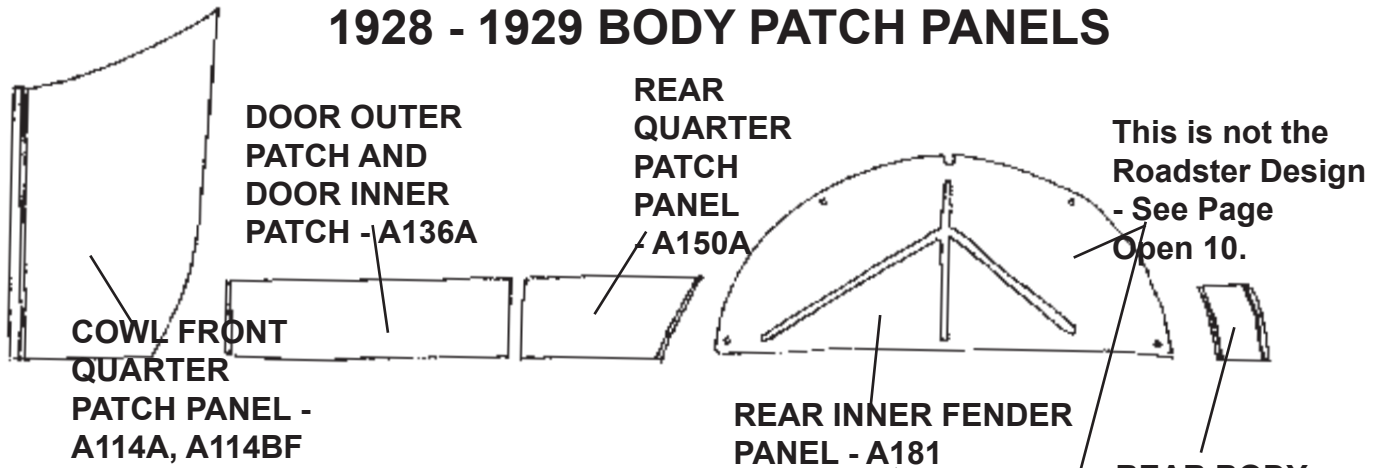

1930 - 1931 BODY PATCH PANELS

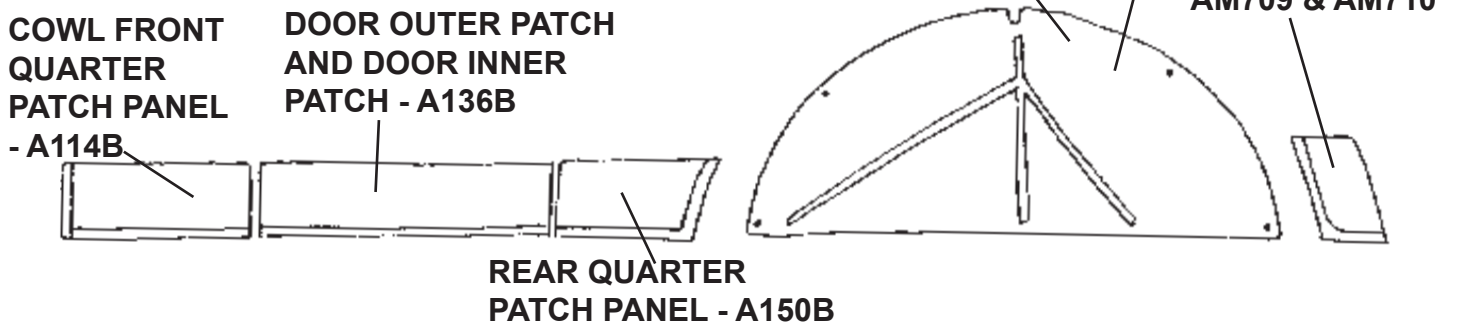

Mike's "A" FORD-ABLE Parts

Sheet Metal

PLEASE NOTE: Due to the size of certain pieces of sheet metal additional shipping charges may apply.

Deck Lids

Mike has excellent steel rear deck lids with the D-nuts already attached for your hinges. For Roadsters.

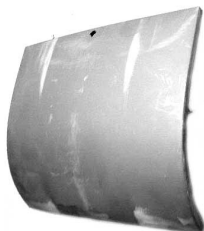

A1059AR	28-29	Steel - Rumble		
			Price Ea.	\$ 495.00
A1059BR	30-31	Steel - Rumble		
			Price Ea.	\$ 495.00



A1059AT	28-29	Steel - Trunk		
			Price Ea.	\$ 495.00
A1059BT	30-31	Steel - Trunk		
			Price Ea.	\$ 495.00

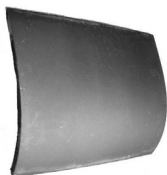

A1059ABS	28-31	Steel Rumble or Trunk Lid Skin		
			Price Ea.	\$ 200.00

Deck Lid Inner Panels

Mike now has this Inner Trunk or Rumble Panel available for your Roadster.



A1059A1S	28-29	Rumble	Price Ea.	\$ 276.00
A1059B1S	30-31	Rumble	Price Ea.	\$ 276.00
A1059A1T	28-29	Trunk	Price Ea.	\$ 276.00
A1059B1T	30-31	Trunk	Price Ea.	\$ 276.00

Rear Outer Panel Below Deck Lid

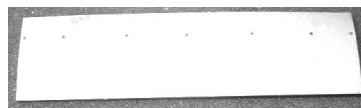

A163A	28-29	Roadster 9 1/2" High		
			Price Ea.	\$ 46.00



A163B	30-31	Roadster 9 1/4" High		
			Price Ea.	\$ 46.00

Rear Outer Panel Below Deck Lid Screws

8 x 12/24 x 5/8" Pan Head Screws and Lockwashers



A80163X	28-31		Price Set/16	\$ 1.60
---------	-------	--	--------------	---------

Rear Outer Panel Above Deck Lid



37 1/4" x 11 1/2"				
A167B	30-31	Roadster	Price Ea.	\$ 161.00

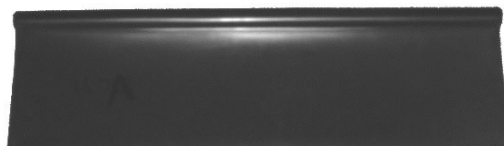

37" x 10"				
A167A	28-29	Roadster	Price Ea.	\$ 161.00

Rumble Seat Compartment Curved Inner Panel

When converting from a trunk to a Rumble Seat, this panel is needed. The top of this panel, mounts to the panel below deck lid, with a maximum height of 14 1/4" and the bottom sits on top of the rumble platform on '28-'31 Roadster.

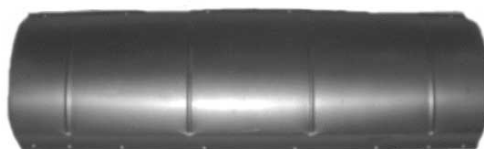

A161A	28-31		Price Ea.	\$ 40.00
-------	-------	--	-----------	----------

OPEN CARS

Open6

Give us a Call - 1-888-TRY-MIKE (879-6453) Have an "A" Day!

Mike's "A" FORD-ABLE Parts

Curved Inner Panel Screws

6 x 10/32 x 5/8" Oval for Top Edge.

8 x 1/4-20 x 1/2" Oval with Lock Washers and Square Nuts for the bottom.



A80161X 28-31 Price Set/30 \$ 1.90

Trunk Seat Compartment Curved Inner Panel

When you are converting from a Rumble to a Trunk on a '28-'31 Roadster, this panel is used by all Model A's using the Rumble as a trunk. All Required brackets are supplied.



A161ABTR 28-31 Price Ea. \$ 69.00

Spare Tire Brace

This brace supports the inside of the outer panel for the spare tire bracket. Can be used on '28-'29 panels, but must be shortened to fit.



A163ABR 28-31 Price Ea. \$ 21.00

Triangle Support Bracket

These attach to the curved inner panel. 9 3/8" High x 9 1/2" Long.

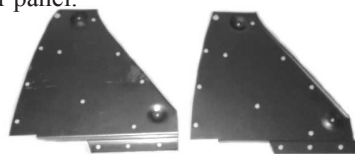

A160H 28-31 Roadster Price Pair \$ 59.95



Some Roadsters came out with this style.

A161HB Price Pair \$ 59.95

Front Raingutter Support Bracket to Fenderwell Support or Compartment Braces.

For Trunk or Rumble - 3/12" Wide at top, 23" Long, and 2" Wide in the Middle.

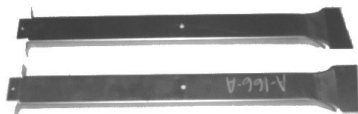

A166A 28- May 1931 Roadster Price Pair \$ 51.00

Front Raingutter Support Bracket to Fenderwell Support or Compartment Braces.

For Trunk or Rumble - 3 1/4" Wide at top, 17 1/2" Long, and 2" Wide in the Middle.



A166B Late '31 Roadster Price Pair \$ 51.00

Rumble Hinge Brace

Your rumble Hinge Mounting Bracket bolts to these Braces. 2 1/4" High and 18" Long.



A162A 28-29 Roadster Price Pair \$ 51.00
A162B 30-31 Roadster Price Pair \$ 51.00

Roadster Trunk or Rumble Seat Platform

Use this panel even when installing a trunk.

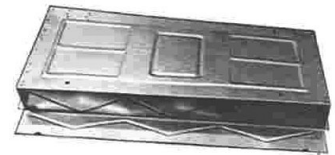

A159A 28-31 Original Design Price Ea. \$ 69.00

Trunk or Rumble Floor Pans

This is the piece that you would put your feet onto. Angled Style used with Seat Riser.

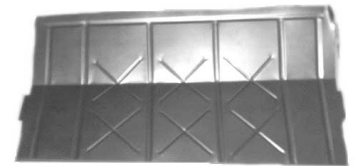

A151A 28-31 Roadster Price Ea. \$ 57.00

Mike's "A" FORD-ABLE Parts

Rain Gutter Assembly

Used for Rumble or Trunk - You will have to weld together.
Made in Sections for shipping purposes.



- | | | | | |
|--------|-------|----------|-----------|-----------|
| A169AH | 28-29 | Roadster | | |
| | | | Price Set | \$ 190.00 |
| A169BH | 30-31 | Roadster | | |
| | | | Price Set | \$ 190.00 |



- | | | | | |
|---------|-------|--|------------|----------|
| A169ATH | 28-29 | Upper Rain Gutter Trough - that goes from side to side | Price Ea. | \$ 81.00 |
| A169ASH | 28-31 | Sides of Rain Gutter | Price Pair | \$ 98.00 |

- | | | | | |
|--------|-------|--|--|----------|
| A41517 | 28-31 | Triangle Corners (This fits in each corner of rain gutter).
2 Needed. Price Ea. | | \$ 12.75 |
|--------|-------|--|--|----------|



- | | | | | |
|---------|-------|---|-----------|----------|
| A169BTH | 30-31 | Upper Rain Gutter Trough (That goes from side to side). | Price Ea. | \$ 81.00 |
|---------|-------|---|-----------|----------|

Front Seat Back Rest Riser

Back rest spring sits on this part.



- | | | | | |
|-------|-------|----------|-----------|----------|
| A123A | 28-29 | Roadster | Price Ea. | \$ 63.00 |
|-------|-------|----------|-----------|----------|



- | | | | | |
|-------|-------|----------|-----------|----------|
| A123B | 30-31 | Roadster | Price Ea. | \$ 80.00 |
|-------|-------|----------|-----------|----------|

Front Seat Riser

Mike also has these steel risers available which fit between the seat springs and the floor.



- | | | | | |
|-------|-------|----------------------|-----------|----------|
| A121A | 28-29 | Roadster and Phaeton | Price Ea. | \$ 63.00 |
|-------|-------|----------------------|-----------|----------|



- | | | | | |
|-------|-------|----------------------|-----------|----------|
| A121B | 30-31 | Roadster and Phaeton | Price Ea. | \$ 67.00 |
|-------|-------|----------------------|-----------|----------|

Rear Seat Frame

Seat spring sits on this part. Includes hump. Spot weld to rear floor.

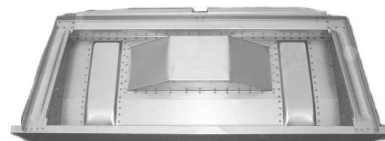

- | | | | | |
|---------|-------|----------------------|-----------|-----------|
| A757AWH | 28-29 | Phaeton - with Hump. | Price Ea. | \$ 250.00 |
|---------|-------|----------------------|-----------|-----------|

With floor pan, spot weld to rear floor - No Hump.



- | | | | | |
|-------|-------|---------|-----------|-----------|
| A757A | 28-29 | Phaeton | Price Ea. | \$ 212.50 |
|-------|-------|---------|-----------|-----------|

Rear Floor Pan Spring Hump

Hump - 8 1/2" x 22".



- | | | | | |
|--------|-------|----------|-----------|----------|
| A458AB | 28-29 | Phaetons | Price Ea. | \$ 37.50 |
|--------|-------|----------|-----------|----------|

OPEN CARS

Mike's "A" FORD-ABLE Parts

Curtain Pans (Panel under Seat)

Fits under Front Seat Riser. This is the Panel Under the Front Seat, but **A135A** or **A335B** can be used for **Roadsters** and **Phaetons**, if you do not want curtain pans.

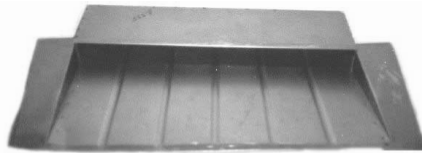

A127A 29-31 **Roadster and Phaetons**
 Price Ea. \$ 67.00

Under rear floorboards.
1 3/4" High x 32 1/2" long
x 23 1/2" wide with a
3/4" lip.

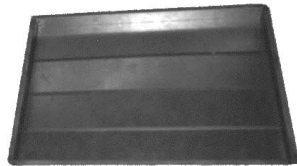

A727A **Early 28 Std. Phaeton** Price Ea. \$ 65.00

Panel Under Seat Frame

This goes under the Seat Riser and serves as a Floor Pan.

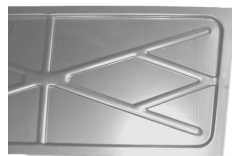

A135A 28-31 **Roadster & Phaetons**
 Price Ea. \$ 49.00

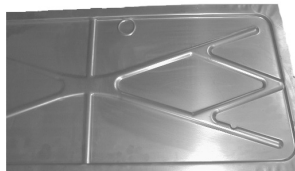

A135AOR This is the same as the **A135A** above, but die stamped to the original design
 Price Ea. \$ 55.20

Cowl Quarter Patch Panels



A114A 28-29 **Complete panel**
 Price Pair \$ 114.00



AM724 28-29 **Bottom 6" Panel**
 Price Pair \$ 43.00



13 1/2" x 6" High
A114B 30-31 **Roadster & Phaeton**
 Price Pair \$ 26.95

Complete panel.
22 3/4" x 25 1/4" x 16 1/4".



A114BF 30-31 **Open Cars**
 Price Pair \$ 285.00

Contoured Cowl Patch

A new correctly contoured patch has the compound curves of the cowl and also the correct beading. Available only for '30-'31.



A014BD 30-31 Price Pair \$ 53.50

OPEN CARS

Mike's "A" FORD-ABLE Parts

Door Bottom Outer Patch Panels

22 1/4" x 6" High
A136A



28-29 Roadster
Price Pair \$ 50.00

23 1/2" x 6" High
A136B



30-31 Roadster
Price Pair. \$ 60.00

4 Pieces
A826



28-29 Phaeton
Price Set \$ 55.20

4 Pieces
A827



30-31 Phaeton
Price Set \$ 55.20

Rear Quarter Patch Panels

A150A



28-29 Roadster - Straight Edge
23 1/2" x 6 1/2"
Price Pair \$ 46.00

A150B



30-31 Roadster - Beaded Edge -
19 1/2" x 6 1/2"
Price Pair \$ 46.00

Rear Inner Fender Panels

Original style.

A181

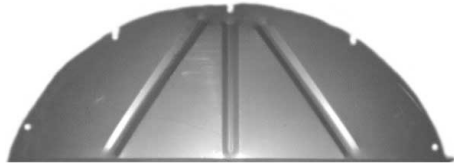

28-31 Roadster -
14" High at Ctr x 33 1/2" Long
Price Pair \$ 54.50

AM503

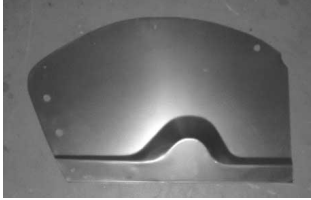

28-29 Fordor Phaeton, Original Style
15 1/4" High at Ctr x 24" at
widest Point tapering to 19 1/4"
at base
Price Pair \$ 54.50

AM504

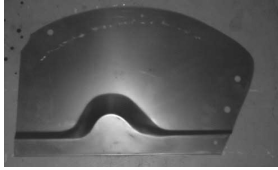

30-31 Fordor Phaeton, Original Style
15 1/4" High at Ctr x 24" at
widest Point tapering to 19 1/4"
at base
Price Pair \$ 54.50

Rear Corner Patch Panels

Be Prepared to do some altering to fit -
Sorry, but these are the best available.

5 - 6" Tall
AM709



28-29 Roadster
Price Pair \$ 36.75

AM710

30-31 Roadster
Price Pair \$ 36.75

AM712



30-31 Fordor Phaeton
Price Pair \$ 36.75

OPEN CARS

Mike's "A" FORD-ABLE Parts

Subrails

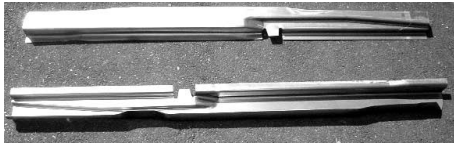

Rear half, from door back.

A132A **28-29** **Roadster**

Price Set **\$ 150.00**



Rear half, from door back.

A132B **30-31** **Roadster**

Price Set **\$ 150.00**



Rear half, from door back

A432A **28-29** **Phaeton**

Price Set **\$ 150.00**



Full length.

A132AF **28-29** **Roadster**

Price Set **\$ 270.00**



Full length.

A132BF **30-31** **Roadster**

Price Set **\$ 270.00**

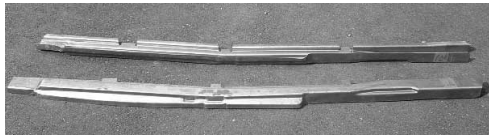

Full length.

A432AF **28-29** **Phaeton**

Price Set **\$ 270.00**



Full length.

A432BF **30-31** **Phaeton**

Price Set **\$ 270.00**

Subrail Extension - Floor Board Braces

Used on the Front of the Subrails for the Floorboards to mount onto. 4 Pieces.



A132EXB

30-31 **Roadster & Phaeton**

Price Set/4 **\$ 220.00**

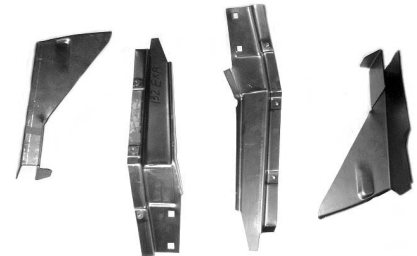

A132EXA

28-29 **Roadster & Phaeton**

Price Set/4 **\$ 170.00**

Rear Sub Frame Channel (Rear Cross Member)

Fits below outer panel that ties the Sub Rails together at the back of the car. Includes D-Nuts to mount the Outer Panel and the Spare Tire.



A165AB **28-31** **Roadster**

Price Ea. **\$ 158.00**

A465AB **28-31** **Phaeton**

Price Ea. **\$ 158.00**

Complete Sub Frame Assembly - Roadster

Includes: Subrail, Cross channel and Panel under seat frame, seat riser, rumble floor, rumble platform - all primed and riveted together. (Large piece, shipped by truck only.)



A2032AASSEM

28-29

Roadster

Price Kit **\$ 560.00**

A2032BASSEM

30-31

Roadster

Price Kit **\$ 560.00**

Mike's "A" FORD-ABLE Parts

Cross Channels

These cross-rails connect the subrails to give a good foundation for the floor pan and floorboards on the Roadster.

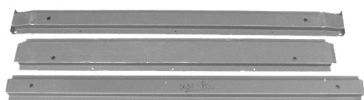

A2031A 28-29 3 Pieces Price Set \$ 98.00

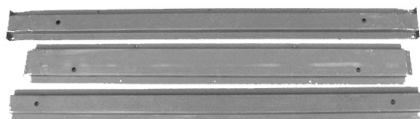

A2031B 30-31 3 Pieces Price Set \$ 98.00

Package Tray & Seat Adjuster

This is the steel frame, that holds the rear section of the package tray in place.

2 Pieces.



A125B/129B Combo both Package Tray & Seat Adjuster Price Set \$ 95.00

A129B 30-31 Roadster Package Tray Price Ea. \$ 58.00

A125B 30-31 Roadster Seat Adjuster - Bolts to the Package Tray. Price Ea. \$ 40.00

Rear Center Body Panels

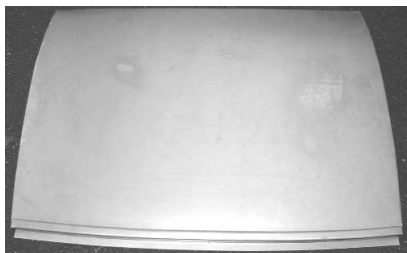

A299H 28-29 Phaeton Price Ea. \$ 120.00



A298H 30-31 Phaeton Price Ea. \$ 120.00

Back of Front Seat Panel

Sitting at the back, you would be facing this piece.



A415H 28-29 Phaeton Price Ea. \$ 240.00

A416H 30-31 Phaeton Price Ea. \$ 240.00

Toe Panel

This panel goes under the back of the front seat of Standard Phaetons. If you are sitting in the back seat, your toes would bump against this panel.



A123AP 28-29 Phaeton Price Ea. \$ 95.00

A123BP 30-31 Phaeton Price Ea. \$ 95.00

Open Car Dash Reinforcement Bars

The Steel support Bar that runs between the cowl posts under the dash rail. Ties the cowl Posts Together.



A1005A 28-29 Price Ea. \$ 99.00



A1005B 30-31 Price Ea. \$ 99.00

Roadster & Phaeton Dash Rail.

Die stamped steel



A195A 28-29 Price Ea. \$ 195.00



A1001B 30-31 Price Ea. \$ 240.00

OPEN CARS

Mike's "A" FORD-ABLE Parts

Roadster & Phaeton Dash Rail Bracket

Open Cars will need to have this Bracket mounted to the Left and Right side of the Dash Bar to Support The Dash Rail.



A1001AB 28-29 Price Pair \$ 45.00



A1013B 30-31 Price Pair \$ 205.00

Dash Rail Center Brace

This is the Center Brace that goes on the Reinforcement Bar that the Dash Rail fastens to.



RAR219 28-29 Price Pair \$ 8.95

Roadster & Phaeton Cowl Post

Includes Cowl Post Brace A1010AB - below.
Used on 28-29 Roadster & Phaeton.



A1010A 28-29 Left Price Ea. \$ 199.00



A1011A 28-29 Right Price Ea. \$ 199.00

Roadster & Phaeton Cowl Post Patch

This is the 6 1/2" Piece at the bottom of A1010A and A1011A.

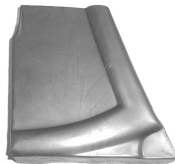

A1010P 28 - 29 Left Price Ea. \$ 37.50
A1011P 28 - 29 Right Price Ea. \$ 37.50

Roadster & Phaeton Cowl Post Lower Brace

6" High x 4 3/4" x 4 7/8".



A1010AB 28-29 Price Pair \$ 39.00

Roadster & Phaeton Cowl Panel Brace

These are needed when installing cowl lights.



A13300BB 30-31 Upper Price Pair \$ 46.00

Open Car Only
A1010BLB



30-31 Lower Price Pair \$ 68.25

Open Car Only
A1010BFB



30-31 Front Brace
Price Pair \$ 99.25

Firewall - Original

Lower. Paint Lower Body Color

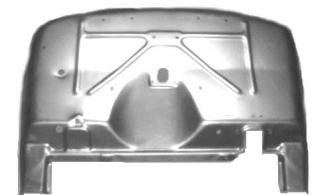

A1015 28-29 Price Ea. \$ 210.00
A1015B 30-31 Price Ea. \$ 259.00

Recessed Firewall - Street Rods

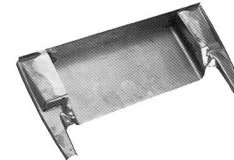

A1015AREC4 28-29 4" Price Ea. \$ 259.00
A1015AREC5 28-29 5" Price Ea. \$ 259.00
A1015BREC4 30-31 4" Price Ea. \$ 330.00
A1015BREC5 30-31 5" Price Ea. \$ 365.00

Cowl Top Panels - Street Rods

Panel that replaces the Model A Gas Tank, filled style with no hole for the gas filler neck.



A117A 28-29 Price Ea. \$ 290.00



A117B 30-31 Price Ea. \$ 290.00

Mike's "A" FORD-ABLE Parts

Hot Rod Upper Firewall

Replaces the Standard Model "A" Type.

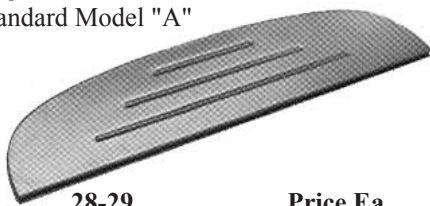

AF118F 28-29 Price Ea. \$ 90.00

Open Car Braces For Quarter Panel

4 parts.



Left			
A2050ABR	28-29	Roadster	Price Ea. \$ 126.50
A2050BBR	30-31	Roadster	Price Ea. \$ 126.50
Right			
A2051ABR	28-29	Roadster	Price Ea. \$ 126.00
A2051BBR	30-31	Roadster	Price Ea. \$ 126.00

Roadster Complete Quarter Panel

These are delivered by Freight Line Only. Comes with quarter panels installed.



A2050A	28-29	Roadster with Braces - Left	Price Ea. \$ 799.25
A2050AWO	28-29	Roadster without Braces - Left	Price Ea. \$ 688.85
A2051A	28-29	Roadster with Braces - Right	Price Ea. \$ 795.00
A2051AWO	28-29	Roadster without Braces - Right	Price Ea. \$ 699.00
A2050B	30-31	Roadster with Braces - Left	Price Ea. \$ 795.00
A2050BWO	30-31	Roadster without Braces - Left	Price Ea. \$ 699.00
A2051B	30-31	Roadster with Braces - Right	Price Ea. \$ 795.00
A2051BWO	30-31	Roadster without Braces - Right	Price Ea. \$ 699.00

Roadster "T" Strip

Roadsters will need this aluminum molding from the back of the quarter panel up to the top tack rail. Straight Length or Preformed available.



A2050AEXTC 28-29 Preformed Price Pair \$ 69.00

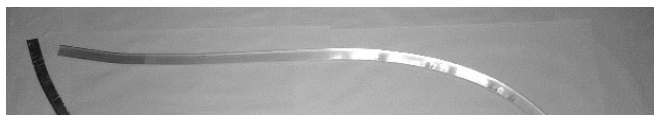

A2050AEXT 28-29 Straight - 1/4" Panel Extrusion Price Pair \$ 50.00

Door Skins - Open Cars

If your inner door frame is in good shape, you may want to replace only the outer skin. Available for Roadster, and Phaeton.

Front Door Only. Be aware that the '28 did not have an outside door handle and order accordingly.



A1040AR	1928	Left	
A1041AR	1928	Right	
A1040A	1929	Left	
A1041A	1929	Right	
A1040B	30-31	Left	
A1041B	30-31	Right	Price Ea. \$ 175.00

Doors - Open Cars

These are very good reproduction steel doors for the Roadster and standard Phaeton - front doors with hinges included. Be aware that the '28 did not have an outside door handle. Order accordingly. **For Open Car Hinges - See Page Open 42.**



A1046AR	1928	Left	
A1047AR	1928	Right	
A1046A	1929	Left	
A1047A	1929	Right	
A1046B	30-31	Left	
A1047B	30-31	Right	Price Ea. \$ 515.00

OPEN CARS

Mike's "A" FORD-ABLE Parts



1929 Roadster owned and restored by Mr. S. Cole - notice the original accessory hub caps. Steve is one of our Technical Guru's here at Mike's.

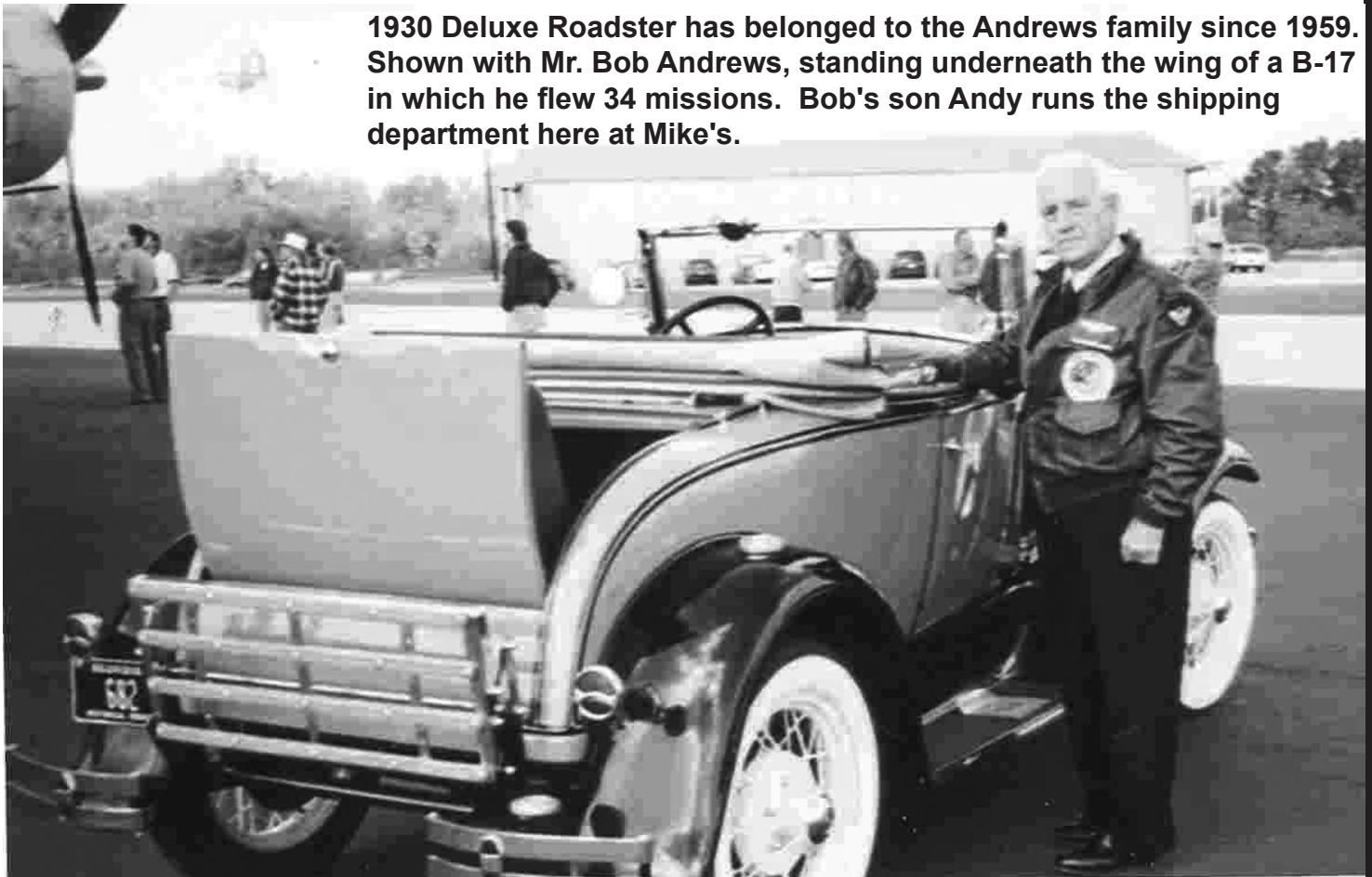

1930 Deluxe Roadster has belonged to the Andrews family since 1959. Shown with Mr. Bob Andrews, standing underneath the wing of a B-17 in which he flew 34 missions. Bob's son Andy runs the shipping department here at Mike's.

Mike's "A" FORD-ABLE Parts

Wood

Welcome to Mike's Wood Section. We have a complete selection of wood available for all Roadsters & Phaetons, made out of the finest wood available. Each Piece is custom made to fit exactly like it was originally made using top quality hardwoods - oak, ash or poplar. We do not stock these items, they will be shipped directly from the manufacturer - separate shipping charges will apply.

UNFORTUNATELY DUE TO THE AMOUNT OF RETURNS INDIVIDUAL WOOD PIECES ARE NO LONGER AVAILABLE.

***** MIKE'S TIPS *****

If you are having a problem with your Doors, or your Hood will not line up with your Radiator Shell and Cowl - additional Shimming is required, usually under the cowl section. Align the hood first, then work back.

Top Wood - All of the wood from the top of the doors up.

Ribs - These go across the roof and support the top.

Belt Rail - Around the edge of the body where the top meets the body.

Body Wood - Structural Wood inside the body - Does NOT include Chassis wood, Belt Rail or Door wood, unless specified.

Headers - Wood above the windshield - Always included in the Top Wood Kits.

Roadster & Phaeton Body Mount Blocks

If your car has wooden sub rails, you don't need these! They go between the steel sub rails and the frame. Complete set per car. Don't forget to order your body block pads A5000P, A5001P and/or Cowl Shims A5002P.



Instructions are included.

AWD1005 28-29 Price Set \$ 29.50

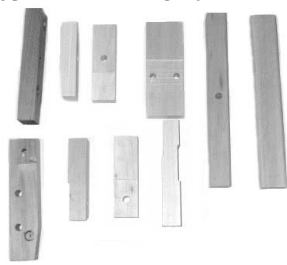

AWD1016 30-31 Price Set \$ 29.50

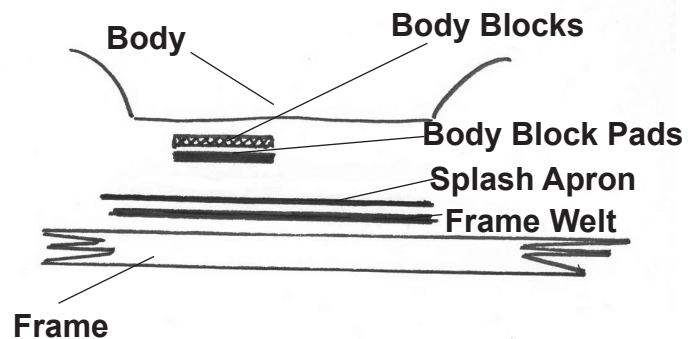

Body to Frame Mounting Bolt Sets

Body to frame bolts were different for each year and body style car. These complete kits come with complete instructions.



A90406	28-29	Roadster	Price Set/48	\$ 9.95
A90407	30-31	Roadster	Price Set/54	\$ 9.00
A90412	28-29	Phaeton	Price Set/48	\$ 9.95
A90413	30-31	Phaeton	Price Set/48	\$ 9.95

Roadster Header

AWD-RD-1	30-31	Deluxe Roadster 40B	Price Ea.	\$ 52.00
----------	-------	---------------------	-----------	----------

OPEN CARS

Mike's "A" FORD-ABLE Parts

Roadster Top Wood Kits

Includes Header. Everything above the door opening.

A42056-AOR	28-29	Roadster - fits original top sockets Only	
		Price Kit	\$ 86.00

Roadster & Phaeton Body Wood Kits

Body Shell wood less Top, Chassis & Door Wood.

AWD1276	28-29	Roadster 40A	
		Price Kit	\$ 135.00
AWD1277	28-29	Phaeton 35A	
		Price Kit	\$ 250.00
AWD1278	30-31	Roadster 40B	
		Price Kit	\$ 134.00
AWD1290	30-31	Phaeton 35B	
		Price Kit	\$ 250.00
AWD1289	30-31	2 Door Deluxe Phaeton 180A	
		Price Kit	\$ 530.00

Phaeton Chassis Wood Kit

Sills & Crossmembers

AWD1389	30-31	Two Door Deluxe Phaeton 180A	
		Price Kit	\$ 662.00

Phaeton Door Wood Kit

AWD 1289-4	30-31	Two Door Deluxe Phaeton 180A	
		Price Kit	\$ 565.00

Roadster & Phaeton Belt Rails and Tack Rails

These Belt and Tack Rails are included in the Body Wood Kits.

AWD1276-2	28-29	Roadster 40A - 3 Pieces	
		Price Kit	\$ 52.00
AWD1277-2F	28-29	Phaeton 35A Front Seat - 3 Pieces	
		Price Kit	\$ 44.50
AWD1277-2R	28-29	Phaeton 35A Rear Seat - 3 Pieces	
		Price Kit	\$ 44.50
AWD1278-2	30-31	Roadster 40B - 3 Pieces	
		Price Kit	\$ 44.00
AWD1289-2	30-31	Two Door Deluxe Phaeton 180A	
		Price Kit	\$ 330.00
AWD1290-2F	30-31	Standard Phaeton 35B Front Seat Ends - 2 Pieces	
		Price Kit	\$ 9.25
AWD1290-2R	30-31	Standard Phaeton 35B Rear Seat 3 Pieces	
		Price Kit	\$ 51.50

Roadster Seat Frame Wood Kits

AWD1523	28-29	Roadster 40A Seat Back - 6 Pieces - included in body wood kits	
		Price Set	\$ 32.50
AWD1525	30-31	Roadster 40B Seat Back - 5 Pieces - included in body wood kits	
		Price Set	\$ 38.00

Body Nails

Commonly used on all Model "A's"



Nail Style #3

.074 diam. x 3/4" long - oval head - pack of 100

Price Pack \$ 1.50

Nail Style #4

Top Mouldings & Rain Gutter - .085 x 7/8" long - pack of 100

Price Pack \$ 1.50

Nail Style #5

Use these where rusting could occur - Stainless Steel .085x 3/4" long - pack 100

Price Pack \$ 3.00

Roof Tacks

This is a set of 100 zinc plated tacks used to tack the black vinyl decking to the wood top frame. The top molding covers these tacks.



A38425MBR	28-31		
		Price Pack	\$ 2.25

Mike's "A" FORD-ABLE Parts

Spare Tire

Only Roadster & Phaeton specific items are listed here, for more Spare Tire related items and accessories see page Gen. 39.

Rear Spare Tire Carrier

Carrier for the Roadster & Phaeton.
Cast aluminum. Studs included.
Paint black.



A1379AR	28-29	Roadster	Price Ea.	\$ 55.00
A1379B	30-31	Roadster	Price Ea.	\$ 55.00
A1380AR	28-31	Phaeton	Price Ea.	\$ 55.00

Rear spare Wheel Mount to Body Bolts

The bolts for the Rear Spare Tire Carrier above.



A1379AMB	28-31	Roadster	Price Ea.	\$ 2.10
----------	-------	----------	-----------	---------



A1379BMB	28-31	Phaeton	Price Ea.	\$ 2.10
----------	-------	---------	-----------	---------

Spare Tire Support

Used on the rumble seat of the Roadster with a rear mounted spare tire.
Contoured to follow the curved inner panel. The top bolt on the carrier goes through the hole at the bottom.



A1401	30-31		Price Ea.	\$ 7.10
-------	-------	--	-----------	---------

Spare Tire Brace

This brace supports the inside of the outer panel for the spare tire bracket. Can be used on '28-'29 panels, but must be shortened to fit.



A163ABR	28-31		Price Ea.	\$ 21.00
---------	-------	--	-----------	----------

Rear Spare Wheel Tire Stud

Used on the Roadster, bottom stud only, the top two are the A1448 (Side Spare Wheel Tire Carrier Bolt) see page Gen. 39.



A1449	28-31		Price Ea.	\$ 1.65
-------	-------	--	-----------	---------

Rear Fenders & Brackets

As front fenders are generic to all Model A's they are still in there own Section - See Page Gen. 199 & 200 For Front Fenders

Roadster & Phaeton Rear Fenders

Please read carefully before purchase.

Fiberglass Fenders - A complete line of fiberglass fenders are available. These are all hand laminated with fiberglass matte and special resins to achieve the optimum in strength.

Please Note: Additional shipping will apply due to large boxes. These are special orders, please allow three to four weeks for delivery. Rear fenders will be shipped by courier and are charged according to the box size.

Steel Fenders - It is important when fitting sheet metal to your car to FIRST fit before painting or drilling any holes. Many times it is necessary to use C-Clamps, vise grips or a drift pin to locate holes for alignment. In order to secure a proper fit and alignment, it is normally necessary to loosen all attaching sheet metal parts. Some reworking may be necessary as mating parts many come from different suppliers or new parts versus 80 year old parts are placed together. Some metal parts may have been treated with oil or may still have residue from forming oils. It is necessary to thoroughly clean the metal with a metal prep or solution to remove all oils and / or fingerprints before painting.

NO RE-WORKED, RUSTED OR PAINTED FENDERS ARE ACCEPTABLE FOR RETURN.

Roadster Rear Fiberglass Fenders:

1928 - 1929

F16161A	Left	Price Ea.	\$ 199.00
F16160A	Right	Price Ea.	\$ 199.00

1930 - Early 1931

F16161B	Left	Price Ea.	\$ 199.00
F16160B	Right	Price Ea.	\$ 199.00

Phaeton Rear Fiberglass Fenders

1928-1929

F16311A	Left	Price Ea.	\$ 199.00
F16310A	Right	Price Ea.	\$ 199.00

1930-1931

F16311B	Left	Price Ea.	\$ 199.00
F16310B	Right	Price Ea.	\$ 199.00

OPEN CARS

Mike's "A" FORD-ABLE Parts

Rear Steel Fenders:

These are very well-made reproductions using the same gauge steel as Ford used.

Please read the instructions on Page Open 18.
SOLD IN PAIRS ONLY.



Roadster				
A16160/61A	28-29	Left & Right	Price Pair	\$ 520.00
A16160/61B	30-31	Left & Right	Price Pair	\$ 520.00
Phaeton				
A16160/61C	30-31	Left & Right	Price Pair	\$ 620.00
A16160/61D	28-29	Left & Right	Price Pair	\$ 620.00

Rear Fender Bracket

Here are the pressed steel rear fender brackets for the **Roadster**.



A16180A	28-31	Price Ea.	\$ 24.70
---------	-------	-----------	----------

Rear Fender Bracket

Here are the pressed steel rear fender brackets for the **Phaeton**.



A16180C	28-31	Price Ea.	\$ 24.70
---------	-------	-----------	----------

Rear Fender Bracket

These rear fender Brackets are for the '30-'31 2 Door Deluxe Phaeton Only.



A16180PH	1931	Price Ea.	\$ 24.70
----------	------	-----------	----------

Rear Fender Bracket Bolts

This set of bolts and castle nuts will attach both rear fender brackets to the body.



A16181MB	29-31	6 5/16" - 24 x 1" + Lw & nuts	Price Set/10	\$ 2.50
----------	-------	-------------------------------	--------------	---------

Rear Fender Washers & Nuts

If your studs (A081MB) are OK, then this set of 8 Flat Washers, Lockwashers and 5/16-18 Nuts are used to mount rear fenders to body.



A16195	29-31	Price Set/24	\$ 1.50
--------	-------	--------------	---------

Rear Fender Mount Studs

These are the special oversized head bolts that get welded or brazed to the body to mount the rear fenders on.



A081MB	28-31	4 studs needed per fender	Price Ea.	\$ 0.50
--------	-------	---------------------------	-----------	---------

Fender Welt

Mike has this 17 foot roll of the 3/16" black beading used on the fenders.



A3404FW	28-31	Price Ea.	\$ 9.00
---------	-------	-----------	---------

Rear Bumper Brackets

These brackets extend from the frame to mount the rear bumper. The stands come attached. This bracket is bolted UNDER the top of the frame, approx. 6" in front of the rear crossmember.



A17777A	28-31 Phaetons	3 1/4" stands	Price Pair	\$ 125.00
A17777C	28-31 Roadsters	5 1/4" stands	Price Pair	\$ 125.00

Rear Bumper Bracket-Body Stand

You will need two of these brackets which support the bumper brackets toward the rear of the car.



A17830C	28-31 Roadster	- 5 1/4"	Price Ea.	\$ 11.50
A17830A	28-31 Phaetons	- 3 1/4"	Price Ea.	\$ 11.50

Rear Bumper Bracket to Stand Rivets

If you need to replace the stands here are the rivets that you will need.



RA1005	Price Ea.	\$ 0.80
--------	-----------	---------

Rear Spring

For more spring related items see page Gen. 98 in the general section.

Roadster & Phaeton Rear Leaf Spring

A good reproduction of the original.
Clamps NOT included.
For Clamps, bushings, Bolts and Nuts See Page Gen. 98.



A5560B	8 Leaf	28-31 Phaeton	Price Ea.	\$ 230.00
A5560C	7 Leaf	28-31 Roadster	Price Ea.	\$ 220.00

Mike's "A" FORD-ABLE Parts

Hood

Hood Handle

These are pressed steel handles which mount in the middle of the side panels to lift the hood.

Rivets Included.

Use Rivet Tool RA2022 on Page Gen. 28.

A16609 28-31 Price Pair \$ 24.95

Comes with A16755 Modern Rivet Style

A16609SS 28-31 Stainless Price Pair \$ 30.75



Hood Latch Brackets

This is a complete set of brackets and hardware that the hood latch hooks onto. Use rivets A16753.

If you are using rivets, use Rivet Tool RA2022 on Page Gen. 28.

A16750CL 28-31 Price Set/16 \$ 4.95

Comes with A16753 Original Rivets, or you can order A16755 Modern Style separately.

A16750HCSS 28-31 Stainless Price Set/16 \$ 12.05



Hood Handle & Latch Clip Rivet Set

Original style rivets for the hood handles and clip brackets. Use RA2022 Rivet Tool on Page Gen. 28.

A16753 Price Set/20 \$ 2.00



Modern Style Hood Handle & Latch Clip Screw Set

These screws are used on the Hood Handles and Hood Clips - not original.

These are stainless round head screws with nuts that look like rivets from the outside. No riveting needed!!

A16755 Price Set/20 \$ 4.95



Hood Prop Kit

These stainless steel props are an important add-on for safety. The kit bolts onto the radiator braces and the fold out arms are rubber-coated to rest the hood on.

A16613SS 28-31 Price Kit \$ 24.95



Hood Safety Supports

Mounts on the hood rods, and hooks to hood rod bracket on firewall. When you raise the hood, set the bottom edge of the hood on the hooked end of the arm - protective plastic covers the wire. Set includes left and right side wire. Instructions included.

A16714A 28-29 Price Set \$ 21.95

A16714B 30-31 Price Set \$ 21.95



Early '28 Hood (All Early '28 Cars)

The early '28 hood louvres were all the same length. From mid '28 the top of the louvres on the side had a slight taper. Trophy Quality. Paint Underside Lower Body Color. Includes Handles A16609 and Hood Clip Brackets A16750CL and Steel Hood Rods.

A16610AR 1928 Price Ea. \$ 405.00



1928-29 Stock Hood

This hood fits the '28-'29 Model A's. Trophy Quality. Paint Underside Lower Body Color. Includes Handles A16609 and Hood Clip Brackets A16750CL and Steel Hood Rods.

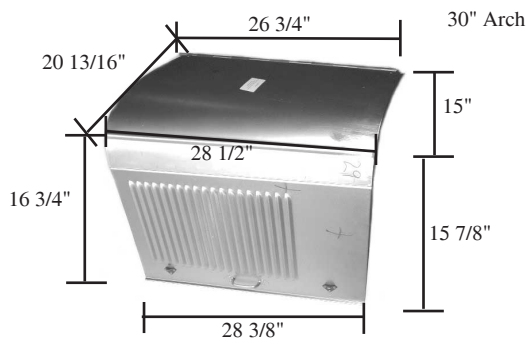

A16610A 28-29 Price Ea. \$ 380.00

1930-31 Stock Hood

All the '30-'31 Model A's used this hood. Trophy Quality. Paint Underside Lower Body Color. Includes Handles A16609 and Hood Clip Brackets A16750CL and Steel Hood Rods.

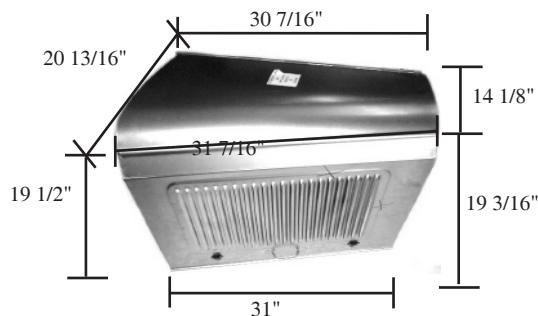

A16610B 30-31 Price Ea. \$ 420.00

OPEN CARS

Mike's "A" FORD-ABLE Parts

Stainless Hood Rods

Complete set of three hood rods. After punching these rods out about 1", use a variable speed drill, chuck it to the rod and spin the rod as you pull it out.

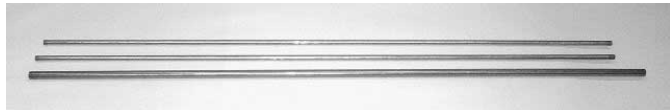

A16611A	28-29	27 3/4" Long	Price Set/3	\$ 14.95
A16611B	30-31	30 1/2" Long	Price Set/3	\$ 14.95

Hood Corners

Triangle leather hood corners originally were on the rear only. Use Rivet Tool RA2022 on Page Gen. 28. Rivets to be painted black.

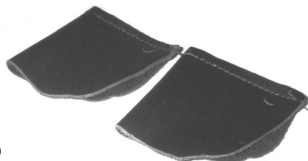

A16622LS	28-31	9/64 x 5/16 tubular rivets	Price Pair	\$ 3.90
----------	-------	----------------------------	------------	---------

Hood Corners

These are molded rubber hood corners; look good. Use Rivet Tool RA2022 on Page Gen. 28.



A16622RS	28-31		Price Pair	\$ 3.90
----------	-------	--	------------	---------

Hood Shelf

Not used on 1930-1931. See diagram on Page Open 22. Don't forget A16727S Blocks.



A16713/14	28-29		Price Pair	\$ 33.95
-----------	-------	--	------------	----------

Hood Shelf Blocks

These wooden blocks go under the hood shelf. They act as spacers to mount the hood latch.

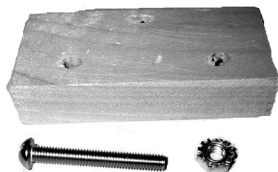

A16727S	28-29		Price Set/40	\$ 6.75
---------	-------	--	--------------	---------

Center Hood Bracket

Attaches to the frame with rubber bumper (A16761B - See Page Open 24) against the hood to prevent rattles.



A16718S	30-31		Price Set/12	\$ 5.50
---------	-------	--	--------------	---------

Hood Retainer (Front)

The center hood rod hooks onto this clip on the radiator shell. Paint Black



A8220C	28-31		Price Ea.	\$ 3.15
--------	-------	--	-----------	---------

Hood Retainer Mount Set (Front)

A pair of tube rivets to mount the center hood rod brackets. Use Rivet Tool RA2022 Page Gen. 28.



A8220MB	28-31		Price Pair	\$ 0.50
---------	-------	--	------------	---------

Hood Rod Retainer (Rear)

This is the rear retainer for the hood. Paint body color.

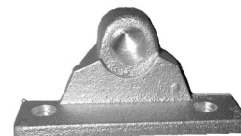

A16735A	28-29		Price Ea.	\$ 5.10
---------	-------	--	-----------	---------

Standard Hood Hinge Rod Retainer (Rear)

Same as above but for different years. Paint body color.

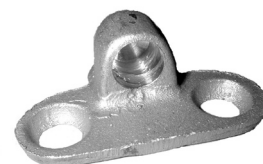

A16735B	30-31		Price Ea.	\$ 4.95
---------	-------	--	-----------	---------

Deluxe Hood Hinge Rod Retainer (Rear) Chrome

This serves the same purpose as A16735B, but has a finger which clamps over the cowl band. Normally only used on Deluxe '30-'31 Models. Order A16735BMB Screws - below.



A16735C	30-31		Price Ea.	\$ 8.75
---------	-------	--	-----------	---------

Retainer Mounting Screws (Rear)

Screws to mount the rear hood retainer to the firewall.



A16735AMB	28-29	2 x 12-24" x 5/8" round head	Price Set/6	\$ 0.95
-----------	-------	------------------------------	-------------	---------



A16735BMB	30-31	2 x 12-24" x 5/8" flat head	Price Set/4	\$ 0.95
-----------	-------	-----------------------------	-------------	---------

INSTALLATION OF HOOD SHELF
FOR 1928 - 1929 ONLY

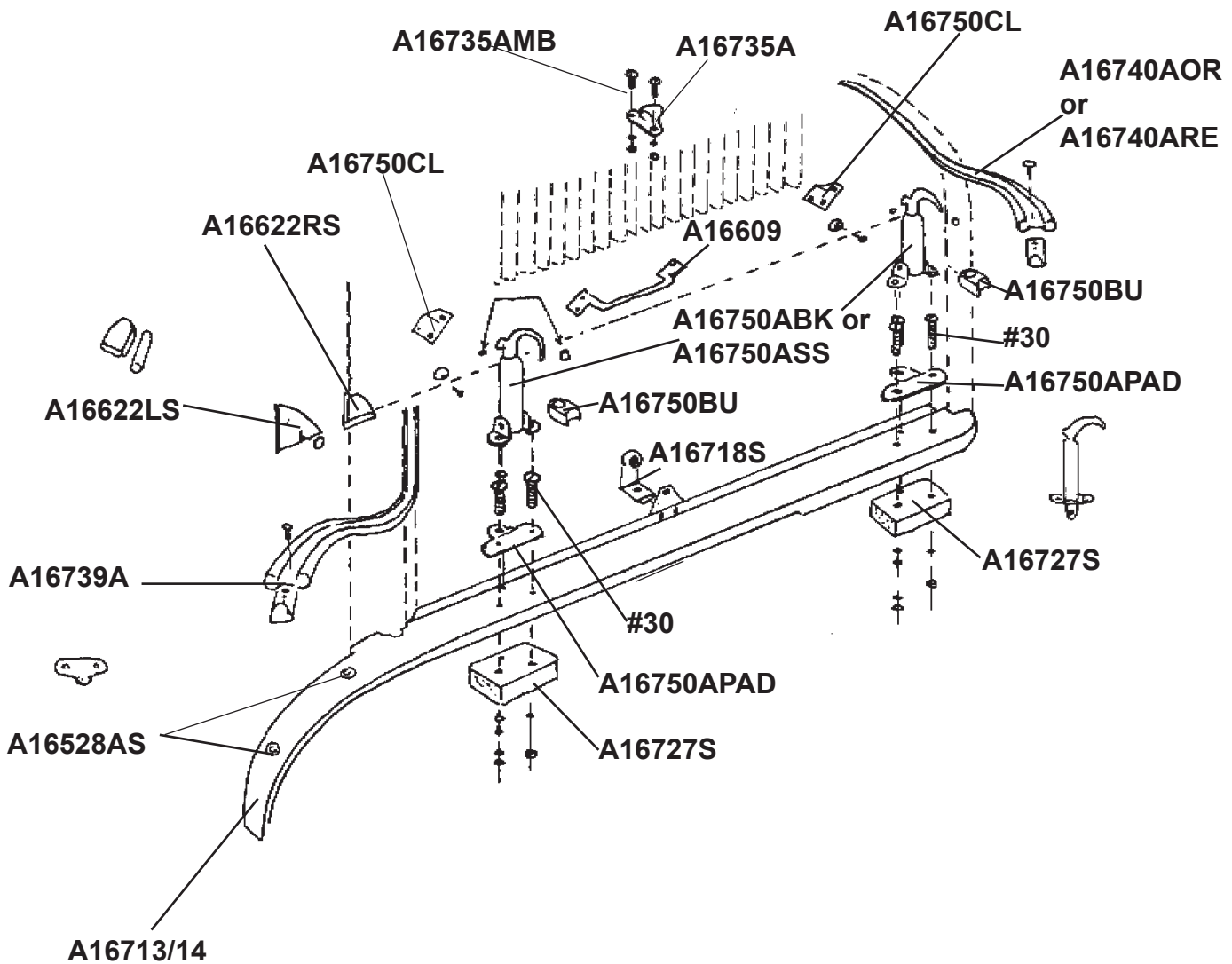

OPEN CARS

Mike's "A" FORD-ABLE Parts

Hood Retainer Shims

Having alignment problems with your hood? Place these steel shims between the rear hood retainer and the cowl. Will help if the bottom of the hood is hitting on the radiator shell.

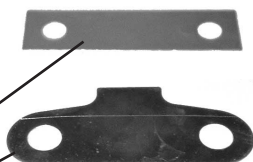

A16736A	28-29	Price Ea.	\$ 0.55
A16736B	30-31	Price Ea.	\$ 0.60

Cowl Band

This is a well made stainless steel reproduction. These '30-'31 reproduction bands will not fit the '28-'29's.

Special box for UPS - additional shipping charges do apply.

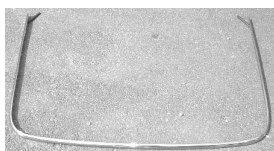

A16737CB	30-31	Price Ea.	\$ 73.00
----------	-------	-----------	----------

Cowl Band Clips

These clips go under the cowl panel screws on the firewall and slip under the cowl band to hold it in place.



A16738CL	30-31	Price Pair	\$ 3.35
----------	-------	------------	---------

Radiator Shell Lacing

This is a double beaded lacing for the radiator shell, comes with raven rivets.



A16739A	28-29	Price Set/25	\$ 6.75
---------	-------	--------------	---------

A16739B	30-31	Price Set/25	\$ 9.00
---------	-------	--------------	---------

Cowl Lacing Hook

This is the special hook that the wire attaches to, to hold the cowl lacing on. 10-32 x 3/4" Special Clamp Screw Used with original A16740AOR. Not included in lacing Kit A16740ARE or AOR.



A16739AC	28-29	Price Set	\$ 1.95
----------	-------	-----------	---------

Cowl Lacing Kit & Rivets

Two types are available for the '28-'29 A's. The original used wire to hold the lacing down on the gas tank and rivets on the cowl panels. Use Rivet Tool RA2022 on page Gen. 28.



A16740ARE	28-29	Replacement	Price Kit	\$ 8.60
-----------	-------	-------------	-----------	---------

A16740AOR	28-29	Original	Price Kit	\$ 12.75
-----------	-------	----------	-----------	----------

Cowl Lacing Screws

Special pan headed replacement screws for installing the '30-'31 cowl lacing. Included in the cowl lacing kit (A16740BS). One for each side and the third top center. 3 12-24 pan head screws



A16740MB	30-31	Price Set/3	\$ 0.75
----------	-------	-------------	---------

Authentic Cowl Lacing Kit

Just like the original for '30-'31 A's. Complete with all clips, screws, and rivets. Use rivet Tool RA2022 on page Gen. 28.



A16740BS	30-31	Price Kit/10	\$ 15.45
----------	-------	--------------	----------

1930-31 Cowl Lacing Clip

Replacement clips for the '30-'31's if you've lost some. Included with kit A16740BS.

Use Rivet Tool RA2022 on page Gen. 28.



A16737	30-31	Price Ea.	\$ 0.75
--------	-------	-----------	---------

Cowl or Radiator Rivets

This is a package of 24 raven-finished split rivets to attach the hood lacing.



A16745	ANY	Price Set/24	\$ 1.20
--------	-----	--------------	---------

Hood Latch Repair Kit

If possible try to repair your original latch handles. Our set does all 4 latches and comes with complete instructions.



A16749	28-31	Price Set/12	\$ 12.50
--------	-------	--------------	----------

Hood Latch Handle

We have both the original black three-hole handles as well as stainless steel.



A16750ABK	28-29	Black	Price Ea.	\$ 8.25
-----------	-------	-------	-----------	---------

A16750ASS	28-29	Stainless - 3 Hole Mounting	Price Ea.	\$ 11.00
-----------	-------	-----------------------------	-----------	----------



#30	28-29	Hood Handle Screws	Price Set/36	\$ 2.25
-----	-------	--------------------	--------------	---------

Mike's "A" FORD-ABLE Parts

Hood Latch Pads

These 4 rubber pads go under the hood latches.



A16750APAD 28-29 Price Set/4 \$ 4.10



A16750BPAD 30-31 Price Set/4 \$ 4.10

Hood Latch Handle

We have both the original black two-hole handles plus modern stainless steel.



A16750BBK 30-31 Black Price Ea. \$ 8.25

A16750BSS 30-31 Stainless - 2 Hole Mounting Price Ea. \$ 11.00



#32 30-31 Hood Handle Screws Price Set/24 \$ 2.25

Hood Latch Rivet Kit

These tiny rivets connect the body of the hood latch to the mounting bracket. Use Rivet Tool RA2022 on page Gen. 28.



A16751 28-31 Price Set/4 \$ 0.50

Hood Latch Caps

This set of 8 rubber caps protects your finish from being scratched. 1 Set will do all four handles.



A16750CS 28-31 Price Set/8 \$ 1.45

Hood Latch Bumper

Set of 4 rubber bumpers that fit over the hood latch stem to reduce rattles. This Latch bumper set cannot be used if you are using the Hood Bumper Set A16761 or A16761B.



A16750BU 28-31 Price Set/4 \$ 3.00

Hood Bumper Set

Complete set of 6 round rubber hood bumpers with rivets. Four for the hood and two for the centre hood braces. Place one under each hood clip plus one on each support clip.

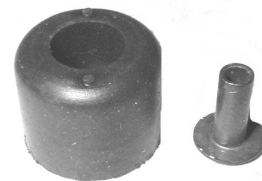

Use Rivet Tool RA2022 on page Gen. 28.

A16761 28-31 from Aug 28 to May 31 Price Set/12 \$ 3.50

Hood Bumper Set

Complete set of 2 round rubber bumpers for the inside center support plus 4 triangular ones to go under each hood clip. The supplier ships with rivets which is correct, but Mike recommends using rivet head screws and nuts to keep them in place.



A16761B 1931 May 31 'til end Price Set/12 \$ 3.75



1928 RHD Phaeton which resides in South Africa with Mr. H. Heyn.

OPEN CARS

Roadster Rumble & Trunk Parts

Deck Lids

Mike has excellent steel rear deck lids with the D-nuts already attached for your hinges.

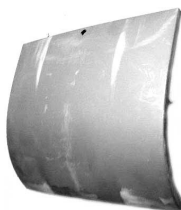

A1059AR	28-29	Steel - Rumble	Price Ea.	\$ 495.00
A1059AT	28-29	Steel - Trunk	Price Ea.	\$ 495.00
A1059BR	30-31	Steel - Rumble	Price Ea.	\$ 495.00
A1059BT	30-31	Steel - Trunk	Price Ea.	\$ 495.00
A1059ABS	28-31	Steel Deck Lid Skin	Price Ea.	\$ 200.00

Deck Lid Inner Panels

Mike now has this Inner Trunk or Rumble Panel available for your Roadster.



A1059A1T	28-29	Trunk	Price Ea.	\$ 276.00
A1059B1T	30-31	Trunk	Price Ea.	\$ 276.00
A1059A1S	28-29	Rumble	Price Ea.	\$ 276.00
A1059B1S	30-31	Rumble	Price Ea.	\$ 276.00

Rumble Floor Mat & Studs

Mike has the Rumble mats and studs available.
4 Piece Set.

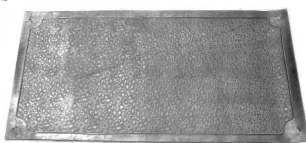

A2054	28-31	Mat	Price Ea.	\$ 34.95
A2057MB	28-31	Studs	Price Set/8	\$ 5.65

Rumble Stop Kit

This complete set fits all years. You will need to drill the holes in this. The upper part is aluminum while the lower is stamped steel. The part with the rubber stop is on the top and the other is used under the seat frame as a brace. 52 Piece Set.

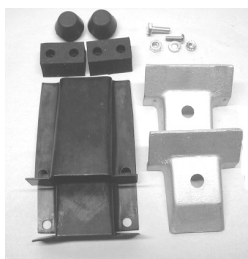

A41485CS	28-31		Price Set/52	\$ 19.00
----------	-------	--	--------------	----------

Grab Handles / Top Rest Rail

Mike has these stainless steel handles which mount on each side of the rumble seat. The top rests on these when folded down. Screws and nuts supplied. See A41500RB for Brace.

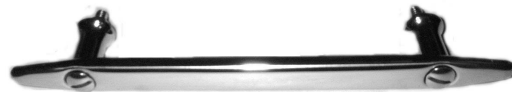

A41500SS	28-31	Price Pair	\$ 36.85
----------	-------	------------	----------

Grab Handle Positions

1928 - 1929 Roadster

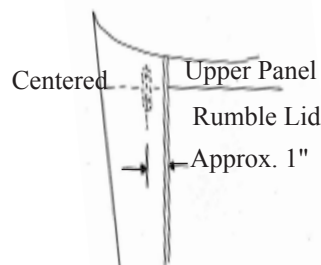

1930 - 1931 Roadster

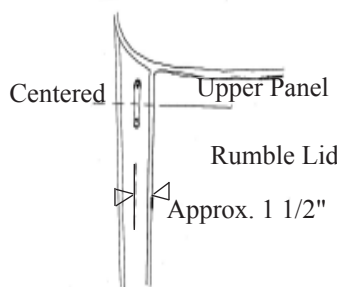

Top Rest Spacer Pads

A set of 4 thin rubber gaskets that are located on the bottom of the spacer to protect the paint.

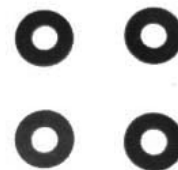

A41502	28-32	Price Set/4	\$ 0.70
--------	-------	-------------	---------

Grab Handle Braces

These stamped steel braces go under the quarter panel for reinforcement where the handles mount.

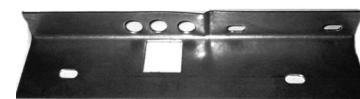

A41500RB	28-31	Price Pair	\$ 24.00
----------	-------	------------	----------

Mike's "A" FORD-ABLE Parts

Grab Handle Screws

This is a set of 4 each screws, nuts, and lock washers to attach your rumble seat grab handles. Included with A41500SS - See Page Open 25.



#39 28-31 Price Set/12 \$ 1.75

Rumble Alignment Plates

These fit into the top corners of the rumble rain gutter to align the rear lid when you close it.

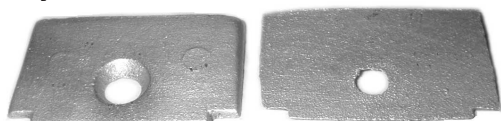

A41506 28-31 Price Pair \$ 3.45

Trunk Alignment Plates

These fit into the lower end of the trunk rain gutter to align the rear lid when you close it.



A41506TR 28-31 Price Set/8 \$ 6.25

Rumble Lid Bumper Set

Here is a complete set of rubber stops for the top and bottom of the rumble lid. Comes in Kit A41485CS.



A41484S 28-31 Price Set/4 \$ 3.95

Rumble Lid Bumper Bracket

These steel brackets go in the upper corner of the rumble rain gutter to hold the rubber stops. Need 2.

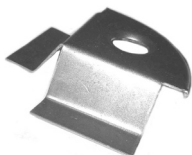

A41517 28-31 Price Ea. \$ 12.75

Rumble or Trunk Rubber Bumpers

This pair of rubber bumpers is used for either the upper corners of the rumble or the lower corners of the trunk. Comes in Kit A41485CS.



A41518 28-31 Price Pair \$ 1.75

Rumble Seat Hinge Kit

Here's all the hardware including hinges, braces, nuts, bolts, and lockwashers to mount the rumble seat. Note: 42 Piece Set.

A flat washer may be needed to shim between the hinge bracket and the deck lid.



A41543S 28-31 Price Set/42 \$ 31.95

Rumble Hinge Screws

This set of 12 screws is used to attach the rumble hinges to the rumble lid.



A41544MB 28-31 Price Set/12 \$ 1.80

Trunk Lid Hinges

You will need these hinges to mount your deck lid as a standard lift-up trunk. This is a quality USA Product and contains everything that you will need.



A41512S 28-31 Price Set/22 \$ 49.95

Rumble Hinge Pivot Bolts

This complete set of special shoulder bolts, square washers, and nuts is used where the rumble lid pivots. 38 Piece Set.



A41543MB 28-31 Price Set/38 \$ 6.95

Trunk Lid Support

If you've ever had a trunk come down on your head, you know how important this support is to hold up the deck lid.

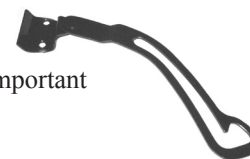

A41530A 28-31 Price Ea. \$ 16.95

Trunk Lid Support Bolt Kit

The bolt kit needed to install the install the A41530A Trunk Lid Support.



A41530MB 28-31 Price Set \$ 5.45

OPEN CARS

Mike's "A" FORD-ABLE Parts

Rumble Striker

If you're converting to a rumble you need this type striker plate for the rumble lock.
7 Piece Set.

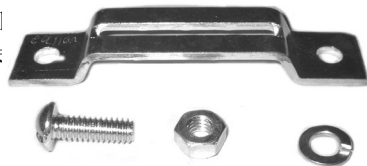

A52500S 28-32 Price Set/7 \$ 2.40

Trunk Striker

If you're using the rumble as a trunk, you'll need this to latch your lid.
10 Piece Set.
Screws Included.



A41615 28-31 Price Set/10 \$ 6.00

Rumble / Trunk Lid Lock

This lock unit mounts inside the rumble lid.
'28 - '29 Rumble Lid
'28 - '31 Trunk Lid



A52501 28-31 Price Ea. \$ 14.25

Trunk / Rumble Handle Assembly

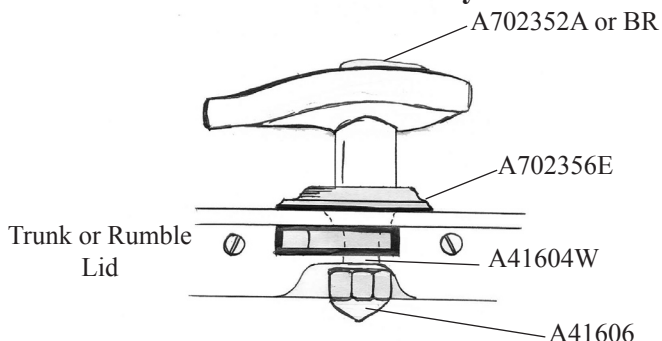

Rumble Lock

This lock unit mounts inside the rumble lid for the '30-'31's.

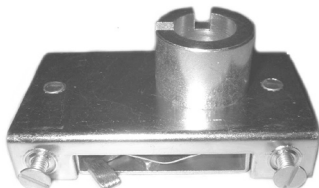

A52502 30-34 Price Ea. \$ 14.25

Rumble & Trunk Handle Lock Washer

This special type lock washer slides over the threaded shank and bends over the acorn nut A41606 when it's attached.

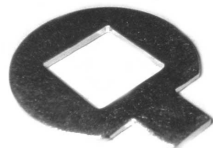

A41604W 28-31 Price Ea. \$ 0.70

Rumble & Trunk Handle Acorn Nut

This is the special acorn nut that holds the rumble handle in place.



A41606 28-31 Price Ea. \$ 1.45

Rumble or Trunk Lid Handle

This chrome-plated locking rumble handle fits the **Roadster**.
Key Included.



A702352A 28-31 Price Ea. \$ 38.00

Rumble or Trunk Handle Pad

This is the rubber pad that fits between the rumble handle and the lid.



A702356E 28-31 Price Ea. \$ 0.50

Rumble Step Plate

This square step plate was used until 2/29. One goes on the fender and one on the bumper bracket.

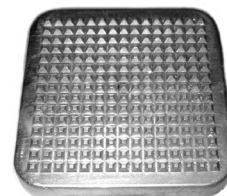

A41563S 28-29 Price Ea. \$ 7.60

Rumble Step Plate

This round cast aluminum step plate was used after 2/29. One goes on the fender and one on the bumper bracket.



A41563R 29-31 Price Ea. \$ 6.75

Rumble Step Plate Pads

These rubber pads have a good bead around the outer edge. Use one between the step plate and the fender.



A41563SP 28-29 Square Price Ea. \$ 2.25



A41564RP 29-31 Round Price Ea. \$ 2.05

Mike's "A" FORD-ABLE Parts

Rumble Step Plate Bracket

This cast iron bracket bolts onto the bumper brackets for your rumble step plate.

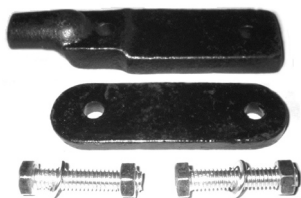

A41572 28-31 Price Set \$ 6.95

Complete Trunk to Rumble Seat Conversion for a 1930-1931 Car.

1 - A1059BR	Steel Deck Lids	\$	495.00
1 - A41485CS	Rumble Stop Kit	\$	19.00
1 - A41500SS	Grab Handles & Screws	\$	36.85
1 - A41500RB	Grab Handle Brackets	\$	24.00
1 - A41506	Alignment Plates	\$	3.45
2 - A41517	Rumble Lid		
	Bumper Bracket	\$ 12.75	\$ 25.50
1 - A41543S	Rumble Seat Hinge Kit	\$	31.95
1 - A52500S	Striker	\$	2.40
1 - A52502	Rumble Lock	\$	14.25
1 - A702352A	Rumble Handle	\$	38.00
1 - A702356E	Rumble Handle Pad	\$	0.50
1 - A41604W	Lock Washer	\$	0.70
1 - A41606	Acorn Nut	\$	1.45
2 - A41563R	Rumble Step Plate	\$ 6.75	\$ 13.50
1 - A41564RP	Step Plate Pad	\$	2.05
1 - A41572	Step Plate Bracket	\$	6.95
1 - A166A or B	Fenderwell Support	\$	51.00
1 - A161A	Curved Inner Panel	\$	40.00
1 - A162A or B	Hinge Brace	\$	51.00
1 - A159A	Rumble Seat Platform	\$	69.00
1 - A1401	Spare Tire Support	\$	7.10
1 - S106 or S307	Rear Seat Cushion Spring	\$	64.25
1 - S107 or S308	Rear Seat Backrest Spring	\$	83.75
1 - UOC103RR31	Upholstery Kits - Page Gen. 224	\$	
1 - KP52RR31	Rumble Panel Kits- Page Gen. 229	\$	
1 - A2054	Rumble Mat	\$	34.95
1 - A2057MB	Floor Mat Studs	\$	5.65

SHIPPING & UPHOLSTERY NOT INCLUDED IN PRICE
TOTAL \$ 1122.25

Please Note:

For '28 - '29, just follow the years advertised under each item. The above list is a guide line only. Give us a call when you are ready to go to work on your Trunk to Rumble Conversion.

See Mechanics Handbook - Vol. II for complete Instructions - Order A91029



1928 Phaeton owned and restored by Mr. & Mrs. D. Garmon.



OPEN CARS

Roadster & Phaeton Windshields & Parts

Open Car - 1928 - 1929 Roadster & Phaeton Windshield Components

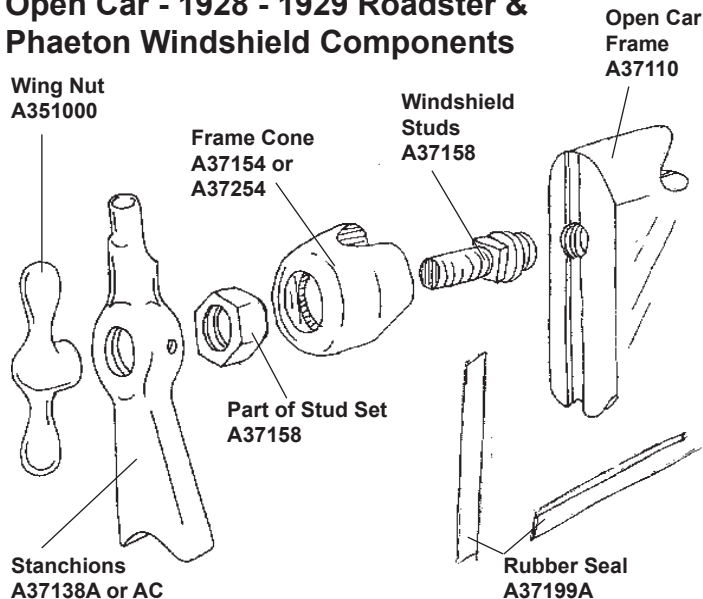

Open Car Glass Bedding

The correct cork / neoprene bedding used for setting glass into the windshield frame.



A3402X 28-31 Price Ea. \$ 7.50

Windshield Frames. Open A's

These frames are for the open car only. They are made from round tubing and can be bought in plain finish to be painted or in chrome.

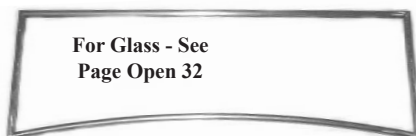

'28 - '29	14 5/8"			
'30 - '31 Std	15 1/4"	- Stanchions	13 1/2"	
'30 - '31 Dlx	13 1/2"	- Stanchions	12 1/8"	
A37110AP	28-29	Plain		
		Price Ea.		\$ 210.00
A37110AC	28-29	Chrome		
		Price Ea.		\$ 370.00
A37110BPS	30-31	Standard Plain		
		Price Ea.		\$ 205.00
A37110BCS	30-31	Standard Chrome		
		Price Ea.		\$ 370.00
A37110BPD	30-31	Deluxe Plain		
		Price Ea.		\$ 205.00
A37110BCD	30-31	Deluxe Chrome		
		Price Ea.		\$ 370.00

Open Car Windshield Stanchion

Sold in pairs, these stanchions are authentic stamped steel reproductions for the Phaeton and Roadster. Has sockets and liners installed. Deluxe Length 12 1/2" Standard Length 13 3/8".



A37138A	28-29	Plain	Price Pair	\$ 195.00
A37138AC	28-29	Stainless	Price Pair	\$ 215.00

Open Car Windshield Stanchions

For the Standard '30-'31 Roadster, use these regular steel stanchions which can be painted as original. Has sockets and liners installed.



A37138PST	30-31	Plain Steel	Price Pair	\$ 275.00
-----------	-------	-------------	------------	-----------

Open Car Windshield Stanchions

These are stainless steel stanchions for the Standard Roadster. Comes complete with sockets and post liner.



A37138STD	30-31	Stainless	Price Pair	\$ 280.00
-----------	-------	-----------	------------	-----------

Open Car Windshield Stanchions

For the Deluxe Roadster, these stainless steel stanchions are great. They come complete with sockets and post liner. The left side is tapped for mirror.



A37138B	30-31	Deluxe - Stainless	Price Pair	\$ 265.00
---------	-------	--------------------	------------	-----------

Open Car Stanchion Horns

These bronze cast horns go at the top of the cowl. The lower stanchions are screwed into these. Used on: '30 - '31 Roadsters and Phaetons.

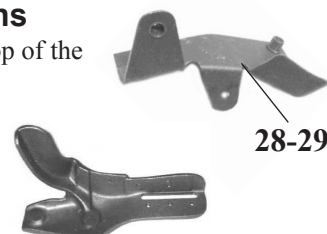

A1001AB	28-29	Price Pair	\$ 45.00
A1013B	30-31	Price Pair	\$ 205.00

Mike's "A" FORD-ABLE Parts

Open Car Lower Stanchion

Mike also has these pressed steel stanchions for the **Standard** and **Deluxe Roadsters**. Sold in pairs. For Dash Rail Brackets see **Page Open 12**.



A37130ST 30-31 Plain Price Pair \$ 130.00



A37130STC 30-31 Stainless Price Pair \$ 277.50

Open Car Stanchion Spacer

This pair of lead spacers are molded joined, so you'll have to break them apart. The spacer fits between the dash rail and the stanchion.



A371301 30-31 Price Pair \$ 8.10

Open Car Stanchion Screws

Each set of 4 screws is correct for the years indicated. **1928-1929** used 5/16-18 oval head screws. **1930** used a 5/16-24 oval head screw. **1931** used a 5/16-24 Hex head screw with a screwdriver slot. Paint screws body color.



A37135ABR 28-29 Price Set/4 \$ 3.00
 A37135BBR 1930 Price Set/4 \$ 5.00
 A37135CBR 1931 Price Set/4 \$ 5.20

Windshield Post Sockets

This is a steel socket that mounts on the windshield post for the windshield to fit into.



A37137L 30-31 Lower Price Ea. \$ 11.00



A37137S 30-31 Upper Price Ea. \$ 11.00

Open Car Finger Pulls

These finger pulls were used on the windshield frame of all open cars to pull the windshield shut.



Includes 10/32 x 1" # 8 Oval head Screws.
 B37118S 28-36 Price Pair \$ 9.35

Open Car Post Liners

These liners fit into the windshield stanchion on the open cars. These are not needed if a complete stanchion set is bought.



A37138PLS 30-31 Std Price Ea. \$ 22.00
 A37138PL 30-31 Deluxe Price Ea. \$ 14.50

Open Car Wing Nuts

You'll need 2 of these for your '28-'29 open car or 4 for your '30-'31. All use 2 at the top where the windshield pivots plus the latter use 2 more to attach the upper and lower stanchions.



A351000 28-31 Price Ea. \$ 2.85

Open Car Wing Nut Washers

These stainless steel washers go between the wing nut and the stanchion. 4 per set.



A351000BR 28-31 Price Set/4 \$ 1.15

Open Car Frame Cones

This cone is used at the pivot point between the windshield frame and the stanchion. Stanchion post upper cups have round slot machined at an angle as original to conform to windshield side angle which is wider at top. The side having the higher or thicker side (from bottom) is installed down.



A37154R 30-31 Deluxe - Chrome Price Ea. \$ 5.00
 A37254 28-31 Black - Standard Price Ea. \$ 5.00

Open Car Windshield Studs

This set of replacement studs are used where the open car windshield pivots. Pair of Studs and Nuts.



A37158 28-31 Price Set \$ 4.95

Open Car Windshield Gasket Set

This set of rubber gaskets is used on the open car windshield. Enough for sides and bottom of frame.



A37199A 28-29 Price Set \$ 4.50
 A37199B 30-31 Price Set \$ 4.75

OPEN CARS

Mike's "A" FORD-ABLE Parts

Windshield Fastener Set

This set contains the male studs that screw into the windshield post for the side curtains and the snaps for the top of the windshield where the top attaches.



A37103 28-31 Price Set \$ 20.75

Windshield Post Curtain Studs

12 Original type studs made from brass. Nickel plated. 2 Long & 10 Short.



A37160 28-35 Price Set \$ 9.25

Windshield Snaps

Brass, Nickel plated for the curtains. Used on original windshield frames. Need 6 per Windshield. Press in Style as original, and screw in 10/32 style available.



For a full set see A37103 above.

A37170 28-31 Press-In Price Ea. \$ 2.10

For Body Sockets and Side Curtain Fasteners - See Page Gen. 233.

Order Online Now and Save 5%

Visit our website for all your Model "A" needs.



www.mikes-afordable.com



1930-31 DELUXE ROADSTER (40-B)

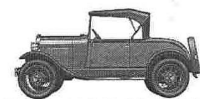

1928-29 STANDARD ROADSTER (40-A)



1930-31 STANDARD ROADSTER (40-B)



1931 Roadster owned by Mr. R. DeRenzis

Mike's "A" FORD-ABLE Parts

Glass Sets

PLEASE NOTE: All glass is clear AS1 safety glass 1/4" thick. This safety glass works very well and presents no fitting or installation problems. Your glass will be shipped by UPS in special boxes that will ensure safe delivery. Most shipments will be made within 14 working days of the receipt of your order and WILL require additional shipping charges. Shipping charges do apply to glass picked up at our store.

The following codes are used below to describe the glass:

W = Windshield D = Door Glass

Q = Quarter Glass B = Back Glass

Where "DD" appears it indicates 2 Door Windows, "QQ" indicates 2 Quarter Windows, ETC.

PLEASE MAKE SURE TO SPECIFY THE EXACT YEAR AND BODY STYLE OF YOUR CAR.

W, B - Standard Roadster 40B STD & Standard Phaeton 35B
AG4 30-31 Price Set \$ 162.80

W, B - Deluxe Roadster 40B DEL. & Deluxe Phaeton 180A
AG6 30-31 Price Set \$ 162.80

Individual Glass Pieces

One Piece Windshield - Roadster 40A or Phaeton 35A
AG1 28-29 Price Ea. \$ 121.00

One Piece Windshield - Standard Roadster 40B STD & Phaeton 35B
AG2 30-31 Price Ea. \$ 121.00

One Piece Windshield - Deluxe Roadster 40B Del & Deluxe Phaeton 180A
AG3 30-31 Price Ea. \$ 121.00

Ford Script Logo Etched on Glass

1928 - 1929 Windshields for cars.

A94999A 28-31 Price Ea. \$ 16.50



1930 - 1931 Windshields for Cars
May 1931 thru 1931 all glass optional.

A94999C 30-31 Price Ea. \$ 16.50



OPEN CARS



Mike's second car in South Africa.
1929 RHD Roadster.

Windshield Wiper Parts

There are not any New Wiper Motors available for the Open Cars. You will need to find an original and have it restored. The items listed are replacement pieces for original Electric and Vacuum Motors.

Hand Wiper

This is the chrome plated hand wiper that was used on all '28 Open Cars.



A17655AR 28-30 Price Ea. \$ 21.00

Electric Wiper Connection

These connections are used on all the electric wipers to connect the wire to the wiper motor.



A17675 28-30 Price Ea. \$ 5.50

Electric Wiper Wire Kit

Replace your dirty, cracked wiper wire with this correct black and blue cloth-covered wire. It runs from the terminal box to the wiper motor and has the flag connector for the terminal box end.



A17500WK 28-31 Price Ea. \$ 3.75

Wiper Wire Clip - Open Cars

This clip holds the electric wire on the windshield frame for the Open Car only.



A17659 28-30 Price Ea. \$ 2.75

Wiper Hose Clip - Open Cars

This clip goes on the windshield of the Roadsters & Phaetons to hold the wiper hose.



A17669 28-31 Price Set \$ 1.45

Electric Wiper Wire Clip

You will need three of these to hold the wiper motor wire to the header.



A17616A 28-30 Price Ea. \$ 1.50

Wiper Light Wire Support

This clip was held in place by a bolt that held the gas tank to the cowl. It served as a grommet holder for the wiper and the other part of the clip held the top of the kick panel in place.



Grommet included. 2 Required.

A14591 28-29 Price Ea. \$ 4.30

A14591GR Grommet Only Price Ea. \$ 0.70

Electric Wiper Wire Supports

You will need three of these to hold the wire which goes to the wiper motor plus to support the cowl light wire. Need 3 per Car.

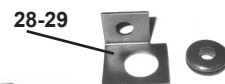

A14593A 28-29 Price Ea. \$ 2.25
A14593 30-31 Price Ea. \$ 2.90

Wiper Clamps (Open Cars)

These are the chrome clamps which hold the wiper motor to the windshield frame.



A17589SS 28-31 Price Set/4 \$ 5.10

***** MIKES TIPS *****

Use only Replacement Blades with Replacement Arms and Show Blades with Show Arms.

Replacement Wiper Arm (Stainless)

If your wiper motor mounted inside the car, this is the arm to use.



A17565F 1931 Price Ea. \$ 4.40

Replacement Electric Wiper Blade

These wiper blades fit all Model A Replacement arms.



A17528 28-29 7-1/4" Blade Price Ea. \$ 2.50
A17528B 30-31 8-1/4" Blade Price Ea. \$ 2.75

Show Electric (Flat) Tension Arm

This exact reproduction arm has been heat treated and cadmium plated. Includes the Special Square Head Tension Bolt, Knurled Nut and Cotter Pin. Not Stamped with Trico - 6 1/2" Cad.



A17565A 1928 - June 1929 Price Ea. \$ 21.95

Show Electric Wiper Blade

8" Nickel Plated, Single Ply Blade with Cotter Pin Hole. Use A17565A Arm.



A17506C 1928 - March 1929 - Open Cars Price Ea. \$ 16.50

OPEN CARS

Mike's "A" FORD-ABLE Parts

Show Electric Wiper Blade

8 1/4" Nickel Plated, Contoured Top, Multi-Ply Blade with Cotter Pin Hole. Use A17565A Arm.



A17506D April 1929 - June 1930
Price Ea. \$ 16.50

Show Electric Wiper Blade

8 1/4" Black, Multi Ply, Universal Use Blade with Cotter Pin Hole. Use A17565A Arm.



A17506E Price Ea. \$ 14.50

Show Electric Wiper Blade

8 1/4" Chrome blade with single arm rivet clip, five ply rubber. July 30 - End 31 - Deluxe open cars with Vacuum Wipers.



A17506G 29-31 Price Ea. \$ 14.80

Wiper Mounting Boots

These rubber boots slipped onto the mounting ears of the original electric wiper motors.



A17595AR 1928 Closed end Price Ea. \$ 6.95

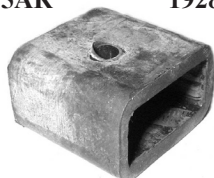

A17595B 28-30 Open End Price Ea. \$

Wiper Boot Plates

This plate goes on top of the wiper mounting boot on the later closed cars.

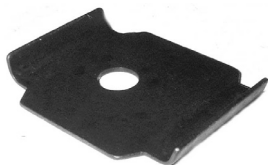

A17595P 29-30 Price Pair \$ 3.40

Wiper Motor Felt

This felt fits most motors in use today. It goes between wiper motor and the windshield frame on all closed cars. 3"x 5/8.

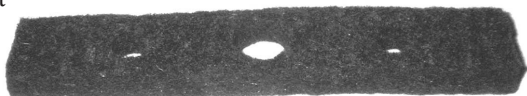

A17618 28-30 Price Ea. \$ 1.75

Manifold Hole Plug

This is the special slotted pipe plug which was used on the side of the block near the oil pump to let you see if your oil pump was working. This is also used for the valve fitting on the inlet manifold to plug the hole. To hold in the oil pump while changing the pan gaskets - use A6701 Page Gen. 118. This is also used to plug the intake manifold when an electric wiper is used.



A6621 28-31 Price Ea. \$ 0.65

Electric and Vacuum Tandem Wiper Kit

This kit allows you to add on a wiper for the passenger side so they can see, too! It will adapt to A17508 6V or 12 V Motor. Before drilling any holes, make sure the distance between the Motor Shaft and the Pivot Shaft is EQUAL to the length of the Link Rod Assembled to the Wiper Arm.



A17574 28-31 Price Set \$ 29.15

Vacuum Wiper Motor Control

Here's the on/off control for the outside mounted wiper motor. This passes through the windshield frame.

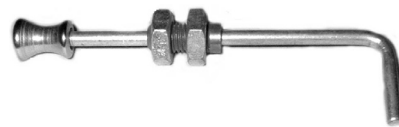

A17534 28-31 Price Ea. \$ 3.95

Vacuum Wiper Mounting Screws

Here are the screws needed to mount the vacuum wiper motor.



A17500OMB 30-31 Open Car Price Pair. \$ 1.10

Show Vacuum Arm

6 3/4" Black, Clip Type Arm used from June 1930 thru 1931 on Standard Open Cars.



A17565B 30-31 Price Ea. \$ 11.55

Show Vacuum Arm

6 3/4" Chrome, Clip Type Arm used from June 1930 thru 1931 on Deluxe Open Cars.



A17565C 30-31 Price Ea. \$ 13.20

Mike's "A" FORD-ABLE Parts

Show Vacuum Wiper Blade

8 1/4" Black, Single Rivet, Multi-Ply Blade with Clip for June 1930 - 1931 for Standard Open Cars.



A17506F 1929 - 1931 Price Ea. \$ 15.50

Show Vacuum Wiper Blade

8 1/4" Chrome blade with single arm rivet clip, five ply rubber. July 30 - End 31 - Deluxe open cars with Vacuum Wipers.



A17506G 29-31 Price Ea. \$ 16.50

Show Vacuum Wiper Blade

8 1/4" Black, Two Rivet, Multiply Blade with Clip for 1931 Standard Open Cars.



A17506H 1931 Price Ea. \$ 16.50

Show Vacuum Wiper Blade

8 1/4" Chrome, Two Rivet, Multi-Ply Blade with Clip for 1931 Deluxe Open Cars.



A17506I 1931 Price Ea. \$ 16.50

Trico Vacuum Wiper Bowl Gaskets

If you need only the bowl gaskets for your Trico motor, Mike's got them.



A17508G 29-31 Price Pair \$ 2.35

Trico Vacuum Wiper Motor Tag

If your Trico embossed tag has been painted or marred, replace it with this new one.



A17508T Price Ea. \$ 3.50

Chrome Vacuum Wiper Knob

Replace your worn knob with this new one.



A17513 28-31 Price Ea. \$ 1.75

Trico Vacuum Wiper Knob

If you want the knob with "TRICO" on it, this chrome-plated knob is for you.



A17513D 29-31 Price Ea. \$ 3.50

Open Car Stanchion Line

This is the chrome vacuum line for Roadsters and Phaetons. It mounts on the left side windshield stanchion. Mounting clips included.

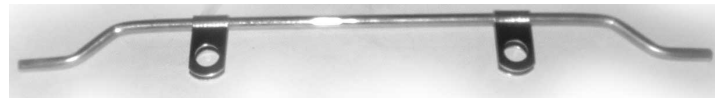

A17517S 30-32 Standard Price Ea. \$ 6.75

A17517D 30-32 Deluxe Price Ea. \$ 6.55

Open Cars use a rubber hose 13 1/2" long from the wiper motor to the stanchion tube, and 20 1/2" from the bottom of the stanchion tube, behind the kick panel to the steel vacuum line.

Vacuum Wiper Hose

Six feet of the small diameter hose for the wiper. Rubber. Used on all cabs with wipers.



A17520 28-31 6 Ft. Price Ea. \$ 1.45

Fabric Vacuum Wiper Hose

For the show car, Mike has this simulated fabric covered wiper hose. Used on all cabs with wipers.



A17520OR 30-31 Price Ea. \$ 6.00

Vacuum Wiper Hose Header Clips

This set of three clips hold the wiper hose in place under the windshield hinge on the Coupe. The hinge screws also secure these clips. Sold as a set of three.



A17616 30-31 Price Set/3 \$ 2.95

Manifold Vacuum Line Connector

This is the brass connector that screws into the intake manifold that you connect the vacuum line to.



Manifold Hole size - 1/8 - 27 Pipe Thread.
A17540 29-31 Price Ea. \$ 1.10

Mike's "A" FORD-ABLE Parts

Manifold Vacuum Line

Mike has the steel vacuum line with brass fittings included. This goes from the intake manifold up to the firewall.



A17543A 28-31 Price Ea. \$ 3.45

Manifold Vacuum Line Fittings

These are new quality vacuum line fittings. There are included with a new Manifold Vacuum Line A17543A or A17522.



A17543F 28-31 Price Ea. \$ 0.45

Firewall Vacuum Line Connector

This is the double female brass connector that attaches to the firewall for both inside and outside vacuum lines to connect.



Includes 1/2-20 Cad. Nut.

A17541 29-31 Price Ea. \$ 3.25

Inside Vacuum Line (Brass Fittings Included)

This is the steel vacuum line that goes from the firewall under the gas tank and up the stanchion on **Closed Cabs**. This can also be used on Open Cars from the firewall fitting across the firewall to the cowl panel.

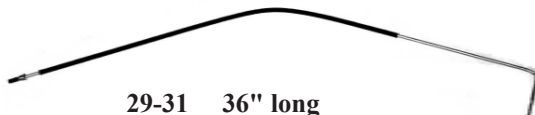

A17522 29-31 36" long Price Ea. \$ 3.95

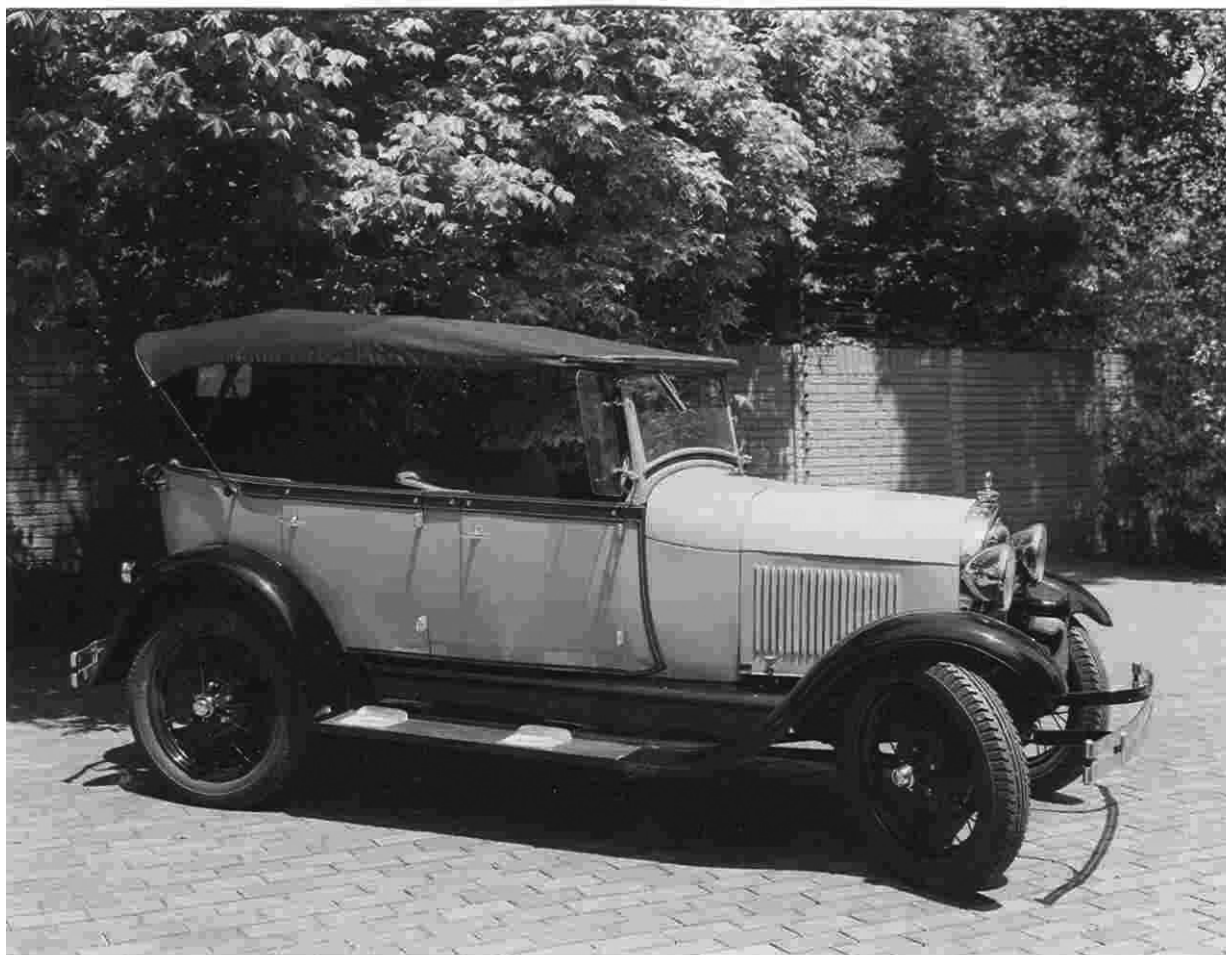

1929 RHD Phaeton owned and restored by Mr. Alan Hodgkiss of Petermaritzburg, South Africa.

OPEN CAR TOPS

TYPICAL STRAIGHT TOP WOOD TOP IRONS FOR A STANDARD ROADSTER PICKUP



TYPICAL STRAIGHT TOP WOOD TOP IRONS FOR A STANDARD PHAETON



Open Car Top Irons

Mike has the complete set of top irons which include, the hold down clamps, thumb screws, prop nuts, the wooden cross bows, top irons and rivets - ready to install.

A43501A	28-29	Standard Roadster	Price Set	\$ 535.00
A43501B	30-31	Standard Roadster	Price Set	\$ 535.00
A43501D	28-29	Roadster Pickup	Price Set	\$ 475.00
A43501E	30-31	Roadster Pickup	Price Set	\$ 485.00
A43501F	28-29	Standard Phaeton	Price Set	\$ 695.00
A43501G	30-31	Standard Phaeton	Price Set	\$ 695.00

Side View of a 1928-1929 Roadster Top Irons

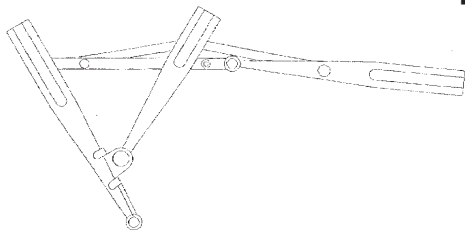

The '28-'29 Roadster has 3 Folding straps. The '30-'31 has only one main strap that pins into the center bow when up. The Windshield posts are about 44" center to center on a '28-'29 Roadster, but at least 2 inches wider on a '30-'31 Roadster (around 46".)

Deluxe Top Irons

If you've got the **Deluxe** car, you'll want these stainless steel - painted steel units. The painted part is light buff like the originals. Steam Bent Bows are not included with the Irons.

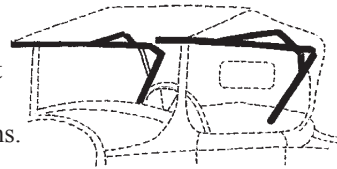

A43501C	30-31	Deluxe Roadster	Price Set	\$ 420.00
A43501H	30-31	Deluxe Phaeton	Price Set	\$ 690.00

Universal Top Iron Kit

This top iron assembly is manufactured to fit all Ford Roadsters from 1928 thru 1932, and will probably fit other makes of Roadsters as well. The kit is also designed to fit Ford Roadster Pickups from 1928 - 1934. Extra holes have been drilled to allow for the differences in body and windshield dimensions, and to allow for stock or chopped windshields. The header board comes pre-cut and formed, to be drilled on the Top Irons have been mounted to the windshield. The top bows are made in three sections, comprising of two rounded ends and a straight center piece, which is supplied longer than necessary, to be cut to length on the top irons to be fitted to the vehicle. This section then slides over two sleeves that protrude from the rounded ends, to complete the formation of the top bows. The kit is manufactured of steel, the header board is of premium hardwood, has stainless steel fasteners and is supplied with fitting instructions. The top can be lifted off in one piece, or folded down like original. Once mounted, the top irons are ready to go to the upholstery shop of your choice.



A43501MU	28-32	Price Set	\$ 490.00
----------	-------	-----------	-----------

Open Car Top Iron Rivet

These stainless steel rivets are used to hold the parts of the **Deluxe** top irons together. 9/32 X 1".



A43502RI	30-31	Price Ea.	\$ 1.00
----------	-------	-----------	---------

Open Car Top Mounting Studs

For **4 Door Phaetons**. These studs screws into the body where the top irons are attached. When the top is folded down, it pivots on this stud. Need 2 per car.

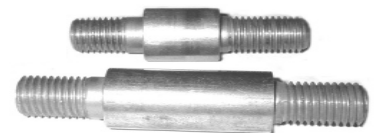

A36636A	28-29	Price Ea.	\$ 25.00
A36636B	30-31	Price Ea.	\$ 25.00

Mike's "A" FORD-ABLE Parts

Open Car Cross Bows (Straight Wood Bows)

If your top irons are in good shape but the cross bows are not, you can replace the wood with these.

A42056A	28-29	Roadster	Price Set	\$ 69.00
A42056B	28-29	Phaeton	Price Set	\$ 79.00
A42056C	30-31	Roadster	Price Set	\$ 69.00
A42056D	30-31	Phaeton	Price Set	\$ 79.00

Top Bow Screws

Set of 12 #10 x 3/4
Oval Head Stainless Screws.



A37200	28-31	Price Set	\$ 2.25
--------	-------	-----------	---------

Top Bow Tool

A handy tool to attach the wood bows to the metal top irons. Tool is made for standard air hammers and gives the rivet a truss head appearance.

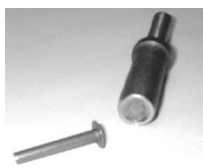

T43501T	28-31	Price Ea.	\$ 38.00
A43501R	Rivets	Price Ea.	\$ 0.40

Open Car Prop Knobs

These are authentic prop knobs to hold the top iron on the car. They are cadmium plated and ready to paint black like the originals. 1 1/2" diameter.



A37708	26-31	Std Roadster & Phaeton	Price Ea.	\$ 7.00
--------	-------	------------------------	-----------	---------

Same as above but the deluxe has a polished stainless steel head and steel back plate. 1 1/2" diameter.

A37708DEL	30-31	Roadster Knob 7/16" - 14 sq. nut	Price Ea.	\$ 8.45
-----------	-------	----------------------------------	-----------	---------

Open Car Top Mounting Bolt

This is the coarse-threaded carriage bolt used with the prop knob to hold the top iron on the car.



A37707	28-31	7/16" - 14 x 1" cap	Price Ea.	\$ 0.45
--------	-------	---------------------	-----------	---------

Roadster - Top Iron to Body Mounting Parts

Prop Knob
A37708

Top Bracket
A42070

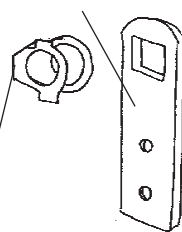
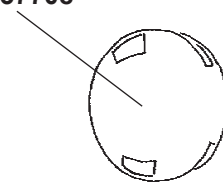

Top Mounting Bolt
A37707

Prop Nut Lock Washer
A52250

Open Car Prop Nut Lock Washer

The prop knobs used this special locking washer.



A52250	29-31	Price Ea.	\$ 1.65
--------	-------	-----------	---------

Open Car Top Brackets

These brackets mount on the body behind the doors for the top to mount on.

'28-'29 had a bend in them, '30-'31 are straight.

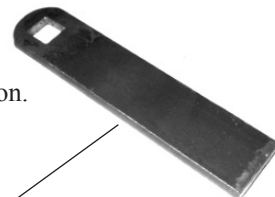

A42070AR	28-29	Price Ea.	\$ 8.95
A42070	30-31	Price Ea.	\$ 8.95

Open Car T Bolts

For the '30-'31 Deluxe, you need these T bolts and nuts to hold the cross bows to the top irons.



A180600	30-31	Price Pair	\$ 6.75
---------	-------	------------	---------

Open Car Top Hardware

This kit includes all the hardware you'll need to attach the wood cross bows to the top irons on the Deluxe Roadster.



UTP3080	30-31	Price Set	\$ 11.25
---------	-------	-----------	----------

Open Car Top Clamping Bracket

If your old irons are in good shape, these are new clamping brackets that hold the top to the window stanchions on the front corners.

These are on the new top iron kits.



A37323/24AR	28-29	Price Pair	\$ 42.95
A37323/24B	30-31 Std	Price Pair	\$ 42.95

Mike's "A" FORD-ABLE Parts

Open Car Top Clamping Screw

This chrome plated type of wing nut holds the top irons to the top of the windshield stanchion. These are cut so that the total length of the thread is 11/16".



A37472F	28-29	Fine thread 5/16" - 24	Price Ea.	\$ 4.65
A37472C	30-31	Coarse thread 5/16" - 18	Price Ea.	\$ 4.65

Open Car Top Loop Strap Bracket

This set of two chrome brackets with 4 chrome screws goes into the front corners of the top header bow on the Roadster.



A37500	28-31	Price Set/6	\$ 2.25
--------	-------	-------------	---------

Open Car Rear Window Frame Kit

Mike has a rear window frame for the open car in stainless steel complete with glass. 7" x 16 1/2" outside.



'28-'31 Roadsters & Phaetons.

The specified finishes for the inside steel frame are:

Deluxe Roadster & PhaetonSatin Golden Beryl
Standard Roadster & PhaetonSatin Black

A37639SS	28-31	Stainless - Outside only.	Price Set	\$ 165.00
----------	-------	---------------------------	-----------	-----------

Open Car Rear Window Frame Glass

If you need only the glass for the above frame, Mike has that, too!

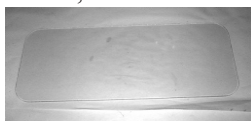

SEE PAGE OPEN 35 FOR MORE GLASS INFORMATION

A37644	28-31	Price Ea.	\$ 23.50
--------	-------	-----------	----------

Open Car Window Support

Mike also has this excellent reproduction of the 4 bumpers with screws that support the rear window when the top is down on your Roadster. 8 Pieces.

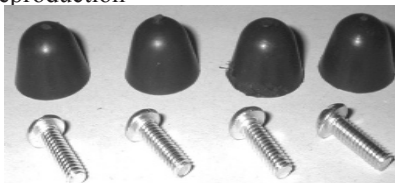

A42339	28-31	Price Set/8	\$ 2.95
--------	-------	-------------	---------

Open Car Roadster Top Hold Down Straps

For the Roadster Only. Mike has these leather top straps which hook onto the rumble grab handles to keep the top secure when you have it down. Set includes the hooks and brackets. Installation Instructions Included.



21" Long.

A42146A	28-31	Black. 28-29 Rdst,30-31 Std Rds	Price Pair	\$ 32.60
A42146B	30-31	Brown. Deluxe roadster	Price Pair	\$ 32.60

Roadster Pickup Top Straps - Fold Down Tops.

Designed for use with Lebaron Bonney folding top assemblies. Stainless Steel mounts, leather straps and mounting hardware included.



Available in Complete Sets Only

Only for Fold Down Tops.

PU352	28-29	Price Set	\$ 47.50
PU353	30-31	Price Set	\$ 47.50

Open Car Standard Phaeton Top Rest Set

Complete Top Rest Set, includes cast iron saddles, black leather pads, straps and studs. Please advise year of car for stud size.



7 Piece Set.

A37328A	28-29	Price Set	\$ 59.95
A37328B	30-31	Price Set	\$ 59.95

Open Car Phaeton Top Saddles

These are the saddles that mount onto the saddle studs (A37329 A or B).



A37339	28-31	Price Pair	\$ 19.95
A37330	1931 - Deluxe Phaeton	Price Pair	\$ 61.50

Mike's "A" FORD-ABLE Parts

Open Car Straps and Saddle Pads

Set of black leather straps and pads that fit into the saddles (A37339).



A37349 28-31 Price Pair \$ 15.25

Open Car Phaeton Top Saddle Studs

These studs screw into the rear of the Phaeton body for the saddles (A37339) to mount on. Need 2 per car.

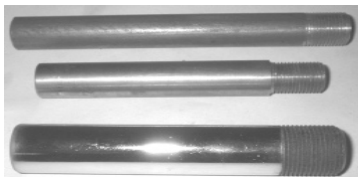

A37329A 28-29 Standard / 4 Door Price Ea. \$ 33.00
 A37329B 30-31 Standard / 4 Door Price Ea. \$ 33.00
 A37329C 30-31 Deluxe / 2 Door Price Pair \$ 22.95

Open Car Authentic Style Curtain Rods

These curtain rods are exactly like the originals in every detail. Phaeton Rear Doors use the same rods as the front - order 2 Pairs.



A41970D 30-31 Deluxe Roadster Price Pair \$ 37.95
 A41970A 28-29 Roadster Price Pair \$ 38.00
 A41970C 30-31 Std Roadster & Phaeton Price Pair \$ 39.00
 A41970B 28-29 Phaeton Price Pair \$ 38.00
 A41970E 30-31 Deluxe Phaeton Price Pair \$ 59.95

Open Car Standard Round Curtain Rods

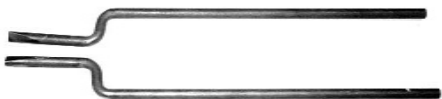

A180623 28-31 Std Roadster & Phaeton Price Pair \$ 26.95
 A180624 30-31 Deluxe Roadster Price Pair \$ 26.95

Curtain Rod Socket

This chrome curtain rod socket was used on the 1931 Deluxe 2 Door Phaeton - 180A.



A180620 31-32 Price Ea. \$ 8.45

Curtain Rod Support

Use this to support the top of the side curtain where the rod stops. Originally used on Deluxe Phaetons.



A180621 30-31 Price Pair \$ 15.00

Fitting and Fasteners for Side Curtains for a Roadster

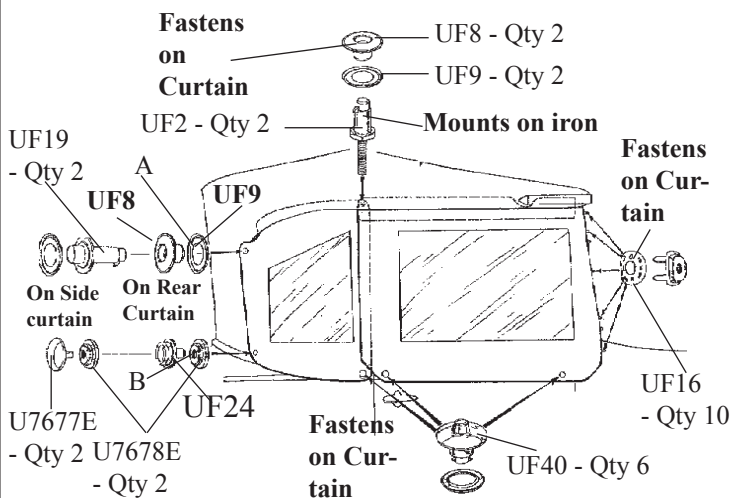

Fasteners A & B are Included with Top Kit - NOT Side Curtains.

For Side Curtain Fittings & Fasteners See Page Gen. 233

Fitting and Fasteners for Side Curtains for a Phaeton

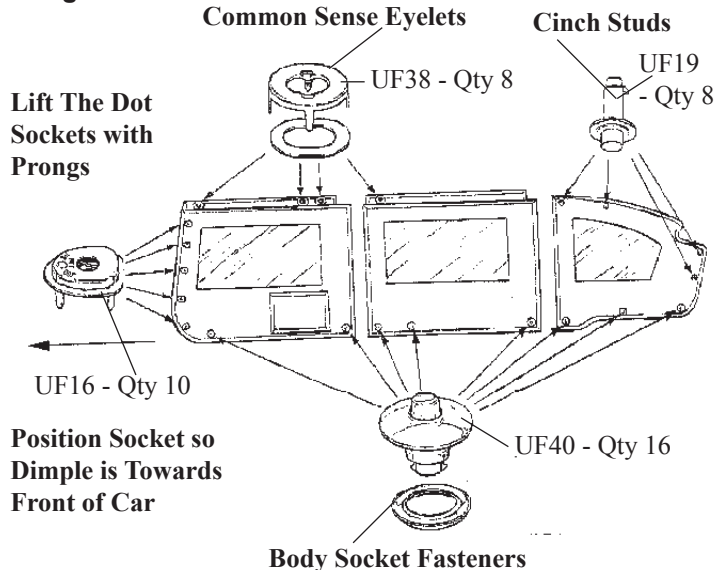

Mike's "A" FORD-ABLE Parts

Open Car Side Curtain Fasteners

The Male stud that attaches to the side curtain which locks into Body Sockets.



UF40 28-31 Price Ea. \$ 6.00

Open Car Side Curtain Fastener Tool

Use this tool to install the Side Curtain Fasteners (UF40).



UF40T 28-31 Price Set \$ 14.25

Lift the Dot Socket Tool

This is the Tool to install the UF16 - Lift the Dot Sockets with prongs. Punches a hole and 4 slits in the perfect location for mounting the Sockets.



UF16T 09-31 Price Ea. \$ 49.95

Open Car Body Sockets

These are the special sockets that fit into the body for the side curtains to snap into. The set has six sockets enough to do all cars **except** the **Phaeton**. Fits 7/16" hole. See Page Gen. 233 for more fittings.



A81002EA 28-31 Price Ea. \$ 1.70
A81002 Price Set \$ 10.00

Body Sockets Installation Tool

This is the tool for the A81002 Sockets.

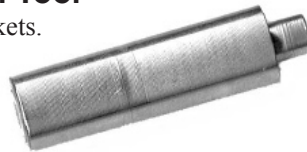

T81002T 28-31 Price Ea. \$ 1.50

FOR MORE INFORMATION ON FITTINGS & FASTENERS SEE PAGE Gen. 233 IN UPHOLSTERY SECTION.



1931 Deluxe Roadster owned by Mr. T Phillips showing a Top Boot and Door Edge Protectors.

Mike's "A" FORD-ABLE Parts

OPEN CAR DOOR HANDLES & PARTS

Door Edge Protector

Great idea to protect your door paint. Clips into studs that are usually used for side curtains. Used on all open cars. Available in Tan Canvas. Includes fasteners to be installed by customer. Soft napped backing

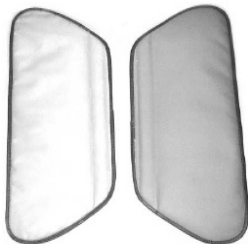

A35000 28-31 Price Pair \$ 45.00

Door Check Straps

These are nice light brown leather straps complete with chrome plates and mounting screws.



A702828S 28-31 Price Pair \$ 21.95

Open Car Door Hinge Sets

Sets of hinges for the open car doors. Each set has both upper and lower hinges for both sides of the car - Hinge Pin is included. In Aug. '30 till end, the bottom door hinge was changed from two mounting holes to three holes on the Cowl Post (lower) Hinge Only.

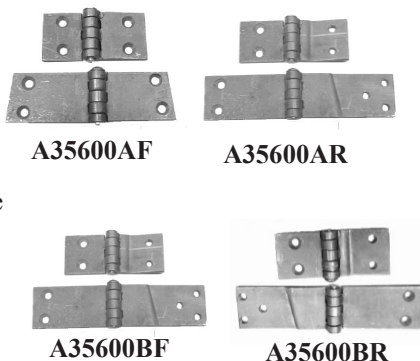

Front Door - Two Hole Hinge
A35600AF 28- July 30 Roadster & Standard Phaeton
Price Set/4 \$ 59.00

Front Door - Three Hole Hinge
A35600BF Aug 30-31 Roadster & Standard Phaeton
Price Set/4 \$ 59.95

Rear Doors
A35600AR 28-29 Standard Phaeton
Price Set/4 \$ 125.00

A35600BR 30-31 Standard Phaeton
Price Set/4 \$ 125.00

Open Car Hinge Pins

Mike has these authentic hinge pins for the Roadster and Phaeton.



A35615 28-31 Price Set 4 \$ 2.00

Hinge Pin Remover

This helpful tool, uses three graduating hardened push pins to push your old hinge pins up and out of the hinge. As you tighten the bolt it will push the dowel and the old pin out. Set comes complete with 3 different length push pins and complete instructions. **NOT** to be used on Slant Windshield Cars. **This item is NOT Refundable!!**
T46335HR 28-31 Price Ea. \$ 28.75

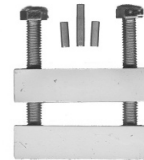

WARNING!!!

If your dowel pins start bending **DO NOT** go any further with this tool. These dowels are made from a hardened steel but **NOT** case hardened. The manufacturer has issued a warning that if a case hardened or heat treated steel was used, it could very well explode or splinter under such pressure, and possibly do bodily harm. I suggest trying penetrating oil, but if that doesn't work, then take a fine drill bit and try drilling at least halfway through the pin. Then use the removing tool.

Open Car Hinge Bolts

These are the hardware sets to attach the open car hinges. Each set contains 4 nuts, bolts, and washers. The DMB attaches door to hinge; the PMB attaches hinge to post. One Set does 1 Door.



A35600DMB 28-31 Price Set/16 \$ 2.85

A35600PMB 28-29 Price Set/12 \$ 2.00



Some Roadsters used 5/16" instead of 1/4".
Kit has 6 - 5/16-24 x 1/2" Flat Head Screws that mount the Door hinge to the door post. One set does 1 door.
A35600DMC 30-31 Price Set/6 \$ 2.00

Mike's "A" FORD-ABLE Parts

Open Car Bottom Door Seal

This is an 8 foot section of rubber to seal the bottom of the door. Please use A19009 if you have reproduction doors.



A19010 28-31 Price Ea. \$ 6.95

Stainless Open Car Handles

For the purist, these are very good stainless steel outside door handles.



A702350SS Oct. 28 - 31 Price Ea. \$ 28.95

Door Handle Screws

This is a set of four Stainless machine screws to attach the door handle.
4 x 10-32 x 11/16 Oval Head Screws.

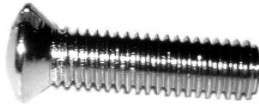

A702780MB 28-31 Price Set/4 \$ 1.25

Open Car Inside Door Opener

Chrome plated inside door handle.

Used on:

Oct 28 - 31 Phaetons & Roadsters

Includes one 10-32 x 1/2" Oval Head Stainless Screw.



A702400C 28-31 Price Ea. \$ 8.50

Open Car Door Handle Escutcheon Washer

Original size, Brass, Nickel Plated, with rubber anti-rattle washer.

October 1928 - 1931 Phaeton & Roadster. 2 Sets are needed for Phaetons.

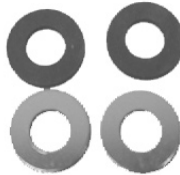

A47508 28-31 Price Set \$ 2.60

Open Car Door Handle Pads

This rubber pad fits between the door handle and the panel.



A702356A 28-31 Roadster Price Pair \$ 1.00
A702356G 28-31 Phaeton Price Set/4 \$ 1.60
A702356E 28-31 Rumble Price Ea. \$ 0.50

Open Car Deluxe Handle Escutcheon

The '30-'31 Deluxe Phaeton used this inside door handle escutcheon.
Chrome Plated.



A46270D 30-31 Price Ea. \$ 6.10

Open Car Upholstery Trim

One set of these metal trim pieces does both doors on the '28 models. Trim goes around the striker, the door opener, and the dovetail.

Instructions Included.



TA45320 1928 Price Set/6 \$ 11.25

1928 Open Car Door Latch

This is the latch used on the '28 Roadster/ Phaeton with no outside handle. For knob see A17261B. Paint Latch Body Color.



A35655AL 1928 Left Price Ea. \$ 19.00
A35655AR 1928 Right Price Ea. \$ 19.00

Open Car Inside Door Knob

This chrome-plated door knob is for the 1928 Roadster & Phaeton.



A17261B 1928 Price Ea. \$ 4.75

Open Car Door Latch

This style latch fits any of the '28-'31 Roadsters that do have outside handles. Paint Latch Body Color.

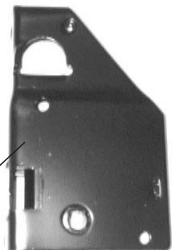

A35655ABL Oct '28 - 31 Left Price Ea. \$ 22.00
A35655ABR Oct '28 - 31 Right Price Ea. \$ 22.00

Mike's "A" FORD-ABLE Parts

Open Car Latch Screws

Only one set of these special flat-headed countersunk screws is needed to attach the latches to both doors.

Eight 10-32 x 1/2" Flat Headed Screws.
Paint Body Color.



A35655MB 28-31 Price Set/8 \$ 0.95

Open and Closed Car Dovetail

This two-hole male dovetail was used on the Roadsters & Phaetons.

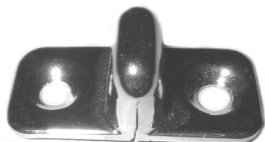

A76819A 28-31 Price Ea. \$ 3.75

Dovetail Screws

These machine screws hold the male dovetails in the door jams for all models.



A76819MB 28-31 Price Set/4 \$ 1.25

Dovetail Backing Plate

Dovetail Backing plate used on the 1928 - Early 1930 Roadster & Std. Phaeton.



RAR257 28- Early 30 Price Ea. \$ 6.25

6- Hole Male Dovetail

Chrome plated .
30-31 Deluxe Phaeton



A61419B 30-31 Price Ea. \$ 14.95

6 Hole Male Dovetail Screws

Nickel Plated Screws.

Use these screws for A61419A and A61419B.



A61419MB 28-31 Price Set/6 \$ 0.50

Interior Trim Screws

These sets of screws are exactly what is needed for each body style and year indicated.

#1005	28-29	Roadster	Price Set	\$ 7.95
#1006	30-31	Roadster	Price Set	\$ 7.95
#1015	28-29	Standard Phaeton	Price Set	\$ 11.25
#1016	30-31	Standard Phaeton	Price Set	\$ 11.25
#1017	30-31	Deluxe Phaeton (Two Door)	Price Set	\$ 11.25

Robertson Interior Trim Screw Kits

For all Canadian built cars.



CR1	1928AR	Phaeton	Price Set	\$ 11.80
CR2	1928AR	Roadster	Price Set	\$ 6.80
CR6	28-29	Phaeton	Price Set	\$ 11.80
CR10	30-31	Fordor Phaeton	Price Set	\$ 12.40
CR14	30-31	Roadster	Price Set	\$ 9.40

Door Bumpers

Mike has complete sets of the rubber, metal, and clips needed to change out the door bumpers for the following models.

The rubber may need trimming.

These are the best quality available.

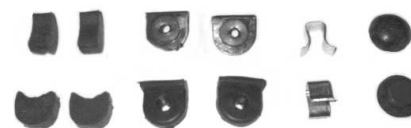

1928-1929 Roadster.	16 piece set.			
A702610ES	28-29	Price Set	\$ 8.95	
1930-1931 Roadster.	16 piece set.			
A702610FS	30-31	Price Set	\$ 9.25	
1928-1931 Phaeton.	34 piece set.			
A702610KS	28-31	Price Set	\$ 13.50	
Late 1931 4-door Phaeton.	22 piece set.			
A702610LS	1931	Price Set	\$ 12.50	
Late 1931 2 Door Indented Firewall Phaeton				
A702610MS	1931	Price Set	\$ 14.95	

Mike's "A" FORD-ABLE Parts

Door Bumper Dovetail Clip

This is the brass clip for the female dovetail on all Phaeton & Roadsters.



A702610C 28-31 Price Ea. \$ 1.75

Open Car Striker Plate

This striker plate goes on the door post and fits all the open cars except the Two Door (Deluxe) Phaeton.



A37505 28-31 Price Ea. \$ 6.00

Deluxe Phaeton Striker

This is the striker used only on the Deluxe Phaeton. It comes with special long screws. Strikers and hardware for both doors.

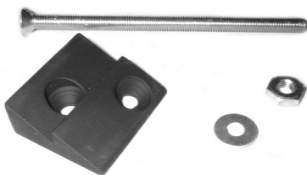

A37506 30-31 Price Pair \$ 49.95

Striker Mount Set

One set will be enough to attach the striker plate on both sides.



A37505MB 28-31 Price Set/4 \$ 1.50

See Page Open 40 for Curtain Rods and Sockets.



1931 Deluxe Roadster owned by Mr. D. Arquette.

Insulation

Firewall & Complete Car Insulation

If you tour in the heat of the summer (and who doesn't?), you'll want one of these insulators to keep engine heat out. It mounts inside the firewall and is molded to look like the firewall.



A18572A	28-29	Price Ea.	\$ 120.00
A18572B	1930 - 1931	Price Ea.	\$ 120.00
A18572C	1931 - Indented	Price Ea.	\$ 120.00

Complete Car Insulation

A multi - stage, automotive sound damping and insulation system for your Model A. Reduce engine and road noise, vibration and heat. This is the stuff that Henry Ford left out of original production and it makes all the difference in driving comfort! Should be able to install in approx. 2 hours. Complete instructions included. These are shipped directly from the manufacturer to you.

1928 - 1929 Roadster

A18815K	Complete Kit	Price Set	\$ 259.00
A18815A	Floor Kit	Price Set	\$ 89.00
A18815B	Trunk Kit	Price Set	\$ 49.00
A18815C	Body Panel Kit	Price Set	\$ 59.00
A18815D	Cowl Kit	Price Set	\$ 29.00
A18803	Door Damper Kit	Price Set	\$ 49.00

1928 - 1929 Phaeton

A18820K	Complete Kit	Price Set	\$ 389.00
A18820A	Floor Kit	Price Set	\$ 119.00
A18820B	Body Panel	Price Set	\$ 129.00
A18820C	Cowl Kit	Price Set	\$ 29.00
A18804	Door Damper Kit	Price Set	\$ 69.00

1930 - 1931 Roadster

A18855	Complete Kit	Price Set	\$ 259.00
A18855A	Floor Kit	Price Set	\$ 89.00
A18855B	Trunk Kit	Price Set	\$ 49.00
A18855C	Body Panel Kit	Price Set	\$ 59.00
A18855D	Cowl Kit	Price Set	\$ 29.00
A18803	Door Damper Kit	Price Set	\$ 49.00

1930 - 1931 Standard Phaeton

A18860	Complete Kit	Price Set	\$ 389.00
A18860A	Floor Kit	Price Set	\$ 119.00
A18860B	Body Panel Kit	Price Set	\$ 129.00
A18860C	Cowl Kit	Price Set	\$ 58.00
A18804	Door Damper Kit	Price Set	\$ 69.00

OPEN CARS

Mike's "A" FORD-ABLE Parts

Floorboards

For more Floorboard related items see page Gen. 93 in our Running Chassis section.

Floorboard Pedal Plates

This is the pedal plate specifically made for the **Deluxe Phaetons**. (Drop Steering Column). Order the **A35123FP** (below) as well.



A35123BR 1931 Price Set \$ 52.00

Floorboard Plate Mounting Screws

Use this set to attach the pedal plates (A35123BR).
 2 x 12/24 x 1/2" Machine Screws with #10 Oval Head
 1 #6 x 3/4" Oval Head Wood Screw and 3 Cup Washers.



A35123MB 28-31 Price Set/6 \$ 0.95

Floorboard Pedal Plate Felt Pad

This heavy felt pad fits tightly around the steering column and the pedals when used with the **A35123BR** metal plate.

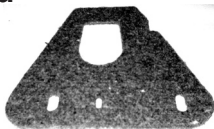

A35123FP 28-31 Price Ea. \$ 2.35

Floor Mats - Mats

Mike also has the mats available for the **Roadster Rumble & Phaeton Rear**.

See page **Gen. 94** for front floor mats.

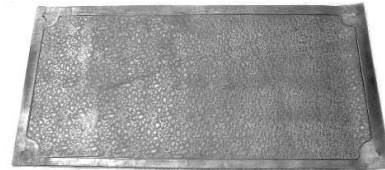

A2054 28-31 Rumble Price Ea \$ 29.50

A2056 28-31 Phaeton Price Ea \$ 71.00

Give Mike a call if Right Hand Drive Front Mats are needed - occasionally they are available!!

1929 Std. Roadster owned by Mr. F. Akers and restored at "Bentley's".



Gas Tank

Specifications:

Steel thickness: .049" to .051" (terne plated)
Capacity: 28-29, 10 gal.; 30-31, 11 gal.

The following new parts are required to complete a restoration of your Gas Tank. This is only a guide - do not assume that this is all that is needed, all other parts need to be thoroughly checked.

1. Gas Tank Sealer - AGTS
2. Fuel Tank Welt Anti-Squeak - A9006
3. Gas Tank Filler Screen - A9020
4. Fuel Shut Off - A9189A or B
5. Fuel Shut Off Filter - A9193T or A9194B
6. Filter in Gas Bowl - A9156
7. Gas Lines - A9230A, B, A9230AV, BV, A9240B, C
8. Gas Gauge Tool - T9300
9. Gas Gauge Rebuilding Kit - A9320S
10. Gas Gauge Nut - A9326 - Inner - A9330 - Outer
11. Intake and Exhaust Manifold Gaskets - A9433F, A9433, A9433C, A9433C2
12. Carb Kit - A9595Z, B or T
13. Grose Jet - A9564GJZ, GJT or B9564Z
14. Choke Rod Assembly - A9700B or C
15. Grommet Set - A9066A or A9715/17
16. Control Rods - A9740S
17. Sediment Bowl - A9155
18. Sediment Bowl Gaskets - A9173 or N

Gas Tank Sealer

Extend the life of your old tank with this semi-elastic sealant. Seals pin holes, covers rust flakes, not affected by alcohol. Cannot be shipped by air. For best results, have the gas tank chemically cleaned and rust free before using this sealer.



AGTS 28-31 Price Quart \$ 25.00

Gas Tank Etching

Remove light rust inside of your gas tank before you put in the AGTS Gas Tank Sealer. This will leave a gray phosphate coating. 16 Oz.



A9002E 28-31 Price Each \$ 11.75

Cowl Welt

This roll of 1/8" black beading is used when you mount your gas tank.

'28-'29 Across back edge of tank and down sides of cowl.

'30-'31 Around back edge and sides.

Paint lower body color.

A3405CW 28-31 10 Ft. Roll Price Roll \$ 3.75



Gas Tank Anti-Squeak Welt

This 1/16" x 12 ft. woven fabric welt is used as a buffer around the gas tank to eliminate rattles. The early models use it all the way around the tank; the later models on the front and back edges.



A9006 28-31 Price Roll \$ 3.60

Gas Tank Filler Screen

This tab-style screen sits in the neck of the gas tank. Does not fit early threaded style. See page 441 of Service Bulletins for correct installation.

These will **not** work with tool - T9021 - below.

A9020 28-31 Price Ea. \$ 10.45



Gas Tank Filler Screen Tool

A great tool to help with the installation or removal of the Filler Screen (A9020). Place the tool in the filler neck notches and use a socket wrench and extension.

For original Screens Only.

T9021 28-31 Price Ea. \$ 3.75

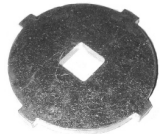

Gas Tank Protector

Lay this lined naugahyde on top of the tank when filling to protect your finish.

A9030P 28-31 Price Ea. \$ 21.95



Gas Tank Speedo Cable Grommet

This elongated grommet will help save your cable that runs under the gas tank in the tunnel to the speedo.

A9066R 28-29 Price Ea. \$ 3.45



Firewall to Gas Tank Screws

This set of screws has all the parts needed to attach the gas tank to the firewall.

Paint lower body color.

10 12-24 x 19/32 Pan Head Screw & Lockwasher.

#46 30-31 Price Set \$ 2.95



Mike's "A" FORD-ABLE Parts

Firewall to Gas Tank Bolts

This set of bolts is what you'll need to attach the gas tank to the firewall.

8 x 3/8 Tall Headed 1/4 - 20 5/8" Bolts, Lockwashers & 1/2" Nuts.

Paint lower body color.



#46A 28-29 Price Set/8 \$ 4.10

Gas Tank To Belt Rail Bolts

This set of bolts is what you'll need to attach the gas tank to the cowl. Bolts secure the back edge of the tank to the dash rail support.



#46B 28-29 1/4-20 x 1/2" Bolts, LW's & Hex Nuts Price Set/24 \$ 3.85



#46C Early 1930 12 x 1/4" - 20 3/4" Bolts & l.w. Price Set/36 \$ 3.85



#46D Mid 1930 Size changed to 5/16-24 x 25/32" Bolts, LW's and Nuts. Price Set/36 \$ 3.85



#46E Late 1930 to End - The same 5/16-24 x 25/32" Bolts were used, except the nuts were placed inside a cage. Unfortunately these cage nuts are no longer available. Price Set/24 \$ 4.85

Gas Cap

Vented gas cap in the style used for '28-'29 cars. Chrome over brass. Includes gasket.



A9030A 28-29 Price Ea. \$ 17.90

Show Quality Gas Cap

Vented stainless steel gas cap for '30-'31. This is the best quality available. It's a copy of the original Eaton style cap. These really fit. Includes the correct gasket.



A9030C 30-31 Price Ea. \$ 19.95

Gas Cap Gaskets

Treated leather gaskets.



A9035A 28-29 Price Ea. \$ 0.65



A9035 30-31 Price Ea. \$ 0.95

Sediment Bowl Repair Kit

Rebuild kit to improve the functioning of original cast iron sediment bulb on the firewall.

Instructions included.



A9155RK 28-31 Price Kit/3 \$ 4.75

Glass Sediment Bowl Micro Filter

Improve the efficiency with this filter which fits inside the glass bowl.

Instructions included.

Can only be used with A9155 - See Page Open 49.



A9156 28-31 Price Set/3 \$ 4.50

Sediment Bowl Screen

This brass screen fits between the bowl gasket and the bulb housing on the glass sediment bulbs.

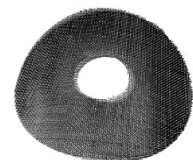

A9155SC 28-31 Price Ea. \$ 1.65

Sediment Bowl Assembly

Glass sediment bowl was originally an option from **Mid '29** but will work on all A's, except for indented firewalls. Gasket (**A9173** - below) and Screen (**A9155SC** - Page Open 48) are included. Use Micro Filter (**A9156** - Page Open 48) in this Bowl.



A9155 **28-31** **Price Ea.** \$ 26.95

Late '31 Filter Kit

Use this kit if you are NOT running the correct side-bowl style Zenith Carb. Designed to accommodate the late **1931** Model A's with the gas valve on the firewall. Includes a glass bowl type sediment bulb along with gas lines and fittings to install. The copper sediment bowl screen can be replaced by using **A9155SC**.

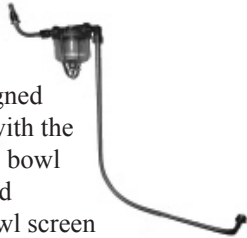

A9155L **1931** **Price Kit** \$ 27.95

Sediment Bowl Gaskets

For the glass sediment bowl. Neoprene should be replaced when you remove the bowl.



A9173 **28-31** **Cork** **Price Ea.** \$ 0.35



A9173N **28-31** **Neoprene** **Price Ea.** \$ 0.55

Sediment Bowl Glass

Replace your discolored bowl with a new clear one.



A9158 **28-31** **Price Ea.** \$ 5.50

Side Bowl Filter

On the **late '31** A's, Ford moved the filter to the side of the carburetor. Complete with all hardware.



A9161 **1931** **Price Set** \$ 51.00

Side Bowl Filter Without Hardware

If all you need is the side bowl filter, and not all of the hardware.



A9161A **1931** **Price Ea.** \$ 33.00

1928 to 1931 Cast Iron Sediment Bowl

7/8 - 14 Nut (1-1/4 Wrench) A9156A

Lock Washer

These three items are not available new.

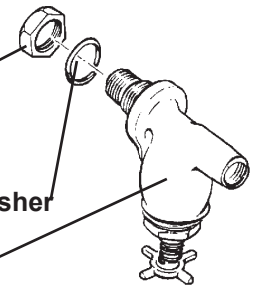

Mid 1929 to Early 1931 Glass Sediment Bowl

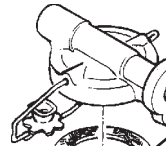

Cork / Neoprene Gasket - A9173 & N

Screen - A9155SC

Glass Bowl - A9158

Special Nut (No Lock Washer) - Not Available

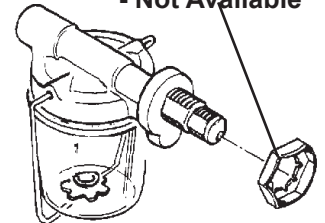

Thanks to Les Andrews for the use of his drawings.

Side-Bowl Rebuild Kit

With this you can rebuild your side bowl filter. Mounted on the side of the carb.



A9161SC **Late 1931** **Price Kit/3** \$ 2.25

Side Filter Bolt

This is the special bolt to hold the side bowl filter to the carb on the **late '31** A's.



A9161B **1931** **Price Ea.** \$ 4.60

Side Bowl Drain Valve and Spring

For the **late '31** A's, this drain needle with spring screws into the bottom of the filter.

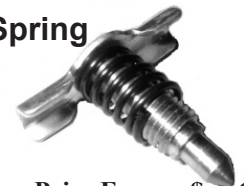

A9161V **1931** **Price Ea.** \$ 6.35

Sediment Bowl Brass Cap Plug

For Cast Iron bulbs. Goes into the bottom of the cast iron sediment bulb and **A9177** (Page Open 70) threads into it.



A9175 **28-31** **Price Ea.** \$ 8.50

Mike's "A" FORD-ABLE Parts

Sediment Bowl Brass Drain Valve & Forged Drain & Spring.

For Cast Iron bowls.



A9177 28-31 Price Set \$ 11.95

Installation of Repair Kit for Cast Iron Bowl

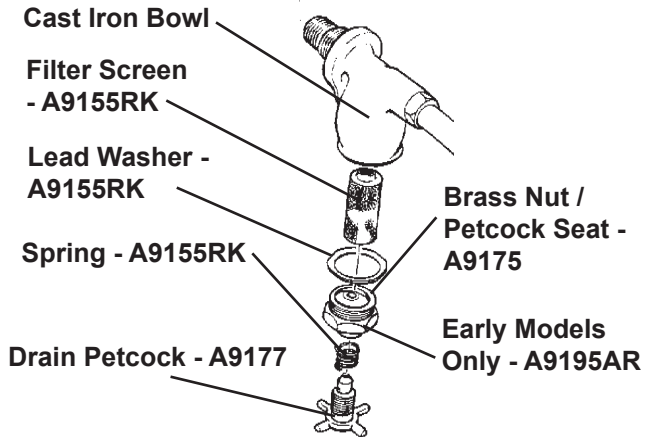

Fuel Shut off Valve

This all brass valve is inside the car to shut the gas off going to the carb.



A9189A 28-31 Price Ea. \$ 32.25

Fuel shut Off Valve Packing Nut

This brass nut holds the packing in place the sediment bulb.



A9195AR 1928 - late 1929 Price Ea. \$ 3.50
A9195B 1929-1931 Price Ea. \$ 2.50

Late '31 Gas Shut Off Valve

This all brass valve was used on the late '31 A's with the indented firewall. This is fitted onto the firewall in the engine compartment.



A9189B 1931 Price Ea. \$ 36.95

Electric Fuel Cut Off Don't Leave this off!!!!

How often have we forgotten to switch off the gas. Well now you don't have to, just leave your gas on and let the Electric Fuel Cut Off do the job for you. Made to go on your 1/4" fuel line that runs from the firewall to the carburetor. Simply Turn the key On or off - THAT'S IT. Comes with Complete instructions. Available in 6 or 12 Volt.



A9189 28-31 6 Volt Price Set \$ 55.00
A9189/12V 28-31 12 Volt Price Set \$ 55.00

Installation of Fuel Shut Off & Gas Tank Screen (A9193T) into A9189A

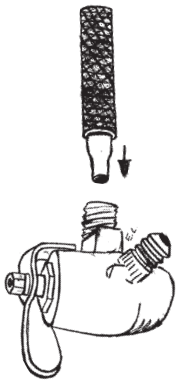

Gas Tank Screen (Fuel Shut Off)

This screen presses into the gas shut-off valve where it goes into the gas tank to keep sediment and rust out of the carb.



A9193T 28-31 Price Ea. \$ 3.15

Fuel Valve Grommet

For the late '31 valves that mount on the firewall, you'll need this excellent repro. to go in the hole.



A9171 1931 Price Ea. \$ 1.95

Gas Shut Off Fuel Valve Handle Only

Handle only for the earlier (A9189A) shut off valve.



A9189H 28-31 Price Ea. \$ 2.95

Gas Shut Off Fuel Valve Handle Only

This is the forged style handle used from the beginning until April 1929.



A9191A 28 - April 29 Price Ea. \$ 13.95

Gas Shut off Valve Packing

If your shut off valve isn't shutting off, try replacing the packing before buying a new valve.



A9193 28-31 Price Ea. \$ 0.95

OPEN CARS

Mike's "A" FORD-ABLE Parts

Gas Valve Repair Kit

Use this complete kit to rebuild the original style gas valve. Includes packing, jam nut, lock washer and gas resistant lubricant. Will also fit late '31's.



A9193S 28-31 Price Set/4 \$ 2.50

Inside Gas Lines

This line connects the gas valve under the gas tank to the sediment bowl on the firewall. 5/16" tubing.



A9230A 28-29 Price Ea. \$ 7.50

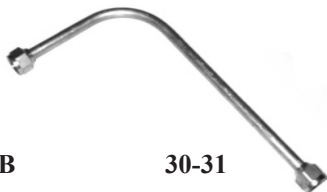

A9230B 30-31 Price Ea. \$ 6.75

Modern Gas Line Valve

If you are having continuous trouble with your gas line valve - we now have a modern valve in line - this guarantees a complete shut off with a quarter turn of the handle. Leave your A9189A or B in place then attach the A9230AV or BV

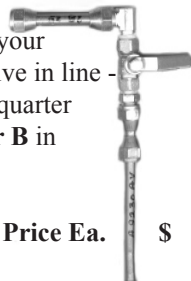

A9230AV 28-29 Price Ea. \$ 55.00

This is an excellent solution to a leaking gas problem.



A9230BV 30-31 Price Ea. \$ 55.00

Gas Line

This line with brass fittings connect the sediment bulb to the carb. Not for the late '31's A's.

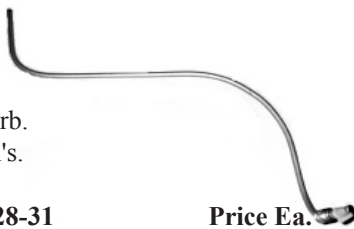

A9240B 28-31 Price Ea. \$ 4.50

For the late '31's with indented firewalls and side bowl carburetors. Includes Fittings.



A9240C 1931 Price Ea. \$ 4.60

Gas Line Fitting

Like the original brass gas line fittings.



A9243 28-31 Price Ea. \$ 1.50

Gas Line Fittings

Like the original 9/16 head fittings used on the late '31 A's. Set ferrule no more than 1/8" from the end of the tube.



A9243B 1931 Price Set \$ 2.80

Gas Tank Clamps

Hold the bottom of the gas tank stable with these. 5 per side needed for '28-'29; 2 per side needed for '30-'31.



A35266AR 28-29 10 Needed Price Ea. \$ 2.40

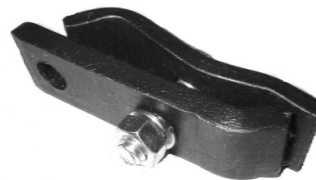

A35266BR 30-31 4 Needed Price Ea. \$ 2.40

Order Online Now and Save 5%

Visit our website for all your Model "A" needs.



www.mikes-afordable.com

OPEN CARS

Gas Gauge

Tool Set

Safely work on your gas gauge with this cast aluminum heat treated tool set. Will not damage nuts.



T9300 28-31 Price Set/2 \$ 6.45

Gas Gauge Assembly

Complete assembly
Inner and Outer Nut &
Gaskets.

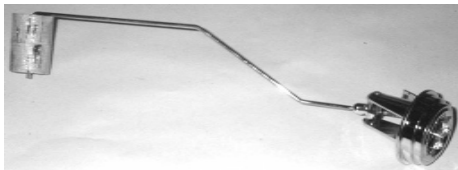

A9312D 28-31 Price Set \$ 36.30

Gas Gauge Assembly

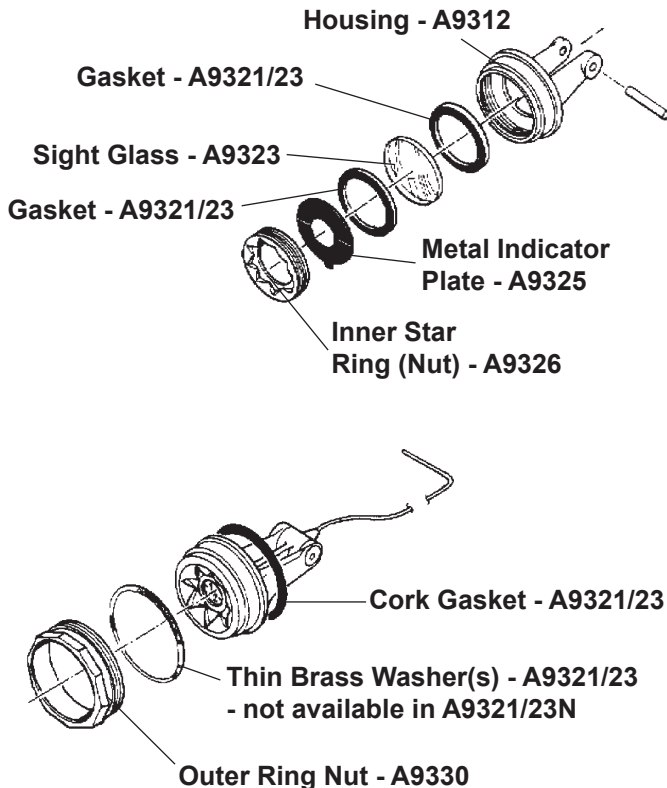

Thanks to Les Andrews for the use of his drawings.

Gas Gauge Rebuilding Set

This set includes cork gaskets, lens, face plate and cork float. The order is gasket, glass, gasket, face plate, inner nut. Large gasket against tank, gas gauge assembly, brass washer & outer nut.

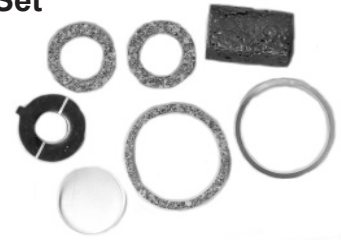

A9320S 28-31 Price Set/9 \$ 5.95

Gas Gauge Cork Float Only

You can buy this cork float separately if its all you need. Treated to resist gas.



A9312F 28-31 Price Ea. \$ 1.95

Gas Gauge Neoprene Float

You can now get a Gas and Alcohol proof float to eliminate the problem of having your cork float disintegrate over time in the gas.



A9313B 28-31 Price Ea. \$ 4.45

Gas Gauge Brass Float

Modern style gas float based on the design of a carburetor float. You should never have any trouble with this.



A9313C 28-31 Price Ea. \$ 9.95

Gas Gauge Gaskets

Choose between cork like Ford used or modern neoprene.

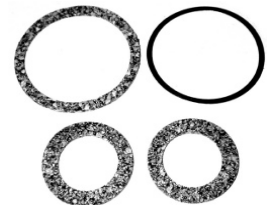

A9321-23 28-31 Cork Price Set/4 \$ 1.25

A9321-23N 28-31 Neoprene Price Set/4 \$ 1.75

Gas Gauge Lens

Glass lens.

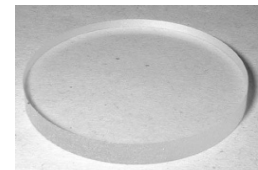

A9323 28-31 Price Ea. \$ 0.95

Gas Gauge Face Plate

Like the original.

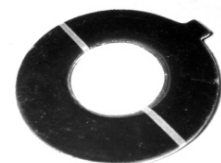

A9325 28-31 Price Ea. \$ 2.10

Mike's "A" FORD-ABLE Parts

Gas Gauge Inner Nut

Chrome Finished inner nut for the "A" gas gauge.



A9326 28-31

Price Ea. \$ 6.55

Gas Gauge Outer Nut

Chrome finished outer nut for the "A" gas gauge.



A9330 28-31

Price Ea. \$ 6.75

"B" Fuel Pump Rebuild Kit

A complete rebuild kit for your '32-'34 4 cy. fuel pump.

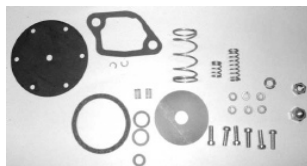

B9349A 32-34

Price Set \$ 39.95

"B" Fuel Pump Gasket

This gasket goes between the block and the fuel pump on a "B" 4 cyl. engine.



B9374 32-34

Price Ea. \$ 1.00

"B" Fuel Pump Diaphragm

Included in the B9349A kit.

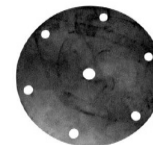

B9390 32-34

Price Ea. \$ 5.00



1930 RHD Standard Phaeton owned by Mr. G. Rae in South Africa.

Speedometer

Speedometer Mount Set

This set of 2 screws, nuts, and lock washers is used to mount your speedometer to the instrument panel.



A17255MB 28-31 2 x 1/4" - 20 x 1/2" screws + 1/2" square nut & lock washer
Price Set/4 \$ 0.80

Rebuilt Speedometers

Sold on **EXCHANGE ONLY.** Mike must have your complete re-buildable core to ship a rebuilt one out.
NO OUTRIGHT SALES.
NO EXCEPTIONS.



Only Stewart Warner Speedometers are still being rebuilt.

A17255AS 28-30 Oval face Price Ea. \$ 225.95
A17255BS 30-31 Round face Price Ea. \$ 225.95

Speedometer Bezel Rim - Nickel

Shiny new face plate to replace that cracked or broken plate.



A17259A 28-30 Oval S/W Price Ea. \$ 19.95
A17259C June '30-31 Round S/W Price Ea. \$ 16.75
A17259D June '30-31 Round Waltham Price Ea. \$ 16.95

Speedometer Lens

If your old glass lens has gotten scratched or dingy over the years, replace it with one of these.

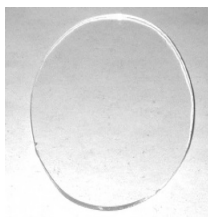

A17256AR Oval Price Ea. \$ 1.10
A17256B Round Price Ea. \$ 1.00

Speedometer Lens Gaskets

Mike also has new gaskets for the speedometer lens.

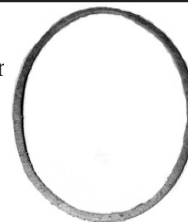

A17257AR 1928 - June '30 Oval face Price Pair \$ 1.15
A17257B July '30 - 1931 Round face Price Pair \$ 1.15

Speedometer Lens Retainer

This ring holds the lens into the chrome face for the round speedometer.

Sorry not available for Oval Lenses.



A17258B 30-31 Price Ea. \$ 3.25

Speedometer Face Plate

This is the black plate that fits behind the chrome facing on the Speedometer.

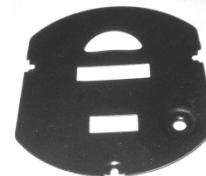

A17268A 28 - June 30 Oval speedo Price Ea. \$ 6.20
A17268C June 30 - 1931 Rnd Stewart Warner Price Ea. \$ 6.80
A17268D June 30 - 1931 Round Waltham Price Ea. \$ 7.85

Speedometer Decals

Replace your tired number decal with the right new one.



A17255A '28- June '30 Oval Faces Speedo Price Ea. \$ 2.75
A17255B July '30-31 Round Faced Stewart Warner - 7/8" Wheel Price Ea. \$ 2.75
A17255C July '30-31 Round Faced Waltham - 3/4" Wheel Price Ea. \$ 2.75
A17255D July '30-31 Round Faced Northeast Price Ea. \$ 3.00

Speedometer Calibration by Wiley Higgins

While driving a Model A, the optimum driving speed is a steady 45 MPH. This speed moves you along at a good pace and helps keep you out of the way of most traffic, while not putting too much strain on your engine. If your Model A won't hold a steady 45 M.p.h., something needs to be corrected.

First of all, a Model A Speedometer usually is *not accurate* after over 60 years of use, even it has been rebuilt by a professional. Also, tire size and rear-end ratio have an effect. So, your speedometer may indicate a different speed than you are actually travelling down the road - either faster or slower.

The best method of determining the **actual speed** you are travelling is to **conduct a time/distance check**. Here's how:

1. Select a reasonably **straight and level stretch** of highway.
2. Use your digital or sweep second hand watch as a stop watch.
3. As you pass any **mile post** (remember, straight and level is best), start the stop watch or note the seconds on the sweep second hand.
4. **Hold the same, steady speed for one mile** to the *next* mile post, and **note how many seconds have elapsed**.
5. **Consult the chart** below to determine your true speed over the ground.
6. **Repeat steps 1. through 5.** above two or three times and **get an average**.
7. Adjust your speed over the ground slower or faster if you have a speedometer error to hold a steady 45 M.p.h.. For example, it takes **80 seconds** to go **1 mile** if your *true* ground speed is **45 M.p.h.**

SEC (1 Mile)	MPH	SEC (1 Mile)	MPH
102	35.3	86	41.9
101	35.6	85	42.4
100	36.0	84	42.9
99	36.4	83	43.4
98	36.7	82	43.9
97	37.1	81	44.4
96	37.5	80	45.0
95	37.9	79	45.6
94	38.3	78	46.2
93	38.7	77	46.8
92	39.1	76	47.4
91	39.6	75	48.0
90	40.0	74	48.7
89	40.5	73	49.3
88	40.9	72	50.0
87	41.4		



A17270A, B or C



A17275

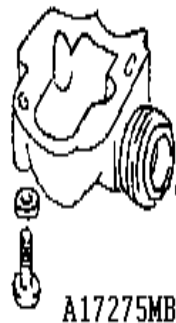

A17271A, B, C or D

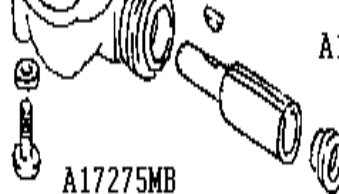

A17273S or R

A17275MB

A17274A or B

Speedometer Trip Stem

Nickel plated, knurled stem that pulls out on the Oval Speedo to set the odometer. Complete stem assembly with gear and retaining washer.



A17267 28 - Mid 1930 Price Set \$ 20.00

Speedometer Grommet

This speedometer grommet fits in the firewall for the cable to go through, next to the choke rod.



A14567 28-31 Price Ea. \$ 0.75

Gas Tank Speedometer Cable Grommet

This elongated grommet will help save your cable that runs under the gas tank in the tunnel to the speedo.



A9066R 28-29 Price Ea. \$ 3.45

OPEN CARS

Mike's "A" FORD-ABLE Parts

Water Inlet - Speedo Cable & Cut-out Wire Clip

This wire clip was used in several places by Ford: for the water inlet and speedometer cable inside the firewall for all years; for the cutout wire on the firewall in 30-31.



A14577A 28-31

Price Ea. \$ 1.50

Firewall Wire Clip Bolt (Round)

This is the correct round head screw with lock washer to attach the wire clip to the firewall.

Paint Black. Use with A14577A & B - Page Gen. 196.

A14577BR 28-31 12/24" x 1/2" screw & l.w.



Price Set/2 \$ 0.40

Speedometer Cables

Due to the fact that there are several manufacturers of interior cables and they are all being reproduced in different lengths, thereby causing a lot of confusion and problems we are no longer stock inner cables seperatly.

Replace your worn out speedometer cable with one of these new complete assemblies with steel ends. Mike's note: The early Ford cable was 1/2" in diameter while the latter was 1/4".

The early gear on the drive shaft key has a round cable end with key up. The '30-'31 accepts the square cable.



Speedo End Square - Drive end Keyed
A17260AU 1928 - June '30

USA (oval)
Price Ea. \$ 33.95

Speedo End Square - Drive end Square
A17260B July '30 - 31

USA (round)
Price Ea. \$ 26.95

Black Vinyl Covered Speedometer Cable

An inexpensive alternative to the original flexible cables. For the round speedometer.



A17260C 30 - 31

Price Ea. \$ 15.00

Speedometer Lube

If your cable is OK but not turning smoothly, get this 7cc packet of graphite lubricant.



A17260L 28-?

Price Ea. \$ 2.95

Speedometer Support Clip

This support clip with mounting hardware goes on the frame rail to hold the speedometer cable.

5/16-24 x 11/16 Bolt, Lockwasher and Nut



A17265A 28-30 Oval speedo -

Price Ea. \$ 2.75

A17265B 30-31 Round speedo

Price Ea. \$ 2.75

Speedometer Drive Gears Only

Mike also has the drive gears available for both the 3.54 and 3.78 rear end gears.



A17270A 28-29 19 Tooth Gear used with 21" and 19" Tires

Price Ea. \$ 14.60



A17270B 30-31 18 Tooth Gear used 19" Tires

Price Ea. \$ 12.25

Extra High Speed Drive Gear

This gear goes in the speedo drive assembly that bolts to the bottom of the torque tube.

This is a high strength plastic 17 tooth gear that is used with the A4209XHS. See Page Gen. 84.



A17270C 28-31 3:27 Ratio - 17 Tooth

Price Ea. \$ 29.95

Speedometer Housing Only

New Housings are now available.

Replace your worn housing with a new one.



A17271 28-31

Price Ea. \$ 41.00

Speedometer Housing and Gear Assembly.

A complete new housing and gear assembly have been made from the FORD blue print. Includes gear, shaft and retainer. Order Gasket A17275 Separately.



- | | |
|---------|--|
| A17271A | 1928 - June 1930 - Standard Gear with Round Hole Shaft for 21" Tire
Price Ea. \$ 56.95 |
| A17271B | June 1930 - 1931 - Standard Gear with Square Hole Shaft for 19" Tire
Price Ea. \$ 56.95 |
| A17271C | 1928 - June 1930 - High Gear with Round Hole Shaft for 21" Tire
Price Ea. \$ 56.95 |
| A17271D | June 1930 - 1931 - High Gear with Square Hole Shaft for 19" Tire
Price Ea. \$ 56.95 |



A17270A, B or C



A17275

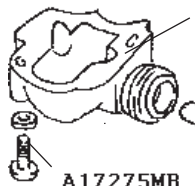

A17271A, B, C or D

A17273S or R

A17275MB

A17274A or B

Speedometer Gasket

Here's a gasket to get the proper gear mesh on the gear case.



- | | | |
|--------|-------|-------------------|
| A17275 | 28-31 | Price Ea. \$ 0.50 |
|--------|-------|-------------------|

Speedometer Gear and Case Mount Bolts

Mike has this set of two fine-threaded bolts with lockwashers to bolt the speedometer gear and case to the torque tube.



- | | | |
|----------|-------|--|
| A17275MB | 28-31 | 2 x 1/4" - 28 x 1" bolts & l.w.
Price Set/4 \$ 0.60 |
|----------|-------|--|

Speedometer Drive Gear Shaft

The end of the speedometer cable slides into this shaft in the gear/case assembly that bolts to the torque tube. Square end (S) and Round end (R) available.



- | | |
|---------|--|
| A17273R | 1928 - June '30
Round ended cable / Oval Speedo
Price Ea. \$ 12.95 |
|---------|--|



- | | |
|---------|---|
| A17273S | July '30 - '31
Square ended cable / Round Speedo
Price Ea. \$ 12.95 |
|---------|---|

Speedometer Shaft Retainer

This retainer goes into the threaded end of the gear and case to prevent the shaft from coming out.



- | | |
|---------|---|
| A17274A | 28 - July '30 - Short Retainer
Price Ea. \$ 1.40 |
|---------|---|



- | | |
|---------|--|
| A17274B | July '30 - 1931 - Longer Retainer
Price Ea. \$ 1.40 |
|---------|--|

Speedometer Snap Ring

This snap ring holds the speedometer drive gear and thrust washer in place on the drive shaft.



- | | |
|--------|----------------------------|
| A17286 | 28-37
Price Ea. \$ 0.75 |
|--------|----------------------------|

Speedometer Thrust Washer

The thrust washer goes onto the drive shaft between the bearing and the speedometer drive gear.



- | | |
|--------|----------------------------|
| A17290 | 28-48
Price Ea. \$ 1.95 |
|--------|----------------------------|

OPEN CARS

Mirror

Rear View Mirror Mount Screws

This set of 3 chromed oval headed wood screws is used to mount the rear view mirror to the wooden header.

3 x #10 x 1" Oval Head Screw.



A17681BMB

30-31

Price Set/3 \$ 1.00

Inside Rear View Mirror Bracket Clip

These are the clips that hold the glass in place.



RAR252

Price \$ 4.95

Roadster & Phaeton Open Car Mirror

This mirror with frame is for the '28-'29 Roadster & Phaeton.



A17681AS

28-29 Black

Price Ea. \$ 21.95

Open Car Mirror

Mike has the stainless steel mirrors for the '30-'31 Open Car.

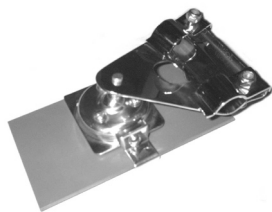

Open car.

A17681SS

30-31 Stainless

Price Ea. \$ 30.25

Rear View Mirror Glass

If your mirror is cloudy or the plating has worn off, replace it with one of these quality beveled mirrors. The smaller is correct but the larger gives better visibility.



A17704

Original Size - 2-1/2" x 4 1/2"

Price Ea. \$ 5.50

A17704B

2-1/2" x 6"

Price Ea. \$ 6.50

1928-1929 Open Car Post Mirror

This screws into the screw hole that holds the windshield stanchion to the body of the '28-'29 Open Cars. 5/16 - 24 Thread.

You must drill and tap for the '28-'29.

AR17700P

28-29 4" Glass



Price Ea. \$ 38.45

1930-1931 Open Car Post Mirror

This mounts on the flat area about halfway up the driver side stanchion on the '30-'31 Deluxe Open Cars. 7/16 - 20 Thread.

B17700P

30-31

Price Ea. \$ 38.45



Sidemount Mirror

This style sidemount mirror is attached with a leather strap.

B17700SM

Price Ea. \$ 47.30



Open Car Windwing Mirror

This stainless mirror clamps to the windwing glass.

Ideal for Roadsters & Phaetons.

B17700WSS

28-31

Price Ea. \$ 27.50



Clock Mirrors

Mirror clocks are designed especially for the Model A Fords. Two of the outstanding features found in each Clock Mirror are the beautiful beveled quality mirror along with the accurate and dependable Quartz timepiece with its Arabic or Roman Numeral dial reflecting styles of the past. Comes with a 2 year manufacturer warranty. Please make sure that your bracket will adjust to hold a 2" high mirror. Shown on a bracket - this is NOT included.



A17705AS

Silver Arabic

A17705AG

Gold Arabic

A17705RS

Silver Roman Numeral

A17705RG

Gold Roman Numeral

Price Ea. \$ 95.00

Mike's "A" FORD-ABLE Parts

Clock Mirror with Polished Edge

A beautiful replacement clock mirror with a polished edge. The mirror is not glass.



A17706

28-31

Price Ea. \$ 39.95

Mr. W. T Higgins to many known as "The Colonel" shared some wonderful memories with us.



My father is the one on the left in the pic with the three men with the roadster in the background. I expect the pic was made around 1935 or so. It was made in front of my grandfather's house. The other two men worked on my grandfather's farm.



The other one of the roadster by itself was probably made around 1936. The car had been sitting in the barn, up on blocks, because my father couldn't afford to run it during the great Depression. He ordered 4 tires from Sears and Roebuck, which were delivered one tire at a time by the rural mail carrier, and got the car out of the barn around '36, and mounted them. He later took a brush and repainted it black. He then sold it to one of his brothers, who later sold it again.

I remember my father telling about seeing it later in a nearby town, with the rumble seat removed and a makeshift "pickup" bed installed. Times were still hard in '36 and the owner was peddling stove wood from door to door to make a little money. We never saw it again.

My father and mother courted in the car. In the local lingo, they called it "sparking" -- don't ask me why. They were riding around on Sunday, April 13, 1930, with two of his sisters in the rumble seat. He leaned over and whispered, "Let's take the girls home and go over to Iuka and get married". She agreed and they drove across the Tennessee River to Iuka, Mississippi, and got married. Alabama had a 3-day waiting period once you registered to get married, so they hurried up the process by going to Mississippi. Their marriage license is attached.

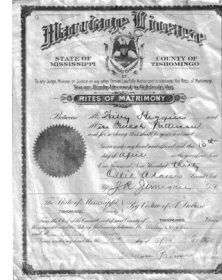

My last memory of the car was riding in it with my uncle. In that area of rural Alabama there were springs up on the hillsides and the water simply ran across the road -- no bridges. They were shallow and you could drive thru the little streams easily. The car needed a wash job, so my uncle pulled off the road into the stream and began to wash it. I can distinctly remember he played a trick on me by throwing a bucket of water at the windshield while I was still in the car to make me jump.



I also found this picture. My mother gave it to me after she found it in a trunk belonging to my Aunt Mary, whom we called Sis, after she died in 1982. Sis is the fourth lady from the left, with the white collar. My mother didn't know who the Model A belonged to.

The others in the pic are relatives and friends. The man in the pic is distant cousin Lem Dodson. I wrote him several years ago when he was in his 90's, sent him a copy of this pic and asked him if he knew who the car belonged to. He didn't remember who owned it and added, "I never owned a Ford in my life!!". The first lady on the left is his sister, Flora May.

I think the car is a late 1928 or an early 1929. It has a drum tail light and fluted headlight lenses, but door handles, which '28's didn't have. The hood louvers appear to be '29 style, i. e., getting longer as they go back. The '28's were all the same length. Also, the front bumper center bumper clamp is missing. Probably shook off on the rough roads back then.

Cowl Light

The following new parts are required to complete a restoration of your Cowl lights. This is only a guide - do not assume that this is all that is needed, all other parts need to be thoroughly checked.

1. Bulbs - A13466
2. Arms - A13301AR or BS
3. Screw Set - A13302BT
4. Mounting Plate - A13303
5. Mounting Plate Rivet - A13307
6. Rim Tab - A13305
7. Lens - A13308AR, D or DA
8. Gaskets - A13309A or C
9. Mounting Bolts - A13327
10. Pigtails - A13412
11. Sockets - A13338
12. Reflectors - A13315C
13. Rim Retainer Clips - A13316S
14. Cross Over Wire - A13302XO

Cowl Lights Arm Position Template

Drivers Side - 1930 - 31 Cowl Lights

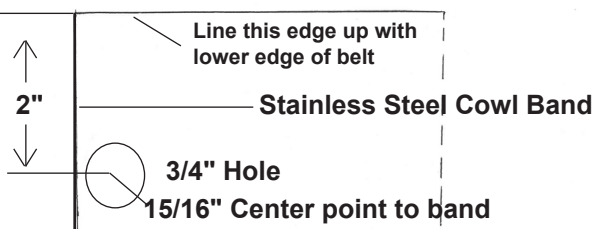

Passenger Side - 1930 - 31 Cowl Lights



Cowl Lights

Beautiful reproductions! The '28-'29's are chrome and the '30-'31's are stainless with chrome arms.



A13302AR	28-29		Price Pair	\$ 165.00
A13302ES	30-31		Price Pair	\$ 135.00
A13302ARTS	28-29	6V w/turn signal	Price Pair	\$ 175.00
A13302ESTS	30-31	6V w/turn signal	Price Pair	\$ 155.00

Tail Light, Parking Light, Cowl & Instrument Panel Light Bulb

3 Candle Power as original.
10 Candle Power is available if you would prefer a brighter bulb.

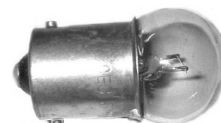

A13466/3	3 CP	Price Ea.	\$ 0.90
A13466/10	10 CP	Price Ea.	\$ 1.25

Tail Light & Parking Quartz Bulbs

If you want a lot more light, use these direct replacements for your original bulbs. These are also known as "Ugly Bulbs".

Will not work with sealed beam or halogen headlights.



Tail Light and Parking: 50/20 Watt

B13466Q6	6 Volt	Price Ea.	\$ 13.75
B13466Q12	12 Volt	Price Ea.	\$ 11.00

Cowl Light Turn Signal Conversion Kit

This kit can convert both cowl lights to turn signals. It uses a double-filament bulb so it can be used as a parking light as well.



A13303TSAR	28-29	6V	Price Set	\$ 44.95
A13303TS	30-31	6V	Price Set	\$ 44.95
A13303TSBR	28-29	12V	Price Set	\$ 44.95
A13303TSB	30-31	12V	Price Set	\$ 44.95

Mike's "A" FORD-ABLE Parts

Cowl Light Turn Signal Bulb Only

The turn signal kit uses this double filament bulb. Offset tabs.



A13304/6	6 Volt	Price Ea.	\$ 2.10
A13304/12	12 Volt	Price Ea.	\$ 2.10

1928-1929 Cowl Light Arms

These chrome plated cowl light arms may be all you need if your light buckets are still in good shape.



A13301AR	28-29	Price Pair	\$ 75.00
----------	-------	------------	----------

1930-1931 Cowl Light Arms

Good chrome-plated arms for the '30-'31 cowl lights.



A13301BS	30-31	Price Pair	\$ 87.95
----------	-------	------------	----------

Cowl Light Arm Mounting Plate

This plate fits inside the bucket that the arm mounting screws go into.

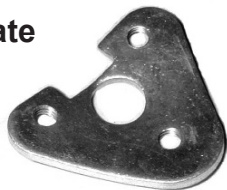

A13303	30-31	Price Ea.	\$ 3.05
--------	-------	-----------	---------

Cowl Light Arm Mounting Plate Rivet

This tubular rivet holds both the Mounting Plate (A13303) and the Rim Tab (A13305) to the bucket.



A13307	30-32	Price Ea.	\$ 0.60
--------	-------	-----------	---------

Cowl Light Mount Bracket

You'll need these brackets for inside the cowl section if you're installing cowl lights on your "A".

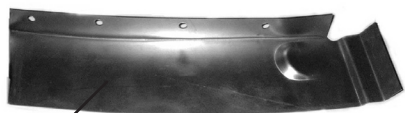

A13300BR	28-29	Price Pair	\$ 48.00
A13300BB	30-31	Price Pair	\$ 46.00

Cowl Light Marking Tool

This little tool takes the guesswork out of deciding where to drill new holes when installing a cowl light.

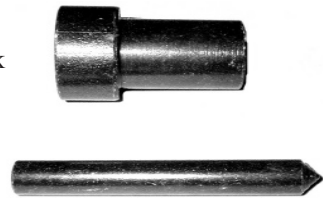

T13300X	28-31	Price Set	\$ 4.25
---------	-------	-----------	---------

Cowl & Tail Light Visor

Match up your cowl lights with a visor set. Just like the headlight set. See page Gen. 185 for Headlight visors.



A13001A	28-31	W/Jewel	Price Pair	\$ 23.00
---------	-------	---------	------------	----------

Cowl Light Rims

Highly Polished Stainless Steel rim.



A13306AR	28-29	Price Ea.	\$ 14.00
A13306B	30-31	Price Ea.	\$ 14.00

Cowl Light Rim Retainer Clips

This set of retainer clips will hold the lens to the rim for both your '30-'31 cowl lights.



A13316S	30-31	Price Set / 4	\$ 1.15
---------	-------	---------------	---------

Cowl Light Rim Tab

The rim screw goes into this small tab.



A13305	30-31	Price Ea.	\$ 2.55
--------	-------	-----------	---------

Cowl Light Lens

Clear lens.

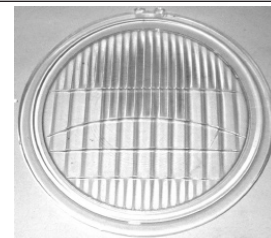

A13308AR	28-29	Price Ea.	\$ 6.55
A13308D	30-31	Price Ea.	\$ 4.35

Mike's "A" FORD-ABLE Parts

Amber Cowl Light Lens

If you've converted to a turn signal, these amber lenses will show up better.



A13308DA 30-31 Price Ea. \$ 6.75

Lens Gaskets

Replace yours to keep moisture out, extend the life of the bulb.

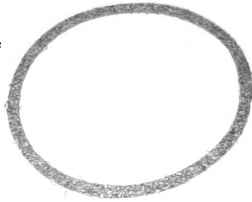

A13309A 28-29 Price Pair \$ 1.15
 A13309C 30-31 Price Pair \$ 1.15

Cowl Light Reflector

This nice chrome reflector with bulb socket fits the '28-'29 cowl lights.



A13315AR 28-29 Price Ea. \$ 14.95

Cowl Light Reflector

Brand new, well polished reflectors for your '30-'31 cowl lamps.



A13315C 30-31 Price Ea. \$ 14.95

Cowl Light Screw Set

Stainless screws with lock washers to attach the cowl light to the cowl light bucket. 14 Piece Set. 6 x 10/32 x 1/2" & Washers



A13302BT 30-31 Price Set/14 \$ 2.00

Cowl Light Socket

Replacement socket for the '30-'31 cowl light bulb. Has the rivet, but no wire pigtail.



A13338 30-31 Price Set \$ 3.75

A13339 Rivet only Price Ea. \$ 0.50

Cowl Light Cross Over Wire

This wire connects the two cowl and runs a single wire to the wiring harness.

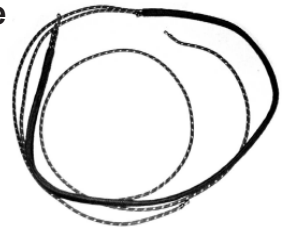

A13302XO 28-34 Price Ea. \$ 8.25

Cowl Light Wire Connector

This special ceramic connector was located at the base of the steering column to connect the cross over wire to the harness.



A13302C 28-31 Price Set \$ 7.95

Cowl Light Wood Blocks

These were used in '30-'31 to prevent denting. They fit between the cowl panel and the brace that the arm bolt goes through.



A13318 30-31 Price Pair \$ 3.95

Cowl Light Mount Bolt

This bolt has a hole through it for the cowl wire to go through. It mounts the light to the body.



A13327 30-31 Price Ea. \$ 1.25

Cowl Light Grommets

These grommets were used for '28-'29 only and go where the arms go through the panels.



A13324R 28-29 Price Pair \$ 3.80

Cowl Light Pigtails

Yellow with black tracer like the original, this wire goes through the socket and out the arm.



A13412 28-34 Price Pair \$ 3.50

Cowl Light Wire Supports

You'll need three of these to hold the cowl light cross over wire inside the firewall.

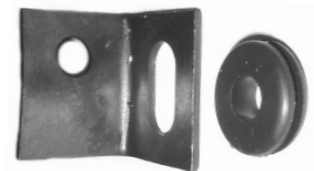

A14593 30-31 Price Set \$ 2.90

Mike's "A" FORD-ABLE Parts

Cowl Light Wire Support

Or you can use three of these to hold the wires for the cowl lights and the wipers.

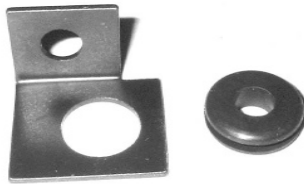

A14593A 28-29 Price Ea. \$ 2.25

Turn Signal Kit (6 Volt)

BE SAFE. Signal Stat. Add this complete turn signal kit directly to your tail lights. Kit includes the switch, fuse, flasher, flasher socket and complete instructions. Cowl conversion kit works with this one. If you do not have cowl lights you will need to install front turn signal lights of some sort. Comes with instructions. 11 Piece Set. For more turn signals items see our Turn Signal Section on **Page Open 70**.



A13310A 28-31 Price Set/11 \$ 58.95

Turn Signal Flasher

6-Volt flashers are hard to find; you'll need this if you have added turn signals to your A.



A13311 28-31 Price Ea. \$ 5.25

Complete Turn Signal Kit (6 or 12 Volt + or -)

Now you can have super bright Amber LED turn signals for your "A"! Kit includes super bright LED turn signals, stainless steel brackets, controller and wire. The easy hookup connects to 6 Volt OR 12 Volt cars with negative or positive ground without even flipping a switch. The kit features all solid state components (there are no turn signal flashers to wear out and the LED's will last for over 25 years!). The whole kit is bolted on so you don't have to permanently modify your car. Slim line turn signals mount to bumper clamp bolts and have a one wire hook up. Each turn signal is individually short circuit protected so if one wire shorts to the chassis, only that one light won't come on. Eliminate the short and the turn signal will work again. Also has a hazard light function and is backed by a one year manufacturer's warranty. 20 Piece Set.

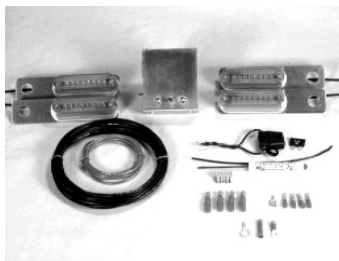

A13311A 28-31 Price Kit/20 \$ 169.95

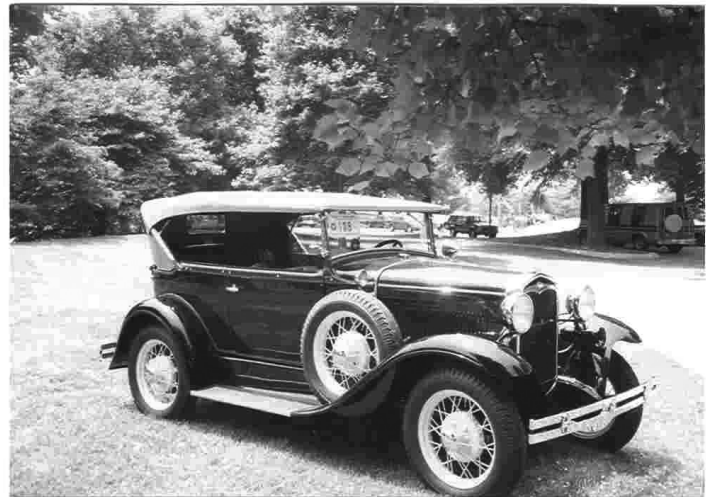

1931 Deluxe Two Door Phaeton

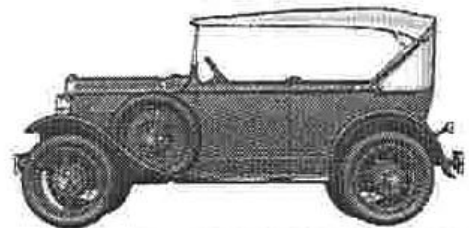

1930-31 DELUXE PHAETON (180-A)

OPEN CARS

TAIL LIGHT

Specifications:

Parking, Tail: 3 CP, single contact Mazda 63
 Stop: 21 CP, single contact Mazda 1129

The following new parts are required to complete a restoration of your Tail Lights. This is only a guide - do not assume that this is all that is needed, all other parts need to be thoroughly checked.

1. Tail Light Rim - A13448SS
2. Tail Light Gasket Set - A13461
3. Replacement Screw Set - A13405SK
4. Lens - choose your style - A13450
5. Snap Rings - A13456
6. Licence Plate Lens - A13445
7. Retainer clips - A13446S
8. Tail Light socket Set -A13412S
9. Reinforcing Plate - A13463
10. Bracket to Fender Mounting Bolts - A13474B, SS
11. Tail Light Bracket/Fender Rubber Pad - A13520
12. Tail Light / Stop Light Bulbs - A13465 & A13466
13. Licence Plate Bolt - A13407MB
14. Stoplight Switch - A13480A or B

Duo-Lamp Tail Light Repair Parts

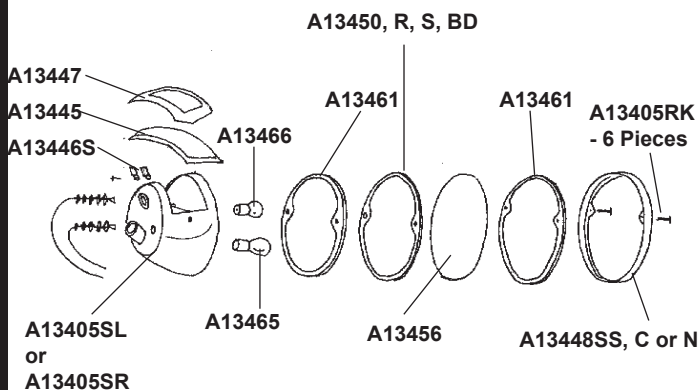

"Duolamp" Tail Light

Copy of the original. Stainless Steel. Commercials used black painted - left side has white lens - right side, no lens. Complete with half amber lens, bulbs and wiring - also includes bracket screws.



A13405SL 28-31 Left Price Ea. \$ 37.95

A13405SR 28-31 Right Price Ea. \$ 37.95

"Duolamp" Tail Light Replacement Screw Kit

This is all of the screws that you will need to refurbish your Tail light. 1 Set per Tail Light.



A13405SK 28-31 Price Set/8 \$ 3.65

Stop Light Bulb

21 Candle Power.



A13465 28-31 Price Ea. \$ 1.00

Tail Light, Parking Light, Cowl, Instrument Panel & Dome Light Bulb

3 Candle Power as original.

10 Candle Power is available if you would prefer a brighter bulb.



A13466/3 3 CP Price Ea. \$ 0.90

A13466/10 10 CP Price Ea. \$ 1.25

Quartz Bulbs

If you want a lot more light, use these direct replacements for your original bulbs. These are also known as "Ugly Bulbs".



Tail Light and Parking: 20 Watt

B13466Q6 6 Volt Price Ea. \$ 13.75

B13466Q12 12 Volt Price Ea. \$ 11.00

Stop Light: 50 Watt

B13465Q6 6 Volt Price Ea. \$ 13.75

B13465Q12 12 Volt Price Ea. \$ 11.00

Cowl & Tail Light Visor

Match up your Cowl & Tail Lights with a visor set. Just like the headlight set - see Page Gen. 185.



A13001A 28-31 W/Jewel Price Pair \$ 23.00

Mike's "A" FORD-ABLE Parts

Tail Light Rim

We only keep the stainless as these will not rust.



A13448SS 29-31 Stainless

Price Ea. \$ 5.75

LED Replacement Tail Light - All Red or Half Amber

Use this brand new product in your duo lamp housing and have the advantage of LED Tail lights. 6 or 12 Volt.

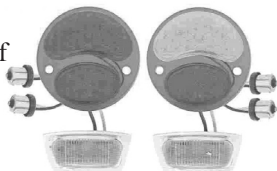

12 Volt

A13453	Right - Half Amber	Price Ea.	\$ 40.00
A13453R	Right - Red	Price Ea.	\$ 40.00
A13454	Left - Half Amber	Price Ea.	\$ 40.00
A13454R	Left - Red	Price Ea.	\$ 40.00

6 Volt

A13455	Right - Half Amber	Price Ea.	\$ 43.00
A13455R	Right - Red	Price Ea.	\$ 43.00
A13457	Left - Half Amber	Price Ea.	\$ 43.00
A13457R	Left - Red	Price Ea.	\$ 43.00

Tail Light All Red Lens

If your state does not allow amber stop lights, this all red lens is available.



A13450R 1928 - Sept. '29

Price Ea. \$ 5.25

Tail Light Half Amber Lens

This lens has a red section for the tail light and amber for the stop light.



A13450 Sept. '29 - till end '31 Price Ea. \$ 6.00

Tail Light Stop Lens

This is a glass red lens with the letters "STOP" molded in amber.



A13450S 29-31

Price Ea. \$ 8.95

Tail Light Blue Dot Lens

This is the all-red lens with the blue dot already installed in the stop section.



A13450BD 29-31

Price Ea. \$ 13.75

Tail Light Blue Dot

For the DIYer, you can fit your own blue dot in with this. It has a chrome rim. 1 Piece Set. Need 1 Set for one lens.



A13450D 28-31

Price Set \$ 4.95

Tail Light Snap Ring

This was used to hold the lens in the tail light rim. The sequence was the rim gasket, then the lens, then the snap ring.

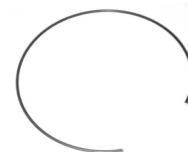

A13456 29-31

Price Ea. \$ 0.95

Tail Light Gasket

This goes between the face of the lens and the rim but many put one on both sides of the lens to reduce the risk of cracking.



A13461 29-31

Price Ea. \$ 0.50

License Plate Lens

This is the clear lens for the left side tail light to illuminate the license plate.



A13445 29-32

Price Ea. \$ 3.45

License Lens Gasket

This is the gasket for the clear license lens.



A13447 29-32

Price Ea. \$ 0.50

License Lens Retainer Clips

Two retainers and screws to hold the license lens in the tail light.

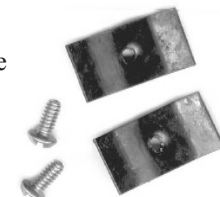

A13446S 28-32 4 piece set

Price Set/4 \$ 1.50

Tail Light Loom

This is what Ford used to protect the tail light wires from the elements. Extends from tail light through fender to under body.

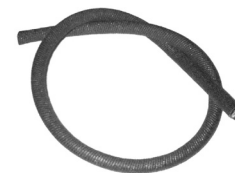

A13412L 28-31

Price Ea. \$ 1.25

Give us your email address, confirmation and tracking info will be right at your fingertips! **Open65**

OPEN CARS

Mike's "A" FORD-ABLE Parts

Tail Light Wire Clip

This clip holds the tail light loom to the fender.

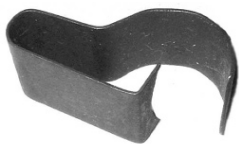

A14565 28-31 Price Ea. \$ 2.65

Tail Light Socket

Press this socket into the tail light bucket to hold the bulb.



A13412S 29-31 Price Ea. \$ 0.65

Double Contact Socket

These universal style sockets are used to convert any lamp to a dual filament bulb that can be used for turn signals. Use staggered pin bulbs. Some modification to your lamp will be needed to accept these.



A13412DC 28-31 Price Ea. \$ 8.10

Tail Light Wire Pigtails

This pigtail with springs and washers extends out the back of the tail light to make your connection. Correct fabric and colors. Black for Taillight / Green for Stop Light.



A13412/13 29-48 Price Pair \$ 3.60

Tail Light Cross Over Wire

This cross-over wire allows you to add a right tail light and then connect the two tail lights to the main harness.



A14423XO 28-31 Price Set \$ 9.00

Tail Light Reinforcing Plate

Lessen the risk of damaging your fender by using this plate under the fender to attach your tail light bracket.



A13463 29-31 Price Ea. \$ 3.25

Tail Light Bracket Pad

Protect your fender from metal to metal vibration with this rubber pad which fits between the fender and the tail light bracket.



A13520 29-31 Price Ea. \$ 1.60

Tail Light Bracket

These brackets are ready to mount. Same gauge steel Ford used. Used with teacup style tail lights.



A13471R	29-31	Right	Price Ea.	\$ 9.85
A13471L	29-31	Left	Price Ea.	\$ 9.85
A13471RC	29-31	Right - Chrome	Price Ea.	\$ 13.95
A13471LC	29-31	Left - Chrome	Price Ea.	\$ 13.95

Tail Light Bracket Bolts

This set of 3 special carriage bolts and nuts is used to bolt the tail light bracket to the fender. Bolts have large heads. 3 X 1/4-20 5/8 Bolt with Large Head.



Not used on Early Phaetons - See A13469X below.

A13474BK	29-31		Price Set/6	\$ 1.75
A13474SS	29-31	Stainless steel	Price Set/9	\$ 3.25



1928 Phaetons				
A13469X	1928		Price Set	\$ 0.95

Rear License Bracket

An identical reproduction of the original.

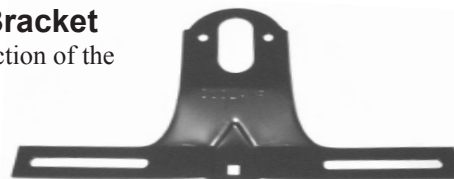

A13406D	28-31		Price Ea.	\$ 6.50
A13406SS	29-31	Polished Stainless Steel	Price Ea.	\$ 15.95

Rear License Plate Special Bolts

The nuts and bolts necessary to mount your license plate.



A13407MB	28-31		Price Set/4	\$ 4.35
----------	-------	--	-------------	---------

Mike's "A" FORD-ABLE Parts

License Plate Reflector Bolts

A reproduction of an aftermarket accessory. These bolts are sold in pairs and available in four different colors.



A13408	Blue		
A13409	Amber		
A13410	Green		
A13411	Red		
		Price Pair	\$ 1.00

Stop Light Switch

The early A's used this type switch which mounted on the transmission. Don't forget to order your link **A13507R**. Best Quality.



A13480A	28-30	Price Ea.	\$ 5.95
---------	-------	-----------	---------

Stop Light Switch Link

This is the metal link for the **A13480A** stop light switch.



A13507R	28-29	Price Ea.	\$ 1.45
---------	-------	-----------	---------

Stop Light Switch

A few '29's had this but mostly for '30-'31's. This bolts to the cross member of the frame. Needs **A2465B (Page Gen. 50)** Pedal to Brake shaft rod. Best Quality.

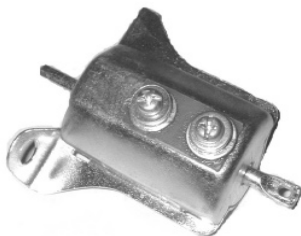

A13480B	30-31	Price Ea.	\$ 5.00
---------	-------	-----------	---------

Stop Light Switch Mounting Bolts

Here are the bolts, nuts, and lock washers to mount the '30-'31 style stop light switch to the cross member. **2 - 1/4-20 x 1/2" Bolts, lockwashers and nuts.**



A13480MB	30-31	Price Set/6	\$ 0.55
----------	-------	-------------	---------

See Page Open 70 for the complete Turn Signal Section.

1928 / 1929 Stoplight Switch Mounting

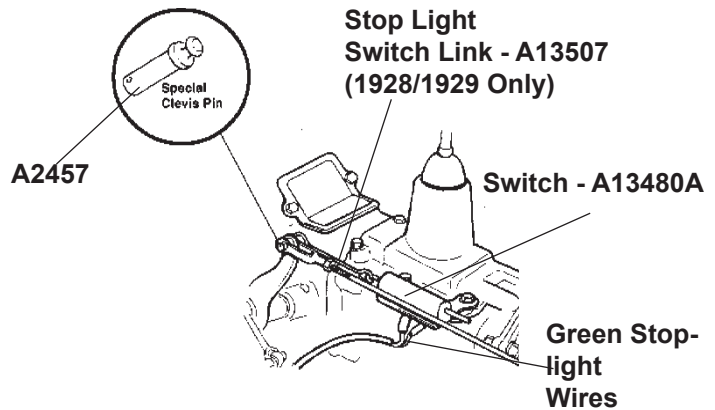

1930 / 1931 Stoplight Switch Mounting

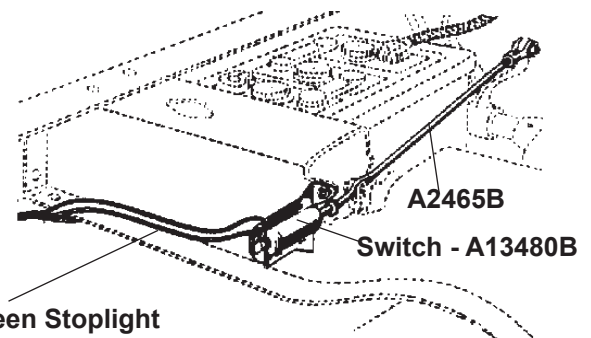

Thanks to Les Andrews for the use of his drawings.

Custom LED Third Brake Lights

Custom LED Third Brake Light fits in the back window of cars and trucks. Strong, twin suction cups attach the rugged, black ABS case to the glass in the back window. Two wire, easy hookup works with 6V or 12V negative or positive ground vehicles. Electronics feature all solid state components (nothing to wear out and the LEDs should last for over 25 years!). No permanent modifications to your car are required. Kit comes with Third Brake Light, harness, connectors, mounts, and suction cups. Logo Lites Custom LED Third Brake Lights are backed by a one year manufacturer's warranty.



A13312S	STOP	Price Kit	\$ 72.00
A13312A	1928	Price Kit	\$ 72.00
A13312B	1929	Price Kit	\$ 72.00
A13312C	1930	Price Kit	\$ 72.00
A13312D	1931	Price Kit	\$ 72.00

A custom Third Brake Light is available. Any 4 Characters of your choice is available, eg MIKE.

A13312O	Special 4	Price Kit	\$ 99.65
---------	-----------	-----------	----------

DRUM TAIL LIGHT

Stop Light Bulb

21 Candle Power.

See Quartz Bulbs on Page Open 64.



A13465 28-31 Price Ea. \$ 1.00

Tail Light, Parking Light, Cowl, Instrument Panel & Dash Light Bulb

3 Candle Power as original.

10 Candle Power is available if you would prefer a brighter bulb.



A13466/3 3 CP Price Ea. \$ 0.90

A13466/10 10 CP Price Ea. \$ 1.25

Complete Drum Tail Light

Top quality reproduction with the black bracket and nickel body. Used on '28's and early '29's. All black - used on commercial Vehicles.

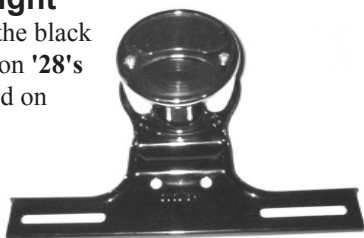

A13405DPL - Passenger - Left - Nickel Ea. \$ 110.00

A13405DPR - Passenger - Right - Nickel Ea. \$ 110.00

1) Assemble contact-insulating washers and rivets. Seat down & upset rivet so that contact can be rotated.

2) Assemble divider plate using 3/16" rivets.

3) To install backing plug; tap into hole from front with slot turned clockwise until slot is level with plate. Rotate contact and plug so contact enters small slot in brass plunger. When aligned tap in until locking plunger enters hole in rear of plate.

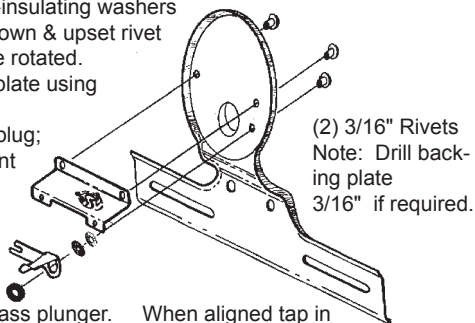

(2) 3/16" Rivets
Note: Drill backing plate 3/16" if required.

Drum Tail Light License Bracket

Top quality steel reproduction. Paint Black.



A13406AR 28-29 Price Ea. \$ 28.50

Drum Tail Light and License Bracket to Support Bracket Bolts



Two 5/16-24 x 11/16 Hex Bolts, L/w's and Nuts.

A13607 28 - Early '29 Price Set \$ 0.50

Drum Tail Light Support Bracket to Body Bolts



Two 5/16-24 x 5/8 Hex Bolts and L/w's.

A13673 28 - Early '29 Price Set \$ 0.50

Drum Tail Light Bracket

Used on drum tail lights.

These were used from 1928-July 1929 Roadsters.



A13470AL 28-29 Left Price Ea. \$ 17.95

A13470AR 28-29 Right Price Ea. \$ 23.50

Drum Tail Light Bracket

These brackets were mounted onto the rear sub-frame of the body for the drum tail lights to mount onto.

Originally were only used on the left, so you will have to drill the right sub-frame to mount the right.

Used on the Phaetons.



A13473AL 28-29 Left Price Ea. \$ 22.50

A13473AR 28-29 Right Price Ea. \$ 22.50

Drum Tail Lamp Socket

This is the bulb socket for the '28-'29 drum tail light.

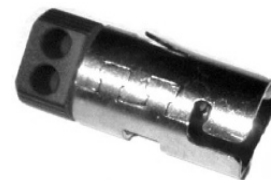

A13410A 28-29 Price Ea. \$ 34.98

Drum Tail Light Divider Plate

This divider plate separates the tail lamp from the stop lamp sections on the drum style tail light.

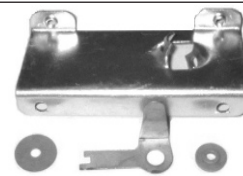

A13406DP 1928 - Early 1929 Price Set \$ 21.75

Mike's "A" FORD-ABLE Parts

Drum Tail Light Body

This is a very good nickel-plated reproduction. Body only.



A13440DBPL - Passenger - Left - Nickel
A13440DBPR - Passenger - Right - Nickel

1928 - Early '29 Price Ea. \$ 31.00

Drum Retainer Screws

This is the special hardware necessary to hold the tail light body and lens on.



A13441BT 28-29

Price Set/6 \$ 5.75

Drum Stop Face Plate

This steel insert with the word "STOP" fits behind the red lens.



A13442AR 1928 - Early '29

Price Ea. \$ 6.30

Drum White License Lens

For the '28 drum tail light only.

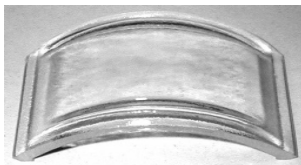

A13445AR 1928 - Early '29 Price Ea. \$ 10.00

Drum Retainer Clips

Two retainers and screws to hold the license lens in the drum tail light.

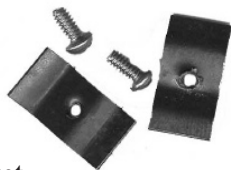

A13446S 28-31 4 piece set

Price Set/4 \$ 1.50

Drum License Lens Gasket

This is the gasket for the '28 license lens on the drum tail light.



A13447AR 1928 - Early '29 Price Ea. \$ 0.75

Drum Red Lens

This is an all-red lens for the '28 drum tail light.



A13450AR 28-29 Price Ea. \$ 7.60

Drum Tail Light Lens Gasket

This is the round gasket for the drum tail light.



A13461AR 1928 - Early '29 Price Ea. \$ 0.60

Drum Tail Light Wire Clip

You'll need two of these to hold the wire to the tail lamp bracket on the '28 drum tail light.



A14595 1928 - Early '29 Price Pair \$ 2.95

Drum Tail Light Extension Wire

This wire goes from the drum tail light to the main wiring harness.

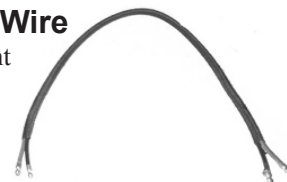

A14423AR 28-29 Price Ea. \$ 5.65

Order Online Now and Save 5%

Visit our website for all your Model "A" needs.



www.mikes-afordable.com

Give us your email address, confirmation and tracking info will be right at your fingertips! **Open69**

OPEN CARS

Turn Signals

Turn Signal Kit (6 Volt)

BE SAFE. Signal Stat. Add this complete turn signal kit directly to your tail lights. Kit includes the switch, fuse, flasher, flasher socket and complete instructions. Cowl conversion kit works with this one. If you do not have cowl lights you will need to install front turn signal lights of some sort. Comes with instructions. 11 Piece Set.



A13310A **28-31** **Price Set/11 \$ 58.95**

Turn Signal Flasher

6-Volt flashers are hard to find; you'll need this if you have added turn signals to your A.



A13311 **28-31** **Price Ea. \$ 5.25**

Turn Signal Lamps

If you are using the **A13310A** Turn Signal Kit these are the turn signal lights that will fit between the bumpers bars on the front and rear. No modifications needed. Don't forget to buy extra wire by the foot see wiring section - **Page Gen. 193**. Available for both 6 & 12 Volts. Use on front and rear.



A13405T6	6 Volt - Amber	Price Ea.	\$ 20.95
A13405T6R	6 Volt - Red	Price Ea.	\$ 20.95
A13405T12	12Volt - Amber	Price Ea.	\$ 19.95
A13405T12R	12 Volt - Red	Price Ea.	\$ 19.95

LED Replacement Tail Light - All Red or Half Amber

Use this brand new product in your duo lamp housing and have the advantage of LED Tail lights. 6 or 12 Volt.

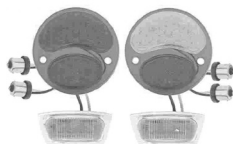

12 Volt			
A13453	Right - Half Amber		
A13453R	Right - Red	Price Ea.	\$ 40.00
A13454	Left - Half Amber		
A13454R	Left - Red	Price Ea.	\$ 40.00
6 Volt			
A13455	Right - Half Amber		
A13455R	Right - Red	Price Ea.	\$ 43.00
A13457	Left - Half Amber		
A13457R	Left - Red	Price Ea.	\$ 43.00

Complete Turn Signal Kit (6 or 12 Volt + or -)

Now you can have super bright Amber LED turn signals for your "A"! Kit includes super bright LED turn signals, stainless steel brackets, controller and wire. The easy hookup connects to 6 Volt OR 12 Volt cars with negative or positive ground without even flipping a switch. The kit features all solid state components (there are no turn signal flashers to wear out and the LED's will last for over 25 years!). The whole kit is bolted on so you don't have to permanently modify your car. Slim line turn signals mount to bumper clamp bolts and have a one wire hook up. Each turn signal is individually short circuit protected so if one wire shorts to the chassis, only that one light won't come on. Eliminate the short and the turn signal will work again. Also has a hazard light function and is backed by a one year manufacturer's warranty. 20 Piece Set.

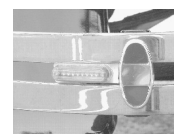
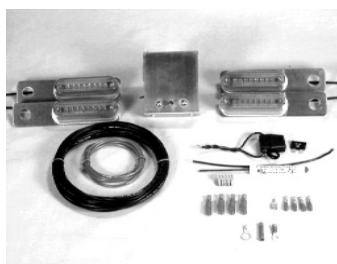

A13311A **28-31** **Price Kit/20 \$ 169.95**

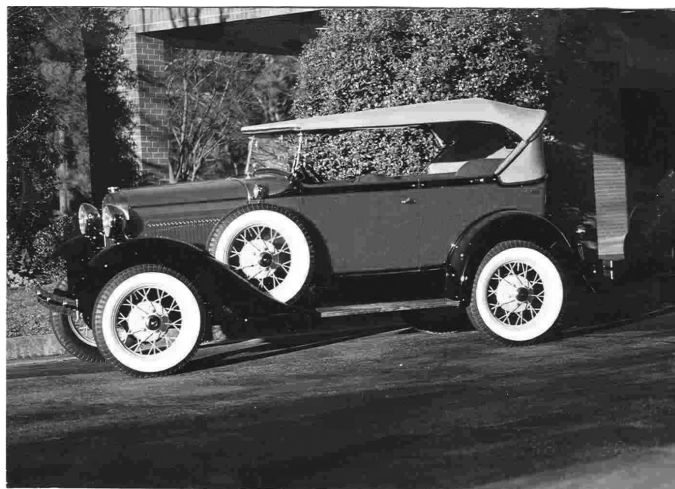

1931 Deluxe Two Door Phaeton

Dash Light

Specifications:

Instrument Panel:	3 CP, single contact, Mazda 63
Dome:	3 CP, single contact, Mazda 63
Commercial Dome:	15 CP, single contact, Mazda 87

Dash Light

This mounts in the middle of the dash on the '28-'30 A's with the oval speedometer. Attach the dash wire to the charge post on the amp meter.



A13708AR 1928 - June 1930 Price Ea. \$ 22.55

Dash, Cowl & Parking Light Bulb

3 Candle Power as original.
10 Candle Power is available if you would prefer a brighter bulb.
See **Page Open 64** for Quartz Bulbs.



A13466/3	3 CP	Price Ea.	\$ 0.90
A13466/10	10 CP	Price Ea.	\$ 1.25

Dash Light Cover

This is the cover only for the dash light on the '28-'30 oval speedometer. Only fits repro Dash light.



A13705 28-30 Price Ea. \$ 13.70

Dash Light Bracket

If your dash light mounts up under the dash, you'll need one of these brackets.



A13706BRO 30-31 Open car. Price Ea. \$ 1.55

Dash Lamp Cap Only

For Open and Closed Cars.
Switch Type.



A13705B 30-31 Price Ea. \$ 13.50

Dash Light (Excellent Replacement)

This is the dash lights for the '30-'31 A's with the round speedometer; this mounts under the dash rail.
See **A13710** for dash light armored cable.



A13708C June '30 - till end '31 Open Car Price Ea. \$ 24.15

Dash Light Armored Cable

This 1/8" diameter single strand cable is used for the dash light but can also be used for a sport light. Cut and sold in 12" lengths.

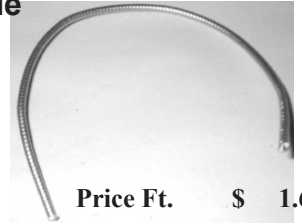

A13710 28-31 Price Ft. \$ 1.65

See **Page Gen. 198** for Wire - Sold by the Foot.

See **Page Gen. 189** for Ignition Switch, Instrument Panels & Parts.



1929 Standard Phaeton

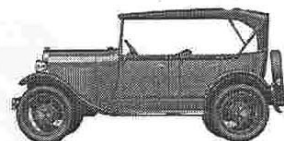

1928-29 STANDARD PHAETON (35-A)

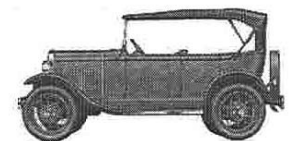

1930-31 STANDARD PHAETON (35-B)

Garnish Moldings & Frames

Open Car Rear Window Frame Kit

Mike has the rear window frame for the open car in stainless steel. Complete with glass. 7" x 16 1/2" outside.



'28-'31 Roadsters & Phaetons.

The specified finishes for the inside steel frame are:

Deluxe Roadster & PhaetonSatin Golden Beryl
Standard Roadster & PhaetonSatin Black

A37639SS	28-31	Stainless - Outside only.	
		Price Set	\$ 132.00
A37644	28-31	Glass Only	
		Price Ea.	\$ 23.50



Mr. & Mrs. R.T. McDaniels Roadster & Phaeton - notice all of the accessories on both cars.

Sill Plates

1928-29 Open Car Sill Plates

This is an excellent reproduction of the sill plate used on the '28-'29 Roadsters and Phaeton.



A1033A 28-29 Roadster and Phaeton Front Door
Price Pair \$ 130.00

Phaeton Rear Sills

These sill plates have the correct Ford script placement but you have to cut a bit to fit them properly.

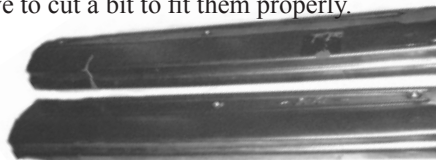

A1033PR 28-29
Price Pair \$ 130.00

Sill Plate Extensions

The '28-'29 Phaetons used these extensions between the rear seat riser and the side of the body. The upholstery panel sets on these.



A1033EXT 28-29
Price Pair \$ 37.95

Sill Plate Brackets

This bracket goes between the subrail and the sill plate on:

1928 - 29 Roadster
1928 - 29 Phaeton - need 2 Pair.



A1034 28-29
Price Pair \$ 36.00

Sill Plate Screws - Open Car

The correct screws for the Open Car Sill Plates. **Eight #10 x 3/4** Oval head sheet metal screws.



A48653 28-31 **Price Set/8 \$ 1.00**

Seat Parts

Seat Adjuster Handle

This brass chrome-plated style handle was used on:
1931 Deluxe Phaeton

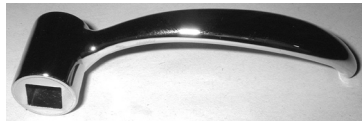

A47836B 30-31 Price Ea. \$ 12.95

Seat Adjuster

A saw-tooth style seat adjuster. Mounting bracket is at the front of the seat. Mounting bracket to the floor is not included. Used on:
1931 Deluxe Phaeton



A70124 1931 Price Ea. \$ 63.00

Seat Adjuster Spring

This 6" spring is used with the saw-tooth style adjuster - A70124.



A70124L 1931 Price Ea. \$ 4.40

Seat Clips

The '28-'29 Roadsters used these special clips that attach to the seat back wood to hold the seat spring in place.

5 Piece Set - Need 1 set per Car.

RAR253 28-29 Price Set/5 \$ 23.00



Seat Stiffener

This set which is located on the back of the seat frame includes 3 braces and one long stiffener.

Used on '28-'29 Roadster.



A121ABRACE 28-29 Price Ea. \$ 51.00

Seat Vent Grommet

Put this steel grommet under the bucket seats on the hard board panel.

For Deluxe Phaeton.

A47906 30-31 Price Ea. \$ 2.25



Support Stud

These studs will support the back edge of the bucket style seats that were used on the Deluxe Phaeton.



A70127 30-31 Price Ea. \$ 7.00

Seat Hinge Channel

This channel bolts to the seat wood and has a hole in it for the seat hinge rod (A70145) to pass through. For very early Deluxe Phaetons.
16" Long.



A70144 30-31 Price Ea. \$ 38.00

Seat Hinge Rod / Nut

This rod/nut is removed to change the seat adjustment on the very early Deluxe Phaetons. The 5/16" threaded rod goes through the floor bracket and hinge channel.
17 5/4" Long.



A70145 30-31 Price Ea. \$ 24.95

Seat Hinge Channel Reinforcement

Used on the very early Deluxe Phaetons. Use this channel reinforcement on top of the wood above the A70144 hinge channel to secure it to the seat wood.

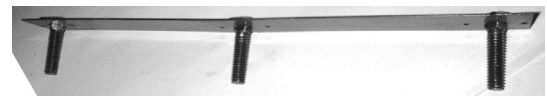

A70146 30-31 Price Ea. \$ 19.95

Rear Seat Male Catch

This catch is attached to the back seat backrest then secured to the back of the car. Used on all Deluxe Phaetons.



A70147 30-31 Price Ea. \$ 18.75

Seat Cushion Dowel

Holds seat cushion onto the body subrail so that cushion (springs) will not move. Need 2 per seat.

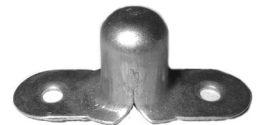

A121D 28-31 Price Ea. \$ 10.25

Seat Track Assembly

This is the slide track with 3 seat studs for the Tudor Phaeton.



A84842BR 30-31 Price Set/4 \$ 57.60

Mike's "A" FORD-ABLE Parts

Rear Floor Pan Spring Hump Cover

Originally Ford used roof material to cover the hump on the rear floor pan. Used on:

1931 Deluxe Phaeton



A85456C 1931 Price Ea. \$ 4.50

Rear Floor Pan Spring Hump Straps

This 4 piece set of metal straps hold the cover A85456C in place over the spring hump.



RAR220 1931 Price Set/4 \$ 23.45



1931 Roadster built at Mike's in 2001. This car has won a number of 1st Place Awards.

OPEN CARS

Seat Springs

28-29 Roadster

S100	Front Cushion	\$ 79.50
S101	Front Backrest	\$ 70.75
S102	Rumble Cushion	\$ 64.25
S103	Rumble Backrest	\$ 83.75

30-31 Roadster

S104	Front Cushion	\$ 77.25
S105	Front Backrest	\$ 66.75
S106	Rumble Cushion	\$ 64.25
S107	Rumble Backrest	\$ 83.75

28-29 Phaeton

S701	Front Cushion	\$ 79.50
S702	Front Backrest	\$ 69.75
S703	Rear Cushion	\$ 81.25
S704	Rear Backrest	\$ 69.75

30-31 Phaeton (Standard 4 Door)

S705	Front Cushion	\$ 77.25
S706	Front Backrest	\$ 67.25
S707	Rear Cushion	\$ 72.25
S708	Rear Backrest	\$ 69.25

30-31 Deluxe Phaeton (Tudor Door)

S709	Front Cushion - Driver or Passenger	\$ 47.00
S710D	Front Backrest - Driver	\$ 35.75
S710P	Front Backrest - Passenger	\$ 35.75
S711	Rear Cushion	\$ 109.25
S713	Rear Backrest	\$ 67.25

Upholstery

DUE TO THE ENORMOUS SELECTION OF UPHOLSTERY CHOICES FOR THE MODEL A'S - WE HAVE LEFT THE UPHOLSTERY SECTION TOGETHER.

SEE PAGE Gen. 224 FOR ROADSTER AND PHAETON INTERIOR KITS.

SEE PAGE Gen. 225 FOR ROADSTER AND PHAETON COWL AND DOOR PANEL SETS

SEE PAGE Gen. 226 FOR ROADSTER AND PHAETON TOPS AND PADS

SEE PAGE Gen. 227 FOR ROADSTER AND PHAETON SIDE CURTAINS

1931 Deluxe Roadster owned by Mr. T. Philips



Mike's "A" FORD-ABLE Parts

Notes

Notes

OPEN CARS

