

COMMERCIAL VEHICLES

- 1928 & 1929 ROADSTER PICKUP 76A**
- 1930 & 1931 ROADSTER PICKUP 76B**
- 1928 & 1929 CLOSED CAB PICKUP 82A**
- 1930 & 1931 CLOSED CAB PICKUP 82B**
- 1928 & 1929 PANEL DELIVERY 103 1/2" WHEELBASE 79A**
- 1930 & 1931 PANEL DELIVERY 103 1/2" WHEELBASE 79B**
- 1928 & 1929 PANEL DELIVERY 131 1/2" WHEELBASE 85A**
- 1930 & 1931 PANEL DELIVERY 131 1/2" WHEELBASE 85B**
- 1928 & 1929 DELUXE DELIVERY 130A**
- 1930 & 1931 DELUXE DELIVERY 130B**
- 1928 & 1929 TAXICAB 135A**
- 1929 STATION WAGON 150A**
- 1930 & 1931 STATION WAGON 150B**

Index	Page #
Books & Accessories	P/UP 4
Bed Parts - Closed Cab & Roadster PU ...	P/UP 22
Bodies - Roadster Pickup	P/UP 3
Dash & Dome Light	P/UP 73
Door Handles & Parts - Closed Cab PU ...	P/UP 42
- Roadster PU	P/UP 39
Drum Tail Light	P/UP 70
Fenders & Brackets - Rear	P/UP 15
Garnish Moldings & Frames	P/UP 74
Gas Gauge	P/UP 57
Gas Tank	P/UP 52
Glass Sets & Pieces	P/UP 31
Hood	P/UP 16
Insulation	P/UP 51
Mirror	P/UP 63
Muffler	P/UP 21
Radiator Shell	P/UP 21
Running Boards & Parts	P/UP 21
Seat Parts	P/UP 76
Sheet Metal	P/UP 5
Sill Plates	P/UP 76
Speedometer	P/UP 59

Index	Page #
Spring - Rear	P/UP 21
- Seats	P/UP 77
Sun Visors	P/UP 11
Tail Light	P/UP 65
Tires & Spare Tires	P/UP 14
Top Parts - Closed Cab Pickup	P/UP 37
- Roadster Pickup	P/UP 36
Turn Signals	P/UP 72
Upholstery	P/UP 77
Windshield Wipers	P/UP 32
Windshields & Parts - Closed Cab PU ...	P/UP 28
- Roadster PU	P/UP 26
Wood	P/UP 12

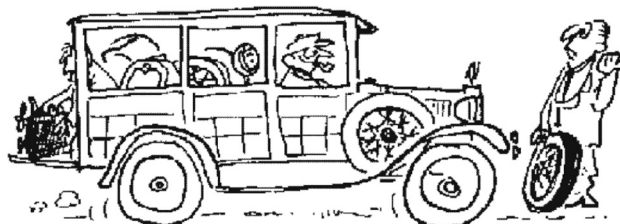

Going to Mike's?

Mike's "A" FORD-ABLE Parts

1928 - 1931 Narrow Bed 41 1/2" Wide Stamped Steel Parts

A Typical Square
Type 1928 - 1929
CAB

A307ESL,
307ESR,
A308CSL,
A308BSR

A873 or A873SS

AM870ACC

A872

A969AB

AM877ACU

AM877ACB

AWD1225

A878

A871S

A960AB

A964AB

Inner
Patch
Panels -
A436B1,
A836A1

A950ABNS

Outer Patch
Panel A836A,
A836B(30-31)

A976AB

A950ABNS

A953AB

A874 &
A959A

A973AB

AM711(30-31)

A958AB

A955AB

A961AB

A952AB

A970AB

A966AB

A963AB

A951ABNS

A965AB

A967AB

PICKUP

1928 - 1931 MODEL "A" ROADSTER PICKUP

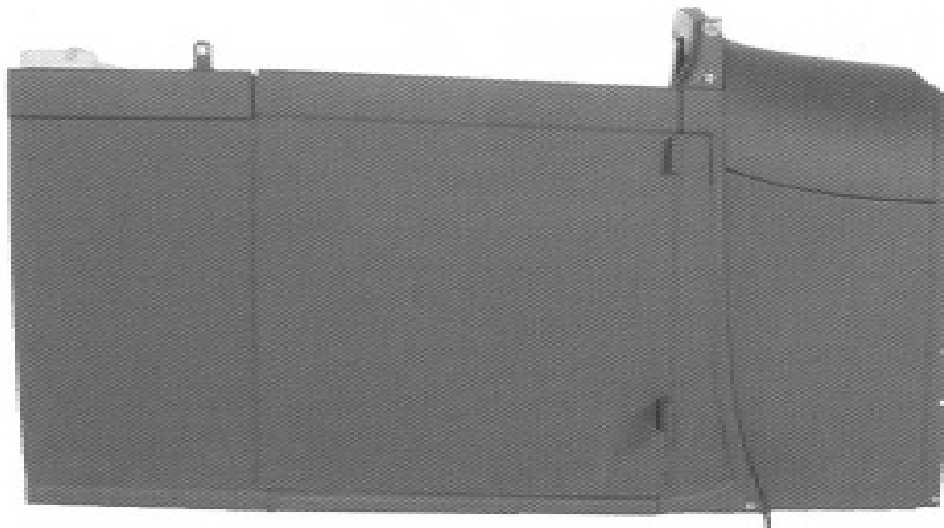

**NO INDENTED
FIREWALLS
AVAILABLE!!**

All Steel '28 x '29 or '30 x '31 Roadster Pickup Body which comes complete with the following parts installed: **Dash Rail, complete Interior Wood Kit, Wood or Steel Floor Boards, Seat Frame, Doors Complete with Hinges & Latches Mounted on Body, Body to Frame Mounting Blocks.** Must use Original Gas Tank - **NOT INCLUDED.** There is a \$250.00 crating fee.

AT-100-A

28-29 Stock Roadster Pickup Body
Price Kit \$ 4,300.00

AT-100-B

30-31 Stock Roadster Pickup Body
Price Kit \$ 4,300.00



1931 Roadster Pickup with Deluxe Fold Down Top (Not Original) Built by Mike's "A" Ford-able Parts.

Books & Accessories

Restoring the Model "A" Pickup

50 Pages. 80 Pictures. This book shows many beautiful photos of restored Pickup's in different locations.

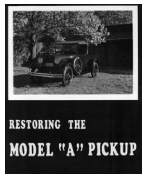

A91009A 28-31 Price Ea. \$ 30.50

AA Truck - Supplement to Restorer's Model A Shop Manual

92 Pages. A great restoration guide for your AA Truck. Written by Jim Schild. At this time we do not sell AA Running Chassis Parts.

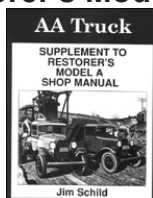

A91009B 28-31 Price Ea. \$ 24.00

Model A & AA Ford Truck Owner

288 Pages. A Hard bound book covers field uses, body types, accessories, capacities, original prices and specs. Adapted from Truck Fax: The Ford Truck in Trade and commerce, and exhaustive 1930 documentation for dealers, product presentation & non-factory equipment offerings. 500 Illustrations.

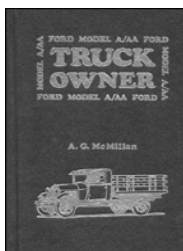

A91002 28-31 Price Ea. \$ 26.00

Model A and AA Engine Chassis Manual

40 Pages. Covers Model A and AA trucks / a reprint of a Dykes supplement which includes specifications and operating instructions, contains wiring diagrams and lubrication charts / 64 illustrations.



A91044 28-31 Price Ea. \$ 14.00

The New Ford Truck

12 page sales booklet in 2 colors. Features all truck and commercial cars, plus specifications, illustrated.

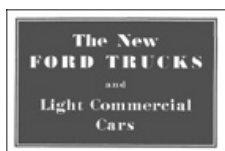

A91054 28-31 Price Ea. \$ 5.00

Roadster Pickup Key Fob

A wonderful gift idea. A silver plated brass key fob with a swivel feature that keeps the image always in view.



A18905 Roadster Pickup Price Ea. \$ 19.95

Pickup Car Covers

For indoor storage only. Poly cotton material.



C2502PD Price Ea. \$ 149.95

Commercial Wallpaper Border

A wonderful finishing touch for your office or shop. Pre-pasted vinyl wall paper strips. 15' X 6.875".

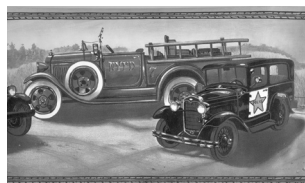

A18820 Price Roll \$ 10.50



1929 Panel Delivery 130A

Mike's "A" FORD-ABLE Parts

Sheet Metal

Roadster and Closed Cab Pickup Sub-Rails

The floor pans and body panels all attach to these subrails at the bottom of the body. The correct length, ready to install, except the A432BF Subrails are actually for the Tudor Sedan, but the front section will work on '30-'31 Closed Cab Pickups once they have been cut.



A1032A	28-29	Roadster Pickup		
			Price Pair	\$ 280.00
A1032B	30-31	Roadster Pickup		
			Price Pair	\$ 280.00
A832AF	28-29	Closed Cab Pickup		
			Price Pair	\$ 280.00
A432BF	30-31	Closed Cab Pickup		
			Price Pair	\$ 280.00

Roadster and Closed Cab Subrail Extension - Floor Board Braces

Used on the Front of the Subrails for the Floorboards to mount onto. 4 Pieces.



A132EXB	30-31		Price Set/4	\$ 220.00
---------	-------	--	-------------	-----------



A132EXA	28-29		Price Set/4	\$ 170.00
---------	-------	--	-------------	-----------

Roadster Pickup Cross Channels

These cross-rails connect the subrails to give a good foundation for the floor pan and floorboards on the '28-'31 Roadster Pickup.



A1031A	28-29	2 Pieces	Price Set	\$ 79.00
--------	-------	----------	-----------	----------



A1031B	30-31	2 Pieces	Price Set	\$ 114.00
--------	-------	----------	-----------	-----------



A1031RB	30-31	Rear Panel	Price Ea.	\$ 85.00
---------	-------	------------	-----------	----------

Closed Cab Body Channels

Your Floorpans attach to these. 48 1/2" Long. Measurements are approximate. These do not come with "D" nuts, and will have to be trimmed to fit.



A131	28-31	1 x 3" x 3/4" Lips 2 x 2" x 3/4" Lips	Price Set	\$ 65.00
------	-------	--	-----------	----------

Rear Closed Cab Support (Rear Crossmember)

This is sometimes called the rear cab cross member because it fits between the seat riser and the back of the cab on the floor. 45 1/4" x 6 3/4".



A831B	30-31		Price Ea.	\$ 80.00
-------	-------	--	-----------	----------

Complete Sub Frame Assembly - Roadster Pickup - Shipped by Freight Line.

Includes: Subrail, Cross Channel and pan under front seat frame, all primed and riveted together.

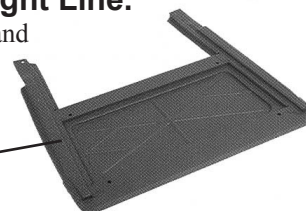

30-31 Shown.

A1032AASSEM	28-29	Roadster Pickup	Price Ea.	\$ 495.00
A1032BASSEM	30-31	Roadster Pickup	Price Ea.	\$ 513.00

Mike's "A" FORD-ABLE Parts

Floor Pan Under Front Seat

This panel serves as the floor pan and sits under the seat riser.



A835A 28-29 Closed Cab Pickup
Price Ea. \$ 49.00

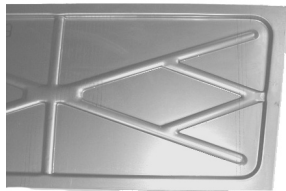

A135A 28-31 Roadster Pickup and
30-31 Closed Cab Pickup
Price Ea. \$ 49.00

Seat Riser

Mike also has these steel risers available which fit between the seat springs and the floor.



A821A 28-29 Closed Cab
Price Ea. \$ 64.00

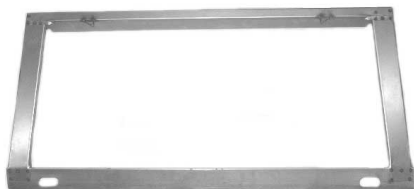

A821A1 28-29 Roadster Pickup
Price Ea. \$ 65.00

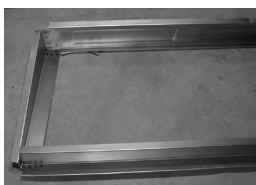

A821B 30-31 Closed Cab
Price Ea. \$ 64.00



A821B1 30-31 Roadster Pickup
Price Ea. \$ 64.00



A821BLT Mid 1931 Closed Cab
Price Ea. \$ 64.00

Seat Stiffener

This set which is located on the rear of the front seat Riser. Used on '28-'29 Roadster Pickup.



A121ABRACE 28-29 Price Ea. \$ 51.00

Cowl Quarter Patch Panels Roadster Pickup



A114A 28-29 Complete panel
Price Pair \$ 114.00



AM724 28-29 Bottom 6" Panel
Price Pair \$ 43.00

Complete panel.
22 3/4" x 25 1/4" x 16 1/4".



A114BF 30-31 Roadster Pickup
Price Pair \$ 285.00



13 1/2" x 6" High
A114B 30-31 All body styles
Price Pair \$ 26.95

Contoured Cowl Patch

A new correctly contoured patch has the compound curves of the cowl and also the correct beading. Available only for '30-'31.



A014BD 30-31 Price Pr. \$ 53.50

PICKUP

Mike's "A" FORD-ABLE Parts

Door Bottom Outer Patch Panel

Many old trucks have door bottoms that have rusted out. These patches are used to replace the damaged areas. Sold in pairs only. **All Closed Cabs** have raised beading, '28 - '29 **Roadster Pickup** have no beading.



A836A 28-29 Closed cab truck - 29" x 8 1/2"
Price Pair \$ 65.00



A136A 28-29 Roadster Pickup- 22 1/4" x 6"
Price Pair \$ 50.00



A836B 30-31 Closed Cab Pickup
Price Pair \$ 60.00



A136B 30-31 Roadster Pickup- 23 1/2" x 7 1/2"
Price Pair \$ 60.00

Door Bottom Inner Patch Panels



A436B1 30-31 Closed Cab Pickup -
25" x 4 3/4"
Price Set \$ 45.00

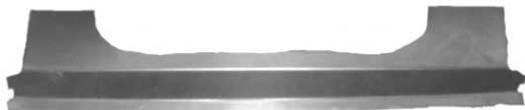

A836A1 28-29 Closed Cab Pickup - 29" x 6 1/2"
Price Set \$ 45.00

Roadster Pickup Doors

These are very good reproduction steel doors for the **Roadster Pickup** - front doors with hinges included. Be aware that the '28 did not have an outside door handle. Order accordingly.



A1046AR	1928	Left	Price Ea.	\$ 515.00
A1047AR	1928	Right	Price Ea.	\$ 515.00
A1046A	1929	Left	Price Ea.	\$ 515.00
A1047A	1929	Right	Price Ea.	\$ 515.00
A1046B	30-31	Left	Price Ea.	\$ 515.00
A1047B	30-31	Right	Price Ea.	\$ 515.00

Roadster Pickup Door Skins

If your inner door frame is in good shape, you may want to replace only the outer skin. Available for open cab only. Be aware that the '28 did not have an outside door handle and order accordingly. **The '28's are a special order.**

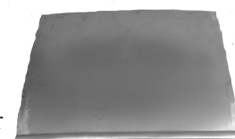

A1040AR	1928	Left	Price Ea.	\$ 199.95
A1041AR	1928	Right	Price Ea.	\$ 199.95
A1040A	1929	Left	Price Ea.	\$ 185.00
A1041A	1929	Right	Price Ea.	\$ 185.00
A1040B	30-31	Left	Price Ea.	\$ 185.00
A1041B	30-31	Right	Price Ea.	\$ 185.00

Closed Cab Pickup Door Skins

Die Stamped panels cover from the bottom of the door - up to the bead.



A307ESL	28-29	Left	Price Ea.	\$ 75.00
A307ESR	28-29	Right	Price Ea.	\$ 75.00
A308CSL	30-31	Left	Price Ea.	\$ 65.00
A307BSR	30-31	Right	Price Ea.	\$ 65.00

Closed Cap Pickup Curved Roof Panels

This panel goes above the door to the rib rail. You will have to drill holes to mount the panel and rain gutters.



A47776PL	30-31	Left	Price Ea.	\$ 130.00
A47776PR	30-31	Right	Price Ea.	\$ 130.00

Mike's "A" FORD-ABLE Parts

28-29 Closed Cab Lower Panel

This is a high quality reproduction of the complete lower panel for the back of the '28-'29 Closed Cab Pickup.

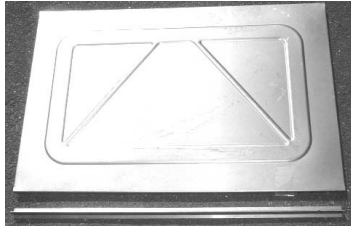

AM877ACB 28-29 Price Ea. \$ 210.00

28-29 Closed Cab Back Panel Clamp Strip

This strip is used to connect the upper and lower panels.

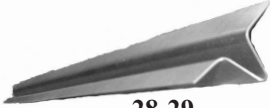

A65087 28-29 Price Ea. \$ 10.95

28-29 Closed Cab Upper Panel

This is a high quality reproduction of the complete upper panel for the back of the '28-'29 Closed Cab Pickup. The A65087 Clamp Strip (above) is included.



AM877ACU 28-29 Price Ea. \$ 225.00

Closed Cab Pickup Brace & Corner Bracket Assembly

This brace and corner assembly mounts in the upper back corner of the '28-Mid '30 Closed Cab Pickup. One left and one right corner bracket to tie the back panel brace to the door post.



A876 28- Mid 30 Price Set \$ 50.00

Complete Closed Cab Corners

This pair of complete cab corners really helps on a refurbishing project. These are exact in all details for the Closed Cab Pickup.

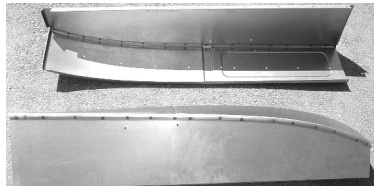

AM870ACC 28-Mid 30 Price Pair \$ 255.00

Closed Cab Pickup Rear Corner Patches

These die-stamped steel corners will fit onto the bottom rear of the cab on the '30-'31 Closed Cab Pickups. 6" High



AM711 Mid 30-31 Price Pair \$ 39.95

Closed Cab Pickup "T" Strip

Runs vertically between the cab corners and the back of the cab on '28-'29 Closed Cab Pickups.



A875T 28-29 Price Ea. \$ 44.85

Closed Cab Lower Cab Patch

This is a 48" long beaded panel to replace the bottom of your Closed Cab Pickup. 48 1/2" x 6 3/4"



A850B 30-31 Price Ea. \$ 32.50

Roadster Pick-Up Cab Backs

These cab backs are all steel for durability. Must ship via Freight line as they are too large for UPS. '28-'29 Includes Braces. '30-'31 does not include braces - see A877BBR.



A877A 28-29 Price Ea. \$ 175.00

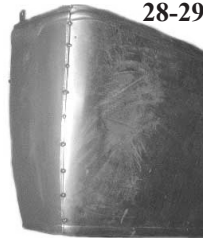

A877B 30-31 Price Ea. \$ 820.00

Roadster Pickup Cab Back Braces

These brackets are critical to keeping it all together. They go in the very back corner and connect the subrail, the rear quarter panel and the back panel together.



A877ABR 28-29 Price Pair \$ 66.00

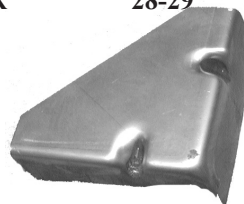

A877BBR 30-31 Price Pair \$ 154.00

PICKUP

Mike's "A" FORD-ABLE Parts

Roadster Pickup Rear Quarter Panels

These quarter panels are complete with or without braces.



With Braces

A1050A	28-29	Left	Price Ea.	\$ 210.00
A1051A	28-29	Right	Price Ea.	\$ 210.00

Without Braces

A1050AWO	28-29	Left	Price Ea.	\$ 151.00
A1051AWO	28-29	Right	Price Ea.	\$ 151.00

Roadster Pickup Braces For Quarter Panel

4 parts.



Left

A1050ABR	28-29	Roadster Pickup	Price Set	\$ 79.00
----------	-------	-----------------	-----------	----------

Right

A1051ABR	28-29	Roadster Pickup	Price Set	\$ 79.00
----------	-------	-----------------	-----------	----------

Roadster Pickup Rear Quarter Panel Patches

If the bottom of your '28-'29 Roadster Pickup is rusted away, we have a correct 6" piece with bead. 13 1/2" x 6".



A1050AP	28-29	Price Pair	\$ 35.00
---------	-------	------------	----------

Roadster Pickup Dash Reinforcement Bars

The Steel support Bar that runs between the cowl posts under the dash rail. Ties the cowl Posts Together.



A1005A	28-29	Price Ea.	\$ 99.00
--------	-------	-----------	----------



A1005B	30-31	Price Ea.	\$ 99.00
--------	-------	-----------	----------

Roadster Pickup Dash Rail.

Die stamped steel Roadster Pickup.

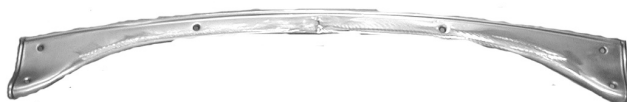

A195A	28-29	Price Ea.	\$ 195.00
-------	-------	-----------	-----------



A1001B	30-31	Price Ea.	\$ 240.00
--------	-------	-----------	-----------

Roadster Pickup Dash Rail Bracket

Open Cars will need to have this Bracket mounted to the Left and Right side of the Dash Bar to Support The Dash Rail. Roadster Pickup. NOT for Closed Cabs.

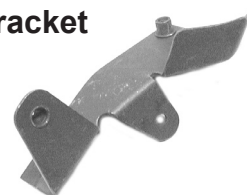

A1001AB	28-29	Price Pair	\$ 45.00
---------	-------	------------	----------



A1013B	30-31	Price Pair	\$ 205.00
--------	-------	------------	-----------

Roadster Pickup Center Brace

This is the Center Brace that goes on the Reinforcement Bar that the Dash Rail fastens to.



RAR219	28-29	Price Pair	\$ 8.95
--------	-------	------------	---------

Roadster Pickup Cowl Post

Includes Cowl Post Bracket A1010AB - See Page P/UP 10. Used on 28-29 Roadster Pickup. For Open Cabs Only.



A1010A	28-29	Left	Price Ea.	\$ 199.00
--------	-------	------	-----------	-----------



A1011A	28-29	Right	Price Ea.	\$ 199.00
--------	-------	-------	-----------	-----------

Mike's "A" FORD-ABLE Parts

Roadster Pickup Cowl Post Patch

This is the 6 1/2" Piece at the bottom of A1010A and A1011A. Open Cabs Only.

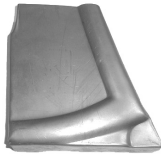

A1010P 28 - 29 Left
 A1011P 28 - 29 Right Price Ea. \$ 37.50

Roadster Pickup Cowl Post Lower Brace

Open Cabs Only.
 6" High x 4 3/4" x 4 7/8".



A1010AB 28-29 Price Pair \$ 39.00

Pickup Dispatch Pockets

This pocket with hardware included mounts on the kick panel on the '30-'31 Closed Cab Pickup.

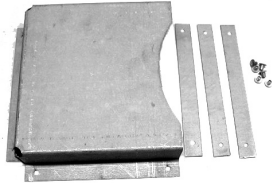

RAR211 June 30- End 31 Price Set \$ 31.00

Pickup Mail Pouch (Dispatch Pockets)

In a complete restoration, you'll need one for each side. They go on the rear corner panel between the door post and cab back. Don't forget to order AWD1282-5 see page P/UP 13.



A890 28-30 Price Pair \$ 25.30



1928-29 OPEN CAB PICKUP (76-A)



1930-31 OPEN CAB PICKUP (76-B)

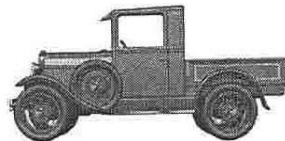

1928-29 CLOSED CAB PICKUP (82-A)



1930-31 CLOSED CAB PICKUP (82-B)

Mr. Brademeyers Fantastic Collection:

1930 Deluxe Roadster, 1928 Huckster, 1931 Fordor Sedan, 1929 Sport Coupe, being hauled by a 1932 Model B Truck.

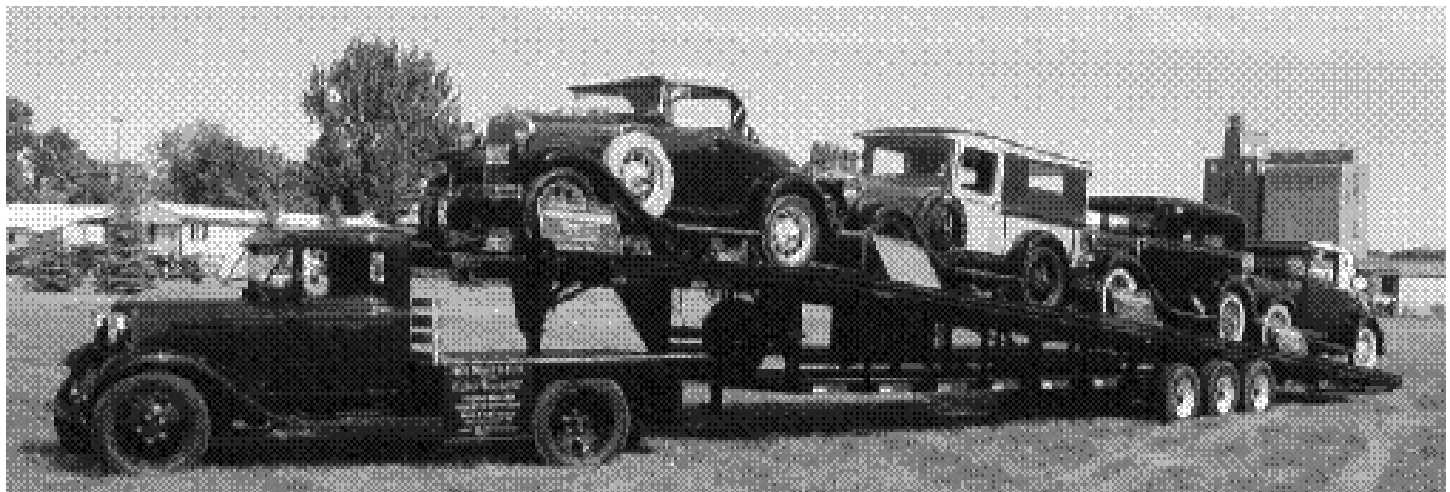

P/UP-10 Give us a call - 1-888-TRY-MIKE (879-6453) **Have an "A" Day!**

PICKUP

SUN VISORS

Closed Cab Sun Visor

Paint Body Color. This is not an exact copy of the original, but it is the best that is made - it does the job.

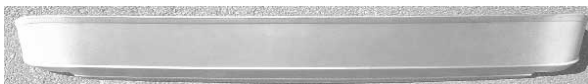

A317BS 30-31 Steel
 Price Ea. \$ 129.00

Closed Cab Visor Welt

This goes between the Sun Visor and the Header and is 4' Long.



A3406VW 30-31
 Price Roll \$ 1.25

Closed Cab Sun Visor Covers

Originally the '28-'29 Sun Visors were covered.
 Closed Cab Only.



For Original Frame - '28-'29

RSV5 Cobra Long Grain
 Price Kit \$ 26.95

For Reproduction Frame - '28-'29

RSV3 Cobra Long Grain
 Price Kit \$ 26.95

Closed Cab Pickup Sun Visor Frame - 46" Long (Reproduction Frame)

This is a steel frame for the sun visor for the '28-'29 Closed Cab Pickup.



Cover kits available separately - above.

A817A 28-29 Visor
 Price Ea. \$ 69.00

Closed Cab Pickup Sunvisor Screw Kit

Oval wood screws and cup washers.
 4 Oval 10-32 x 5/8 metal screws,
 10- #10 x 3/4 Oval Wood Screws
 and 10- #10 cup Washers



A45390 28-29 Price Set/24 \$ 3.45



2-10-32 x 1/4 Flat hd machine scrw
 A45391 30-31 Price Set/2 \$ 0.95

Closed Cab Pickup Panel Above Windshield

This panel fits between the top of the windshield and the cab top on the '28-'29.



A80305 28-29 Price Ea. \$ 77.50

Closed Cab Pickup Panel under Visor

This is the panel that covers the front of the wood header inside the car and is used for the interior panel to set into. Some work may have to be done for a correct fit.

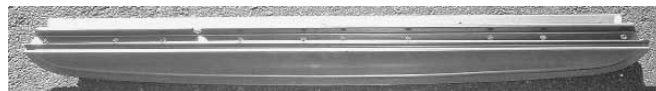

AM753 30-31 Price Ea. \$ 88.00



A Gorgeous 1928 Huckster owned by Mr. B. Brademeyer.

PICKUP

Mike's "A" FORD-ABLE Parts

WOOD

Welcome to Mike's Wood Section. We have a complete selection of wood available for the Roadster Pickup and Closed Cab Pickup, made out of the finest wood available. Each Piece is custom made to fit exactly like it was originally made using top quality hardwoods - oak, ash or poplar. We do not stock these items, they will be shipped directly from the manufacturer - separate shipping charges will apply.

UNFORTUNATELY DUE TO THE AMOUNT OF RETURNS INDIVIDUAL WOOD PIECES ARE NO LONGER AVAILABLE.

***** MIKE'S TIPS *****

If you are having a problem with your Doors, or your Hood will not line up with your Radiator Shell and Cowl - additional Shimming is required, usually under the cowl section. Align the hood first, then work back.

Top Wood - All of the wood from the top of the doors up.

Ribs - These go across the roof and support the top.

Belt Rail - Around the edge of the body where the top meets the body.

Body Wood - Structural Wood inside the body - Does NOT include Chassis wood, Belt Rail or Door wood, unless specified.

Headers - Wood above the windshield - Always included in the Top Wood Kits.

Closed Cab Model A Headers

AWD1025-1	28-29	Deluxe Delivery 130A	
		Price Ea.	\$ 68.00
AWD1033-1	28-29	Pickup & AA 82A	
		Price Ea.	\$ 68.00
AWD1027-1	30-31	Closed Cab Pickup 82B, Deluxe Delivery 130B & All Steel Top Pickup	
		Price Ea.	\$ 89.50

Roadster and Closed Cab Body Mount Blocks

Don't forget to order your Body Block Pads A5000P, A5001P and/or Cowl Shims A5002P

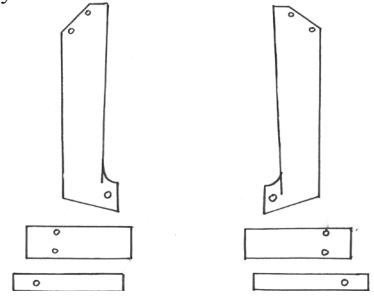

AWD1006 28-29 Pickups Price Set \$ 22.95

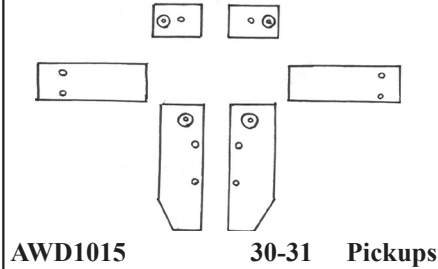

AWD1015 30-31 Pickups Price Set \$ 22.95

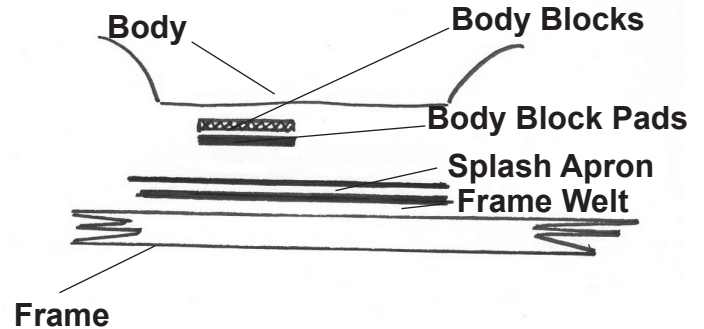

Roadster and Closed Cab Pickup Body, Bed, Box & Frame Mounting Bolt Sets

These complete kits come with complete instructions.



Roadster and Closed Cab Pickup

A90408	28-29	Price Set/34	\$ 8.00
A90409	30-31	Price Set/38	\$ 8.00

Pickup Box to Frame Bolt Set

A90410A	28-31	Price Set	\$ 8.00
---------	-------	-----------	---------

Pickup Belt Rail Bolts

This complete set of carriage bolts, washers, and nuts is used to hold the wooden piece on the back of the inside cab. Bolt heads are on the outside.



A80306	30-31	Price Set/15	\$ 2.50
--------	-------	--------------	---------

PICKUP

Mike's "A" FORD-ABLE Parts

Closed Cab Latch Wood - Door Lock Cover

This is the latch wood that is mounted vertically about halfway up the door post. Originally this was made of hard rubber.



AWD1283-3 30-31 CC Pickups & late '31 Steel Top
Price Pair \$ 15.40

Open Car Cross Bows (Straight Wood Bows)

If your top irons are in good shape but the cross bows are not, you can replace the wood with these.

A42056A 28-29 Roadster Price Set \$ 85.00
A42056C 30-31 Roadster Price Set \$ 88.00

Commercial Top Wood Kits

Includes Header. Everything above the door opening.

AWD1033 28-29 Closed Cab Pickup & AA 82A
Price Kit \$ 283.00
AWD1035 30-31 Closed Cab Pickup & AA 82B
Price Kit \$ 243.00
AWD1036 Late 1931 Closed Cab Pickup -
All Steel Top
Price Kit \$ 200.00
AWD1065 30-31 Sedan Delivery 130B
Price Kit \$ 658.00
AWD1070 28-29 Panel Delivery 79A
Price Kit \$ 980.00

Commercial Wood Kits

Body Shell wood less Top.

AWD1275 28-29 Roadster Pickup 76A
Price Kit \$ 122.00
AWD1298 30-31 Roadster Pickup 76B
Price Kit \$ 59.00
AWD1282 28-29 Pickup & AA 82A
Price Kit \$ 155.00
AWD1283 30-31 Pickup & AA 82B & Late '31
Price Kit \$ 134.00
AWD1265 30-31 Sedan Delivery 130B
Price Kit \$ 672.00
AWD1270 28-29 Panel Delivery 79A
Price Kit \$ 930.00

Roadster Pickup Belt Rails and Tack Rails

These Belt and Tack Rails are included in the Body Wood Kits.

AWD1275-2 28-29 Roadster Pickup 76A
Price Kit \$ 54.00

Misc. Commercial Wood

A965 30-31 Sedan Delivery 130B & Deluxe
Delivery 130B - Rear Floor Wood
Price Kit \$ 393.00



A13735 30-31 Sedan Delivery Dome Light
Wood Block
Price Ea. \$ 12.00

Pickup Mail Pouch (Dispatch Pocket) Blocks

These Blocks are mounted onto the cab corner panels of the '28-'29 Closed Cab Pickup. Pointed side up.



AWD1282-5 28-30 Price Pair \$ 8.50

Roadster and Closed Cab Pickup Seat Frame Wood Kits

AWD1520 28-29 Pickup & AA 82A Seat Back - 4
Pieces (included in body wood
kits)
Price Set \$ 31.00
AWD1521 30-31 Pickup & AA 82B Seat Back - 4
Pieces (included in body wood
kits)
Price Set \$ 44.00
AWD1522 28-29 Roadster Pickup 76A Seat Back -
4 Pieces - included in body wood
Kits
Price Set \$ 31.00
AWD1526 30-31 Roadster Pickup 76B Seat Back -
3 Pieces - included in Body Wood
Kit
Price Set \$ 20.00

Closed Cab Pickup Wood Kit Bolt Sets

Complete Bolt set for wood sets.

Closed Cab Pickup Top Wood Bolt Set

72 Piece Set
AWD-1033-KIT 28-29 Price Set \$ 13.95

Closed Cab Pickup Top Wood Bolt Set

255 Piece Set
AWD-1035-KIT 30-31 Price Set \$ 23.95

For Body Nails - See Page Gen. 34.

Tires & Spare Tires

There is a complete Tire Section See Page Gen. 36 and a complete Spare Tire Section See Page Gen. 39 if you cannot find an item here.

600 x 20 Denman Tire for AA and TT Trucks

This is the same as the 30 x 5 tire. Normally used on the AA and TT Trucks - Blackwall. See **A1025C** for Rim Flaps & **A150620** for tubes (below). See Page Gen. 36 for more tires.



D6020BW 1919-1931 Price Ea. \$ 152.00

Truck Rim Flaps

4 Inches of extra wide protection. See Page Gen. 36 for more liners and flaps.



A1025C 20" AA Truck Price Ea. \$ 20.75

Truck Inner Tubes

Rubber stemmed tubes cost less both on the tube and due to the fact that you don't need additional hardware. See Page Gen. 37 for more tubes.



A150620 20" Rubber Stem Tube - AA Truck Price Ea. \$ 29.95

Spare Wheel Fender Wells

Good heavy steel, these are wells that get welded into fender.

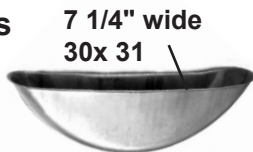

A16029 28-29 Price Ea. \$ 33.95

A16031 30-31 Price Ea. \$ 31.95

Side Mounted Spare Tire Carrier

Used right or left side. Original style with frame plate. Use same brackets Right and Left, on '28-'29 only. Plates Included. 2 Piece Set.

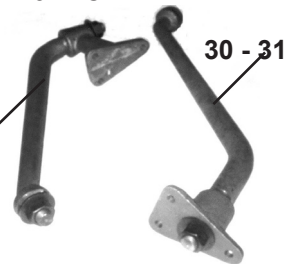

A1405AR	28-29		Price Set/2	\$ 34.95
A1406A	30-31	Driver Side	Price Set/2	\$ 34.95
A1406B	30-31	Passenger side	Price Set/2	\$ 34.95

Spare Tire Plates Only

When you have the arm, we have the plate.....

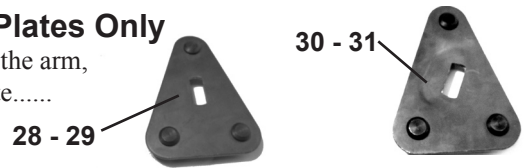

A1406APL	28-29		Price Ea.	\$ 12.95
A1406BL	30-31	Driver - Left	Price Ea.	\$ 12.95
A1406BR	30-31	Passenger - Right	Price Ea.	\$ 12.95

Spare Wheel Side Mount Hardware

These are included when you purchase **A1405AR, A1405A or B. 2 x 5/8 - 18 Nuts, 2 Cotter Pins & 1 Flat washer.** Cotter Pins are only used on Original Arms.



A1405X 28-31 Price Set/5 \$ 2.50

Spare Wheel Side Mount Bracket Bolts

A set of 3 drilled bolts and 3 castle nuts to mount spare tire bracket to frame. **3 x 5/16 - 24 x 1" Cross drilled bolts & 3 castle nuts.**



A1405MB 28-31 Price Set/6 \$ 3.15

Spare Wheel Side Mount Bracket Rivets

Set of 3 rivets. Rivets were originally used, but now commonly replaced by **A1405MB.** Rivets still available.



RA1004 30-31 Price Set/3 \$ 1.50

Spare Wheel Side Mount Grommet

Place in splash shield to fill hole between spare tire and shield. Grommet is not painted.



A1410G 28-34 Price Ea. \$ 1.35

PICKUP

Rear Fenders & Brackets

As Front Fenders & Braces are generic to all Model A's they are still in there own Section - See Page Gen. 199 & 200 For Front Fenders

Open and Closed Cab Rear Fenders Please read carefully before purchase.

Fiberglass Fenders - A complete line of fiberglass fenders are available. These are all hand laminated with fiberglass matte and special resins to achieve the optimum in strength.

Please Note: Additional shipping will apply due to large boxes. These are special orders, please allow three to four weeks for delivery. **Rear fenders will be shipped by courier and are charged according to the box size.**

Steel Fenders - It is important when fitting sheet metal to your car to FIRST fit before painting or drilling any holes. Many times it is necessary to use C-Clamps, vise grips or a drift pin to locate holes for alignment. In order to secure a proper fit and alignment, it is normally necessary to loosen all attaching sheet metal parts. Some reworking may be necessary as mating parts many come from different suppliers or new parts versus 80 year old parts are placed together. Some metal parts may have been treated with oil or may still have residue from forming oils. It is necessary to thoroughly clean the metal with a metal prep or solution to remove all oils and / or fingerprints before painting.

NO RE-WORKED, RUSTED OR PAINTED FENDERS ARE ACCEPTABLE FOR RETURN.

Fiberglass Fenders:

1928 - 1929 Roadster & Closed Cab Pickup Rears

F16161A	Left	Price Ea.	\$ 199.00
F16160A	Right	Price Ea.	\$ 199.00

1930 - Early 1931 Narrow Box Pickup Rears

F16161B	Left	Price Ea.	\$ 199.00
F16160B	Right	Price Ea.	\$ 199.00

Steel Fenders:

These are very well-made reproductions using the same gauge steel as Ford used. They fit the **Roadster and Closed Cab Pick-Up.** Please read the instructions above. **NOT FOR THE WIDE BED PICKUP. SOLD IN PAIRS ONLY.**



A16160/61A	28-29	Left & Right	Price Pr.	\$ 560.00
A16160/61B	30-31	Left & Right	Price Pr.	\$ 560.00

Roadster and Closed Cab Rear Fender Bracket Bolts

Pickups with narrow Box, fender Brace Bolts. 1928 - May 1931.



4 5/16-24 x 4 1/2" Bolts, flat Washers, l/w, and nuts.

A16181C	28-31	Price Set	\$ 3.25
---------	-------	-----------	---------

Roadster and Closed Cab Rear Fender Bracket

Here are the pressed steel rear fender brackets for the Pickups.



A16180A	28-31	Price Ea.	\$ 24.70
---------	-------	-----------	----------

Rear Fender Bracket

This is a good quality pressed steel bracket for the late '31 Wide Bed Pickup Truck.



A16180WB	1931	Price Ea.	\$ 24.70
----------	------	-----------	----------

Rear Fender Mount Studs

These are the special oversized head bolts that get welded or brazed to the body to mount the rear fenders on.



A081MB	28-31	4 studs needed per fender	Price Ea.	\$ 0.50
--------	-------	---------------------------	-----------	---------

Fender Welt

Mike has this 17 foot roll of the 3/16" black beading used on the fenders.



A3404FW	28-31	Price Ea.	\$ 9.90
---------	-------	-----------	---------

PICKUP

Mike's "A" FORD-ABLE Parts

HOOD

Hood Handle

These are pressed steel handles which mount in the middle of the side panels to lift the hood.

Rivets Included.

Use Rivet Tool **RA2022** on Page Gen. 28.

A16609 28-31 Price Pair \$ 24.95



Comes with **A16755** Modern Rivet Style

A16609SS 28-31 Stainless Price Pair \$ 30.75

Hood Latch Brackets

This is a complete set of brackets and hardware that the hood latch hooks onto. Use rivets **A16753**.

If you are using rivets, use Rivet Tool **RA2022** on Page Gen. 28.

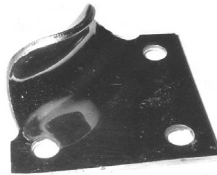

A16750CL 28-31 Price Set/16 \$ 4.95

Comes with **A16753** Original Rivets, or you can order **A16755** Modern Style separately.

A16750HCSS 28-31 Stainless Price Set/16 \$ 12.05

Hood Handle & Latch Clip Rivet Set

Original style rivets for the hood handles and clip brackets. Use **RA2022** Rivet Tool on Page Gen. 28.



A16753 Price Set/20 \$ 2.00

Modern Style Hood Handle & Latch Clip Screw Set

These screws are used on the Hood Handles and Hood Clips - not original.

These are stainless round head screws with nuts that look like rivets from the outside. No riveting needed!!



A16755 Price Set/20 \$ 4.95

Hood Prop Kit

These stainless steel props are an important add-on for safety. The kit bolts onto the radiator braces and the fold out arms are rubber-coated to rest the hood on.

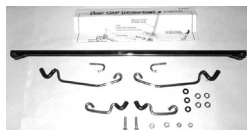

A16613SS 28-31 Price Kit \$ 24.95

Hood Safety Supports

Mounts on the hood rods, and hooks to hood rod bracket on firewall. When you raise the hood, set the bottom edge of the hood on the hooked end of the arm - protective plastic covers the wire. Set includes left and right side wire. Instructions included.



A16714A 28-29 Price Set \$ 21.95

A16714B 30-31 Price Set \$ 21.95

Early '28 Hood (All Early '28 Cars)

The early '28 hood louvres were all the same length. From mid '28 the top of the louvres on the side had a slight taper. Trophy Quality. Paint Underside Lower Body Color. Includes Handles **A16609** and Hood Clip Brackets **A16750CL** and Steel Hood Rods.



A16610AR 1928 Price Ea. \$ 405.00

1928-29 Stock Hood

This hood fits the '28-'29 Model A's. Trophy Quality. Paint Underside Lower Body Color. Includes Handles **A16609** and Hood Clip Brackets **A16750CL** and Steel Hood Rods.

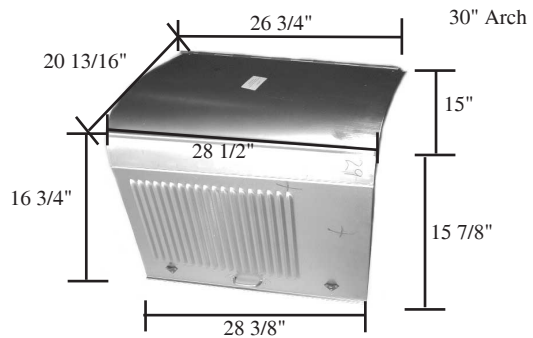

A16610A 28-29 Price Ea. \$380.00

1930-31 Stock Hood

All the '30-'31 Model A's used this hood. Trophy Quality. Paint Underside Lower Body Color. Includes Handles **A16609** and Hood Clip Brackets **A16750CL** and Steel Hood Rods.

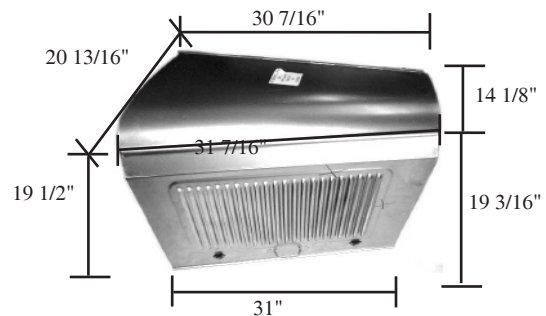

A16610B 30-31 Price Ea. \$ 420.00

PICKUP

Mike's "A" FORD-ABLE Parts

Stainless Hood Rods

Complete set of three hood rods. After punching these rods out about 1", use a variable speed drill, chuck it to the rod and spin the rod as you pull it out.



A16611A	28-29	27 3/4" Long		
			Price Set/3	\$ 14.95
A16611B	30-31	30 1/2" Long		
			Price Set/3	\$ 14.95

Hood Corners

Triangle leather hood corners originally were on the rear only. Use Rivet Tool RA2022 on Page Gen. 28. Rivets to be painted black.

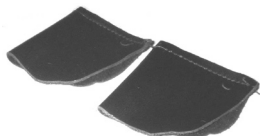

A16622LS	28-31	9/64 x 5/16 tubular rivets		
			Price Pair	\$ 3.90

Hood Corners

These are molded rubber hood corners; look good. Use Rivet Tool RA2022 on Page Gen. 28



A16622RS	28-31		Price Pair	\$ 3.90
----------	-------	--	------------	---------

Hood Shelf

Not used on 1930-1931.

See diagram on page P/UP 18. Don't forget A16727S Blocks.



A16713/14	28-29		Price Pair	\$ 33.95
-----------	-------	--	------------	----------

Hood Shelf Blocks

These wooden blocks go under the hood shelf. They act as spacers to mount the hood latch.

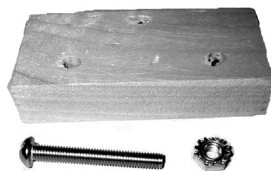

A16727S	28-29		Price Set/40	\$ 6.75
---------	-------	--	--------------	---------

Center Hood Bracket

Attaches to the frame with rubber bumper (A16761B - See Page P/UP 20) against the hood to prevent rattles.



A16718S	30-31		Price Set/12	\$ 5.50
---------	-------	--	--------------	---------

Hood Retainer (Front)

The center hood rod hooks onto this clip on the radiator shell. Paint Black



A8220C	28-31		Price Ea.	\$ 3.15
--------	-------	--	-----------	---------

Hood Retainer Mount Set (Front)

A pair of tube rivets to mount the center hood rod brackets. Use Rivet Tool RA2022 Page Gen. 28.



A8220MB	28-31		Price Pair	\$ 0.50
---------	-------	--	------------	---------

Hood Rod Retainer (Rear)

This is the rear retainer for the hood. Paint body color.



A16735A	28-29		Price Ea.	\$ 5.10
---------	-------	--	-----------	---------

Standard Hood Hinge Rod Retainer (Rear)

Same as above but for different years. Paint body color.



A16735B	30-31		Price Ea.	\$ 4.95
---------	-------	--	-----------	---------

Deluxe Hood Hinge Rod Retainer (Rear) Chrome

This serves the same purpose as A16735B, but has a finger which clamps over the cowl band. Normally only used on Deluxe '30-'31 Models. Order A16735BMB Screws - below.



A16735C	30-31		Price Ea.	\$ 8.75
---------	-------	--	-----------	---------

Retainer Mounting Screws (Rear)

Screws to mount the rear hood retainer to the firewall.



A16735AMB	28-29	2 x 12-24" x 5/8" round head	Price Set/6	\$ 0.95
-----------	-------	------------------------------	-------------	---------



A16735BMB	30-31	2 x 12-24" x 5/8" flat head	Price Set/4	\$ 0.95
-----------	-------	-----------------------------	-------------	---------

INSTALLATION OF HOOD SHELF FOR 1928 - 1929 ONLY

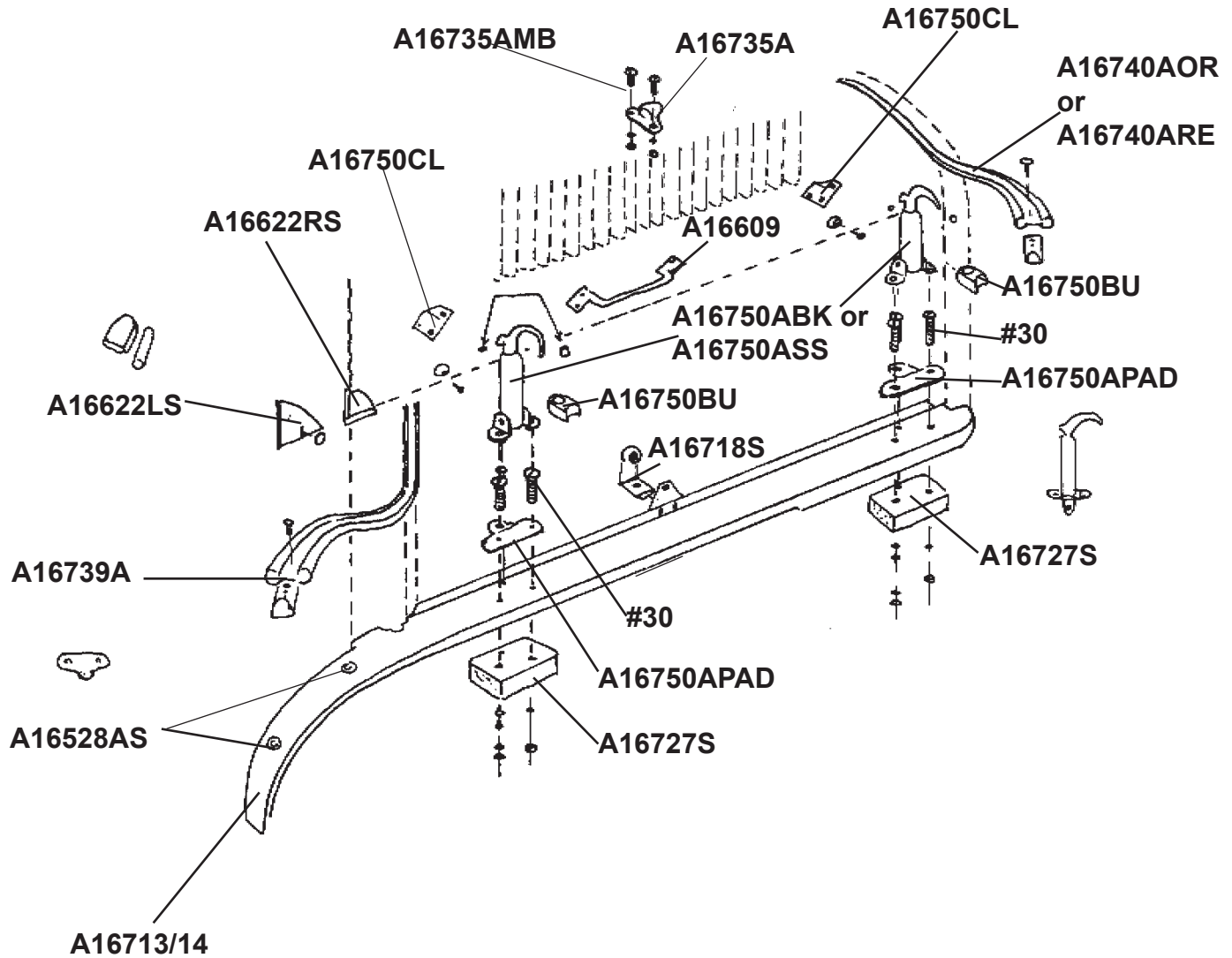

PICKUP

Mike's "A" FORD-ABLE Parts

Hood Retainer Shims

Having alignment problems with your hood? Place these steel shims between the rear hood retainer and the cowl.
Will help if the bottom of the hood is hitting on the radiator shell.



A16736A	28-29	Price Ea.	\$ 0.55
A16736B	30-31	Price Ea.	\$ 0.60

Cowl Band

This is a well made stainless steel reproduction. These '30-'31 reproduction bands will not fit the '28-'29's. These were usually painted black on all Commercial Trucks.

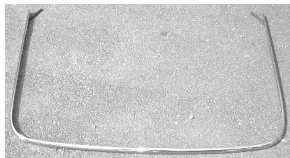

Special box for UPS - additional shipping charges do apply.

A16737CB	30-31	Price Ea.	\$ 73.00
----------	-------	-----------	----------

Cowl Band Clips

These clips go under the cowl panel screws on the firewall and slip under the cowl band to hold it in place.



A16738CL	30-31	Price Pair	\$ 3.35
----------	-------	------------	---------

Radiator Shell Lacing

This is a double beaded lacing for the radiator shell, comes with raven rivets.



A16739A	28-29	Price Set/25	\$ 6.75
---------	-------	--------------	---------

A16739B	30-31	Price Set/25	\$ 9.00
---------	-------	--------------	---------

Cowl Lacing Hook

This is the special hook that the wire attaches to, to hold the cowl lacing on.
10-32 x 3/4" Special Clamp Screw
Used with original A16740AOR.
Not included in lacing Kit A16740ARE or AOR.



A16739AC	28-29	Price Set	\$ 1.95
----------	-------	-----------	---------

Cowl Lacing Kit & Rivets

Two types are available for the '28-'29 A's. The original used wire to hold the lacing down on the gas tank and rivets on the cowl panels.
Use Rivet Tool RA2022 on page Gen 28.



A16740ARE	28-29	Replacement	Price Kit	\$ 8.60
-----------	-------	-------------	-----------	---------

A16740AOR	28-29	Original	Price Kit	\$ 12.75
-----------	-------	----------	-----------	----------

Cowl Lacing Screws

Special pan headed replacement screws for installing the '30-'31 cowl lacing. Included in the cowl lacing kit (A16740BS). One for each side and the third top center. 3 12-24 pan head screws



A16740MB	30-31	Price Set/3	\$ 0.75
----------	-------	-------------	---------

Authentic Cowl Lacing Kit

Just like the original for '30-'31 A's. Complete with all clips, screws, and rivets.
Use rivet Tool RA2022 on page Gen. 28.



A16740BS	30-31	Price Kit/10	\$ 15.45
----------	-------	--------------	----------

1930-31 Cowl Lacing Clip

Replacement clips for the '30-'31's if you've lost some. Included with kit A16740BS.

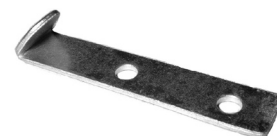

Use Rivet Tool RA2022 on page Gen. 28.

A16737	30-31	Price Ea.	\$ 0.75
--------	-------	-----------	---------

Cowl or Radiator Rivets

This is a package of 24 raven-finished split rivets to attach the hood lacing.



A16745	ANY	Price Set/24	\$ 1.20
--------	-----	--------------	---------

Hood Latch Repair Kit

If possible try to repair your original latch handles. Our set does all 4 latches and comes with complete instructions.



A16749	28-31	Price Set/12	\$ 12.50
--------	-------	--------------	----------

Hood Latch Handle

We have both the original black three-hole handles as well as stainless steel.



A16750ABK	28-29	Black	Price Ea.	\$ 8.25
-----------	-------	-------	-----------	---------

A16750ASS	28-29	Stainless - 3 Hole Mounting	Price Ea.	\$ 11.00
-----------	-------	-----------------------------	-----------	----------



#30	28-29	Hood Handle Screws	Price Set/36	\$ 2.25
-----	-------	--------------------	--------------	---------

Give us a call - 1-888-TRY-MIKE (879-6453) **Have an "A" Day! P/UP-19**

PICKUP

Mike's "A" FORD-ABLE Parts

Hood Latch Pads

These 4 rubber pads go under the hood latches.



A16750APAD 28-29 Price Set/4 \$ 4.10



A16750BPAD 30-31 Price Set/4 \$ 4.10

Hood Latch Handle

We have both the original black two-hole handles plus modern stainless steel.



A16750BBK 30-31 Black Price Ea. \$ 8.25

A16750BSS 30-31 Stainless - 2 Hole Mounting Price Ea. \$ 11.00



#32 30-31 Hood Handle Screws Price Set/24 \$ 2.25

Hood Latch Rivet Kit

These tiny rivets connect the body of the hood latch to the mounting bracket. Use Rivet Tool RA2022 on page Gen. 28.



A16751 28-31 Price Set/4 \$ 0.50

Hood Latch Caps

This set of 8 rubber caps protects your finish from being scratched. 1 Set will do all four handles.



A16750CS 28-31 Price Set/8 \$ 1.45

Hood Latch Bumper

Set of 4 rubber bumpers that fit over the hood latch stem to reduce rattles. This Latch bumper set cannot be used if you are using the Hood Bumper Set A16761 or A16761B.



A16750BU 28-31 Price Set/4 \$ 3.00

Hood Bumper Set

Complete set of 6 round rubber hood bumpers with rivets. Four for the hood and two for the centre hood braces. Place one under each hood clip plus one on each support clip. Use Rivet Tool RA2022 on page Gen. 28.

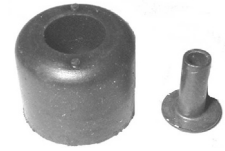

A16761 28-31 from Aug 28 to May 31 Price Set/12 \$ 3.50

Hood Bumper Set

Complete set of 2 round rubber bumpers for the inside center support plus 4 triangular ones to go under each hood clip. The supplier ships with rivets which is correct, but Mike recommends using rivet head screws and nuts to keep them in place.



A16761B 1931 May 31 'til end Price Set/12 \$ 3.75



PICKUP

MUFFLER

For more Muffler related items see page Gen. 95 in our Running Chassis section.

Tail Pipe Extension



In 1931 the Ford Service Bulletins suggested the installation of an extended tail pipe on all Station Wagons to avoid fumes in the rear seats. An authentic reproduction of this tail pipe, including the special spring clamp / hanger and the special pipe clamps. These extension were used on **Station Wagons, Panel Delivery's and the AA Panel Trucks, Moving Vans, Buses, etc.**

A5230EXT 1931 Price Set \$ 89.00

REAR SPRING

For more spring related items see page Gen. 98 in our Running Chassis section.

Roadster & Closed Cab Rear Leaf Spring

A good reproduction of original.
For clamps, bushings, Spring Bolts,
U Bolts & Nuts see Page
Gen. 99 & 100.



A5560A 10 Leaf 28-31 Price Ea. \$ 225.00

RADIATOR SHELL

For more Radiator items see Page Gen. 134 in our General / Running Chassis section.

Roadster and Closed Cab Radiator Shells

These are imports. The '28 and '29's are plated steel and are pretty good. Hood hinge clip is included. **NOT included** is A8200AS Screws (Page Gen. 136), A8210AS Grommet (Page Gen. 136), A8212A Emblem (Page Gen. 135), A16739A Lacing (Page Gen. 135) & A8216A Crank Hole Cover (Page Gen. 137).



A8200A	28-29	Primed - Black for Commercial Use	Price Ea.	\$ 115.00
A8200C	28-29	Chrome - Not original but available as a second choice	Price Ea.	\$ 149.95

For '30-'31 try and find a good used shell and paint black.

RUNNING BOARDS

For more Running Board items see Page Gen. 206 in our General / Running Chassis Section.

Roadster & Closed Cab Commercial Running Boards

Super Quality. These are the diamond design boards made from 16 guage steel.

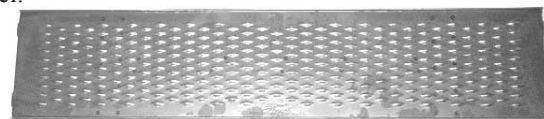

AM202	28-29	Ford Script	Price Pair	\$ 190.00
AM203	30-31		Price Pair	\$ 190.00

PICKUP TRUCK BED

Pick-Up Bed Less Tailgate

This is a complete pickup bed, already assembled and ready to paint and install. Add \$250 for crating. Shipped by truck. This item is drop shipped from the manufacturer. See **Page P/UP 2** for diagram. See **A952AB** for Tailgate.

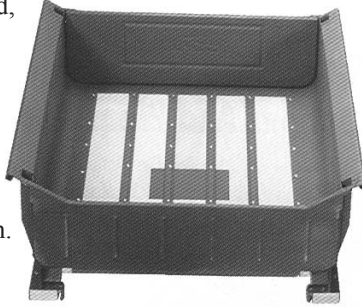

A975ABNS 1928 - Mid 1931 Price Ea. \$1625.00

Pick Up Truck Bed (Un-assembled) Includes Tail Gate

Mike also can supply this complete Un-assembled bed for the DIYers who want to know how everything fits together. This has all the metal pieces plus floor wood for the narrow bed used through **May of 1931**. **Can be shipped UPS**. This item is drop shipped from the manufacturer. When purchasing an un-assembled bed, you will need Rivet Tools - See page **Gen. 27**.

A975UN 28-31 Price Ea. \$1300.00
A975BRB Boxing Chg. \$ 35.00

Pickup Bed Sides

These truck bed sides are ready to paint and attach. Sides ONLY - no attaching parts.



A950ABNS 28-31 Price Pair \$ 440.00

Pickup Bed Panel

This bed panel fits between the cab and the bed and bolts to the frame. The lip sticks up between the bed rails. **4 1/2" Lip x 35" Long, x 7" Wide.**



A878 28-31 Price Ea. \$ 45.00

Pickup Tailgate

This is an excellent tailgate! Has the Ford script and all mounting brackets.



A952AB 28-31 Price Ea. \$ 235.00

Pickup Front Bed Panel

The top corner tabs are already installed on this quality reproduction panel.



A871S 28-31 Price Ea. \$ 92.00

Pickup Z Shaped Panel

This panel goes on top of the rear U Channel and provides the base for the wood to sit on.

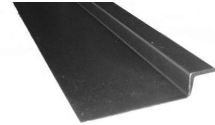

A959A 28-31 Price Ea. \$ 33.00

Pickup Rear Fender Spacers

These spacers go between the rear fenders and the bed. Requires 5 Rivets per side, and 2 for Bed Strip (**A873 or SS - See Page P/UP 24**) to Center Bed Plate (**A872 - See Page P/UP 24**).

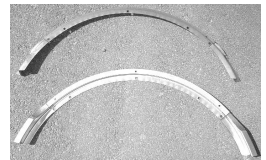

A958AB 28-31 Price Pair \$ 105.00



A65028 Rivets - 3/16 x 3/8 Price Set/12 \$ 2.75

Pickup Bed Sub-Rails

These are the metal subrails that attach to the frame for the bed. Wood sills are attached to these.

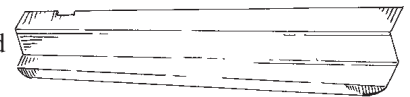

A951ABNS 28-31 Price Pair \$ 160.00

Pickup Bed Sub Rail Brackets

You'll need two of these to attach to the subrails and support the wooden bed sills **A970AB - See Page P/UP 23**.



A973AB 28-31 Price Pair \$ 39.95

PICKUP

Mike's "A" FORD-ABLE Parts

Pickup Bed Rivets

This is a complete set of rivets to put your bed together. Different lengths are included.



A971AB 28-31

Price Set/103 \$ 10.00

Pick-Up Bed To Frame Bolts

This is a complete set of bolts to attach the bed to the frame. Not for Wide Beds.

For Cab to Frame Bolts See Page P/UP 12.



Pickup Box to Wood Sill Bolts

A90410A 28-31

Price Set \$ 8.00

Pickup Bed Wood Sills

These hardwood bed sills go between the bed and the frame, one per side.

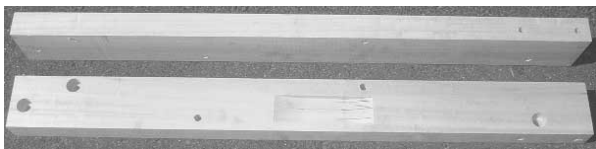

A970AB 28-31

Price Pair \$ 52.00

Pickup Cross Channels

This set of cross channels run across the width of the truck under the bed. 1 Set Required.



A953AB 28-31

Price Set \$ 74.50

Pickup Rear U-Channel

This channel serves for both the tailgate brackets to hook to and for rear stake pockets.



A955AB 28-31

Price Ea. \$ 220.00

Pickup U-Channel Repair Kit

If the rear part of your U-channel is rotted, you can replace the center portion only by welding this in place. Includes the Z panel.



A874

28-31

Price Ea. \$ 45.00

Pickup Front Bed Stake Pockets

This pair of pockets go on the front near the top. Stamped and die formed. See A955AB below for Rear.

Order A65027 (Page P/UP 24) for Rivets.



A976AB

28-31

Price Pair \$ 72.00

Pickup Stake Pocket Covers

You'll need four of these per bed to go on top of the bed sides where the stake pockets are located.

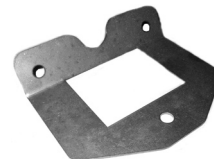

A960AB

28-31

Price Ea. \$ 7.50

Pickup Side Boards

These are good hardwood sideboards for the narrow bed only.



AWD-1235

28-31

Price Set \$ 100.00

Pickup Tailgate Hinge Set

This four-piece set attaches to the rear U-channel for the tailgate hinges to connect to. 4 Pieces.

Order A65027 for rivets.

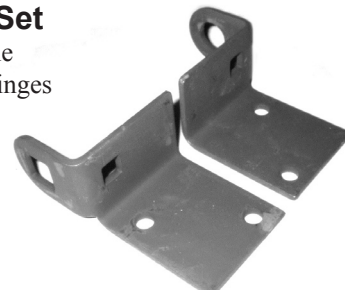

A961AB

28-31

Price Set/4 \$ 20.00

Mike's "A" FORD-ABLE Parts

Pickup Tailgate Hinge Bolt

This special set has the bolt, castle nut, and cotter pin needed for the tailgate.

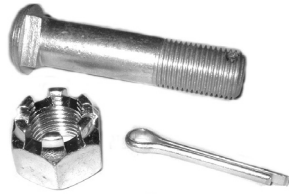

A963AB 28-31

Price Set \$ 6.85

Pickup Bed Box Rivets

24 x 1/4 x 1/2" Rivets - use 2 for each Chain Bracket (A964AB), 3 for each Stake Pocket (976AB) and 4 for each Tailgate Hinge (A961AB).

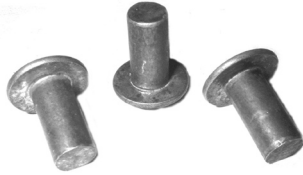

A65027 28-31

Price Set/24 \$ 5.00

Pickup Bed Wood

This hardwood is all pre-cut with grooves for the bed strip. Mike recommends using a good-quality varnish giving it a beautiful finish. 5 Boards in Set.



AWD1225 28-31

Price Set/5 \$ 185.00

Pickup Center Bed Plate

This heavy steel plate goes in the center of the bed over the rear spring. Order A65028 (Page P/UP 22) for rivets.

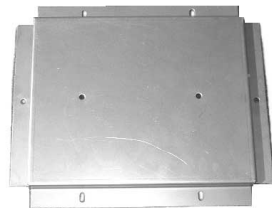

A872 28-31

Price Ea. \$ 27.50

Pickup Bed Strips

These bed strips are available in both plain and stainless steel. Order A65028 (Page P/UP 22) for rivets.



A873 28-31 Steel - Paint Body Color
Price Set/4 \$ 51.00

A873SS 28-31 Stainless
Price Set/4 \$ 75.00

Pickup Bed Floor Mounting Bolts

This kit has all the carriage bolts, nuts, and special square washers needed to attach the bed to the bed strips. 10 Square flat washers & 10 round washers.

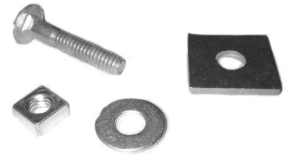

A969AB 28-31 Price Set/44 \$ 13.95

Original Nut for Bed Mounting Bolts

For the show cars, this is the correct nut for the A969AB. Original 1/2" wide 1/4-20 thread 1/4" thick nut.



A33890 28-31 Price Set \$ 15.40

A964AB - Chain Bracket

A966AB - Lock Link

A965AB - Chain Hook

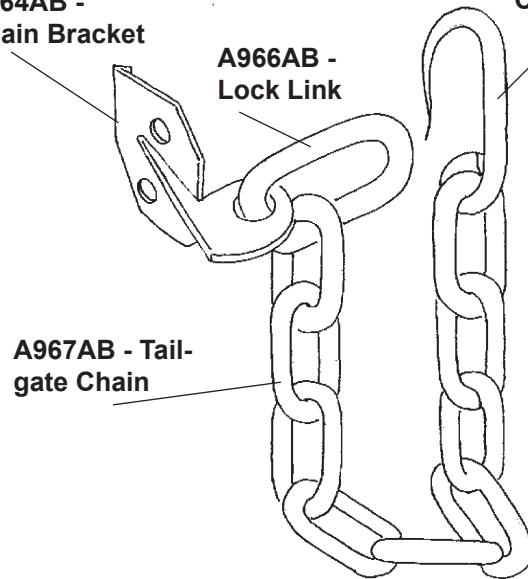

A967AB - Tailgate Chain

Pickup Chain Brackets

These attach to the bed for the lock links to connect to. 2 Needed.

Order A65027 for Rivets.



A964AB 28-31

Price Ea. \$ 12.00

Pickup Lock Link

Lock links connect the chain A967AB (Page P/UP 25) to the bracket A964AB above. 2 Needed.



A966AB 28-31

Price Ea. \$ 3.45

PICKUP

Mike's "A" FORD-ABLE Parts

Pickup Tailgate Chains

These chains support the tailgate when you let it down. 2 Needed.
16 Links.



A967AB 28-31 Price Ea. \$ 5.00

Pickup Chain Hook

These connect the chain to the tailgate.
2 Needed.



A965AB 28-31 Price Ea. \$ 6.00

Pickup Chain Covers

These covers slide over the chains to prevent paint chipping and rattling. 2 Needed.



A962AB 28-31 Price Ea. \$ 5.00

1928 Roadster Pickup owned by Mr. & Mrs. B. Bohanan



Give us a call - 1-888-TRY-MIKE (879-6453) **Have an "A" Day!** P/UP-25

Mike's "A" FORD-ABLE Parts

ROADSTER PICKUP WINDSHIELD

1928 - 1929 Roadster Pickup Windshield Components

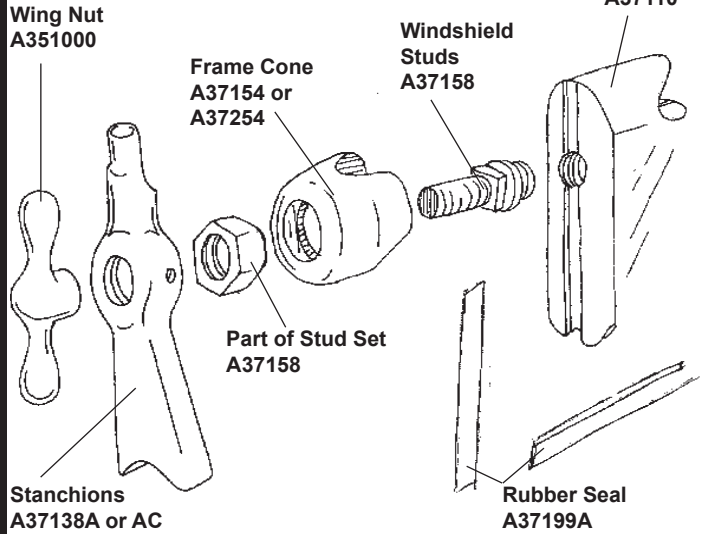

Roadster Pickup Windshield Frames

These frames are for the open car only. They are made from round tubing and can be bought in plain finish to be painted or in chrome. Order the Frame Gasket A37199A for '28-'29 or A37199B '30-'31.



'28 - '29	14 5/8"			
'30 - '31 Std	15 1/4"	- Stanchions	13 1/2"	
'30 - '31 Dlx	13 1/2"	- Stanchions	12 1/8"	
A37110AP	28-29	Plain		
			Price Ea.	\$ 210.00
A37110AC	28-29	Chrome		
			Price Ea.	\$ 370.00
A37110BPS	30-31	Standard Plain		
			Price Ea.	\$ 205.00
A37110BCS	30-31	Standard Chrome		
			Price Ea.	\$ 370.00
A37110BPD	30-31	Deluxe Plain		
			Price Ea.	\$ 205.00
A37110BCD	30-31	Deluxe Chrome		
			Price Ea.	\$ 370.00

Roadster Pickup Glass Bedding

The correct cork / neoprene bedding used for setting glass into the windshield frame.



A3402X	28-31	Price Ea.	\$	7.50
--------	-------	-----------	----	------

Roadster Pickup Windshield Gasket Set

This set of rubber gaskets is used on the open car windshield. Enough for sides and bottom of frame.



A37199A	28-29	Price Set	\$	4.50
A37199B	30-31	Price Set	\$	4.75

Roadster Pickup Windshield Stanchion

Sold in pairs, these stanchions are authentic stamped steel reproductions for the Roadster Pickup. Has sockets and liners installed. Deluxe Length 12 1/2" Standard Length 13 3/8".



A37138A	28-29	Plain	Price Pair	\$ 195.00
A37138AC	28-29	Stainless	Price Pair	\$ 215.00

Roadster Pickup Windshield Stanchions

For the Roadster P/Up, use these regular steel stanchions which can be painted as original. Has sockets and liners installed.



A37138PST	30-31	Plain Steel	Price Pair	\$ 275.00
-----------	-------	-------------	------------	-----------

Mike's "A" FORD-ABLE Parts

Roadster Pickup Stanchion Horns

Open Cabs will need to have this bracket mounted to the left and right side of the dash bar to support the dash rail. Not for Closed Cab Pickups.



A1001AB 28-29 Price Pair \$ 45.00



A1013B 30-31 Price Pair \$ 205.00

Roadster Pickup Lower Stanchion

Mike also has these pressed steel stanchions for the Standard and Deluxe Roadster Pickups. Sold in pairs. For Dash Rail Brackets see Page P/UP 9.



A37130ST 30-31 Plain Price Pair \$ 130.00



A37130STC 30-31 Stainless Price Pair \$ 277.50

Roadster Pickup Stanchion Spacer

This pair of lead spacers are molded joined, so you'll have to break them apart. The spacer fits between the dash rail and the stanchion.



A371301 30-31 Price Pair \$ 8.10

Roadster Pickup Stanchion Screws

Each set of 4 screws is correct for the years indicated. 1928-1929 used 5/16-18 oval head screws. 1930 used a 5/16-24 oval head screw. 1931 used a 5/16-24 Hex head screw with a screwdriver slot. Paint screws body color.



1928 & 29	30	31		
A37135ABR	28-29		Price Set/4	\$ 3.00
A37135BBR	1930		Price Set/4	\$ 5.00
A37135CBR	1931		Price Set/4	\$ 5.20

Roadster Pickup Windshield Post Sockets

This is a steel socket that mounts on the windshield post for the windshield to fit into.



A37137L 30-31 Lower Price Ea. \$ 7.50



A37137S 30-31 Upper Price Ea. \$ 6.45

Roadster Pickup Finger Pulls

These finger pulls were used on the windshield frame of all open cars to pull the windshield shut. Includes 10/32 x 1" # 8 Oval head Screws.



B37118S 28-36 Price Pair \$ 9.35

Roadster Pickup Post Liners

These liners fit into the windshield stanchion on the open cars. These are not needed if a complete stanchion set is bought.

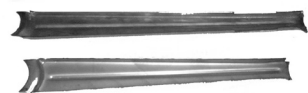

A37138PLS	30-31	Std	Price Ea.	\$ 22.00
A37138PL	30-31	Deluxe	Price Ea.	\$ 14.50

Roadster Pickup Wing Nuts

You'll need 2 of these for your '28-'29 open car or 4 for your '30-'31. All use 2 at the top where the windshield pivots plus the latter use 2 more to attach the upper and lower stanchions.



A351000 28-31 Price Ea. \$ 2.85

Mike's "A" FORD-ABLE Parts

Roadster Pickup Wing Nut Washers

These stainless steel washers go between the wing nut and the stanchion. 4 per set.



A351000BR 28-31 Price Set/4 \$ 1.15

Roadster Pickup Frame Cones

This cone is used at the pivot point between the windshield frame and the stanchion. Stanchion post upper cups have round slot machined at an angle as original to conform to windshield side angle which is wider at top. The side having the higher or thicker side (from bottom) is installed down. These are not needed if complete stanchions are purchased.



A37154R 30-31 Deluxe - Chrome Price Ea. \$ 5.00
 A37254 28-31 Black - Standard Price Ea. \$ 5.00

Roadster Pickup Windshield Studs

This set of replacement studs are used where the open car windshield pivots. Pair of Studs and Nuts.



A37158 28-31 Price Set \$ 4.95

Roadster Pickup Windshield Fastener Set

This set contains the male studs that screw into the windshield post for the side curtains and the snaps for the top of the windshield where the top attaches.



A37103 28-31 Price Set \$ 20.75

Roadster Pickup Windshield Post Curtain Studs

12 Original type studs made from brass. Nickel plated. 2 Long & 10 Short.



A37160 28-35 Price Set \$ 9.25

Roadster Pickup Windshield Snaps

Brass, Nickel plated for the curtains. Used on original windshield frames. Need 6 per Windshield. Press in Style as original, and screw in 10/32 style available. For a full set see A37103 above.



A37170 28-31 Press-In Price Ea. \$ 2.10

CLOSED CAB PICKUP WINDSHIELD

Closed Cab Pickup Windshield Frame

These windshield frames are good aluminum reproductions of the originals. They come with frame gasket Only - A79501 below. Hinge gasket may be needed - A79550 - See Page P/UP 29.

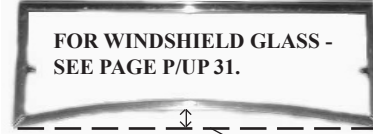

2 3/8" for '30-'31

A45410AR 28-29 16 1/4" High Price Ea. \$ 180.00
 A45410A 30-31 16 1/4" High Price Ea. \$ 180.00

Closed Cab Pickup Show Quality 1928 - 1931 Steel Un-Finished Windshield Frame

This top quality frame comes with the correct swing arm brackets, frame gaskets, and assembly tools. Right Hand drive is available upon request. Some sanding required.



28-5410U 28-29 Price Ea. \$ 445.00
 30-5410U 30-31 Price Ea. \$ 445.00

Closed Cab Pickup Glass Bedding

The correct cork / neoprene bedding to be used for setting the glass in the windshield frame.



A3403X 28-31 Price Roll \$ 7.50

Closed Cab Pickup Windshield Frame Gasket

This gasket goes on the bottom (put in first) and sides of the steel windshield frame. Rubber gaskets stretch when you install them so wait a day to trim for a tighter fit.



A79500 26-31 Price Ea. \$ 3.50

Closed Cab Pickup Windshield Frame Gasket (Reproduction Aluminum Frame)

For the aluminum frame, this is the gasket to use. This does the bottom and both sides but wait a day to trim because of stretch.



A79501 28-31 Price Ea. \$ 4.15

PICKUP

Mike's "A" FORD-ABLE Parts

Closed Cab Pickup Windshield Hinges

These aluminum hinges for the closed car have to be drilled out and have tapers cut on the ends.



A45411AR 28-29 Price Ea. \$ 11.30
A45411A 30-31 Price Ea. \$ 11.30

Closed Cab Pickup Windshield Hinge Gasket

This gasket is critical to keep out water. It fits between the windshield hinge and the header. The small round edge is exposed to the outside.



A79550 28-31 Price Ea. \$ 3.00

Closed Cab Pickup Windshield Frame Screws

When you need to replace the glass in your windshield you should take this opportunity to replace the screws in your windshield frame.



#47 28-31 Price Set/8 \$ 2.00

Closed Cab Pickup Windshield Bracket

This bracket is an exact duplicate of the '28-'29 originals. Includes rivets. These brackets are included with a new windshield frame.



A45471A 28-29 Price Ea. \$ 9.95

Closed Cab Pickup Windshield Bracket

This bracket is an exact duplicate of the '30-'31 originals. Includes Rivets. These brackets are included with a new windshield frame.



A45471B 30-31 Price Ea. \$ 9.95

Closed Cab Pickup Windshield Hinge to Header Screws

A complete set of screws to attach the hinges to the header on the Closed Cabs.



A30200 28-29 6 1/4-20 x 1/2" round head screws, 4 10/32 x 3/8 flat, 2 10/32 x 1/2 Oval & 2 3/8 x 10/32 square Nuts. Price Set \$ 1.80

A30210 30-31 10 - #10 x 1" round head wood screws Price Set \$ 1.00

Closed Cab Pickup Windshield Hinge Screws - Interior

5 - #10 x 3/4" flat head wood screws attach to the inside of the windshield to secure the Windshield hinge to the header.



A30220 28-31 Price Set \$ 0.50

Closed Cab Pickup Windshield Header Brackets

Use this metal bracket to connect the wood header to the side wood body rail.

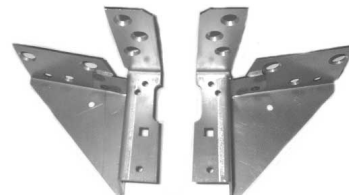

RAR218 30-31 Price Pair \$ 42.00

Closed Cab Pickup Windshield Header Bracket Screws

8 - 5/16-18 x 2" flat head screws. Two screws go forward into the header and two at a right angle, into the wood side rail.



Also 6 - 12/24 x 5/8" flat head screws and 6 1/4" external, counter sunk lock washers to mount the brace to the vertical top.

A40130 28-31 Price Set \$ 2.75

Closed Cab Pickup Rear Roof Wood Bracket

Connect your side wood rail above the door to the door post with this bracket. Made from Ford blue prints. Need 2. Used from Mid '30 - End on Closed Cab Trucks.



RAR216 Mid 30-31 Price Ea. \$ 17.50

Closed Cab Pickup Rear Roof Wood Bracket Bolts

A complete set of bolts for the RAR216 above. Four 1/4-20 x 1 3/4" carriage bolts, lock washers and nuts. One #12 x 3/4 flat head wood screw.



A83945 Mid 30-31 Price Set \$ 2.45

Mike's "A" FORD-ABLE Parts

Closed Cab Pickup Windshield Garnish

This steel garnish screws to the windshield posts on both sides of the windshield opening on the closed cabs. **Not available for the '28-'29 Closed Cab Pickups.** Use A342S Screws below.

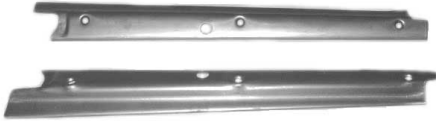

A45483	30-31	Steel - Pickup	Price Pair	\$ 46.50
A45483S	30-31	Stainless - Pickup	Price Pair	\$ 63.25

Closed Cab Pickup Garnish Molding Screws

These screws are 10/32 x 1/2" to attach the garnish molding to the door.



A342S	28-31	Price Ea.	\$ 0.15
-------	-------	-----------	---------

Closed Cab Pickup Filler Trim

This panel goes above the gas tank at the back edge on '30-'31's. The lower part of the windshield closes against this.



BWO-3031-LS	30-31	Price Ea.	\$ 178.00
-------------	-------	-----------	-----------

Closed Cab Pickup Swing Arms

These are the arms that pivot to hold the windshield out for fresh air or close and seal the glass shut - closed cabs.



A45463S	28-31	Price Pair	\$ 9.95
---------	-------	------------	---------

Accessory Style Swing Arms

These arms have notches in them so that the arms are sure not to move or slide. Once you use these you'll be hooked.



A45463N	28-31	Price Pair	\$ 29.95
---------	-------	------------	----------

Closed Cab Pickup Windshield Frame Nut

This is the special nut that goes on the windshield frame to attach the swing arm to. Need 2.



A45475NUT	28-31	Price Ea.	\$ 1.45
-----------	-------	-----------	---------

Closed Cab Pickup Pivot Bolt & Nut

This kit has the hardware to hold the swing arm to the windshield frame on both sides.



A45475S	28-29	Price Set	\$ 2.70
---------	-------	-----------	---------

The '30-'31's Windshields did not use sleeve nuts. The A45475NUT was used for nuts.



A45476B	30-31	Price Set	\$ 0.75
---------	-------	-----------	---------

Closed Cab Pickup Swing Arm Washers

You need one set of these for your cab. These are chrome cup-shaped washers with rubber inserts that go on the swing arms.



A45477S	28-31	Price Pair	\$ 2.50
---------	-------	------------	---------

Closed Cab Pickup Swing Arm Nuts

These are the chrome-plated nuts that hold the swing arms in place when you open the windshield.

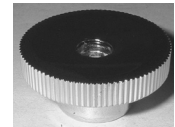

A45482	28-31	Price Pair	\$ 6.95
--------	-------	------------	---------

Installation of Swing Arms

A45475S - 28-29
A45476B - 30-31

A45477S on both side
of Swing Arms

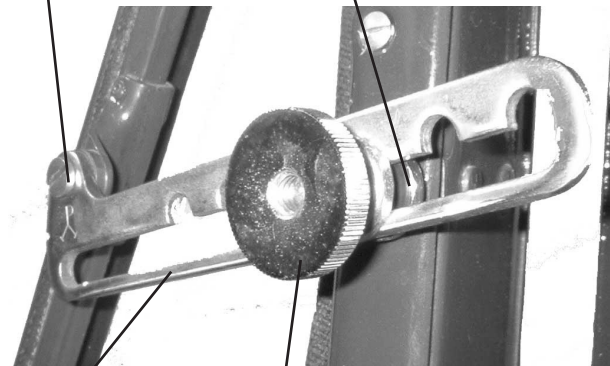

A45463N
or
A45463S

A45482

WINDSHIELD WIPERS

From Oct. '27 thru July '30 Hand Operated Wipers were used for the Roadster Pickup and Closed Cab Pickup. Starting in July 1930 thru end 1931 Vacuum wipers were introduced. An aftermarket Electric Wiper is available for those who cannot obtain a suitable core for an original electric wiper.

Hand Wiper

This is the chrome plated hand wiper that was used on all '28 Open Cab and Commercials until June '30.

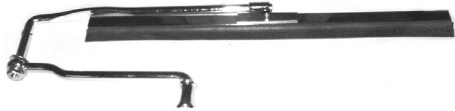

A17655AR 28-30 Price Ea. \$ 21.00

Electric Wiper Motor

This is a universal 6-volt motor that mounts on the inside of the car. The shaft is sleeved and threaded to hold it in place. **Does not include wiper blade and arm.** 110 Degree Sweep.

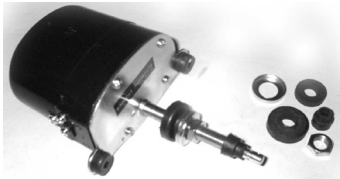

Black Housing - With On - Off Switch. - 1928-1931. The 6 Volt shaft can be adapted from the 3 1/4" to 2 1/2" if necessary. Unless you adapt the motor to go thru the windshield frame with an angled hole, you will not be able to open the windshield. For arms and blade for this motor, we suggest A17529A (Page P/UP 33) or A17529CHP Arms and A17528 (Page P/UP 33) or A17528B Blades.

A17508E6 6 Volt - 3 1/4" Shaft Price Ea. \$ 41.25

A17508E12 12 Volt - 3 1/4" Shaft Price Ea. \$ 52.75

Electric Wiper Assembly

This is a polished stainless steel assembly **complete with arm and blade. Really nice.** Instructions are included for shortening shaft if required.



A17508SS6 28-31 6 Volt - 5" Shaft - No On-Off Switch Price Ea. \$ 55.00

A17508SS12 28-31 12 Volt - 5" shaft - No On-Off Switch Price Ea. \$ 49.95

Electric Wiper Wire Kit

Replace your dirty, cracked wiper wire with this correct black and blue cloth-covered wire. It runs from the terminal box to the wiper motor and has the flag connector for the terminal box end.



A17500WK 28-31 Price Ea. \$ 3.75

Electric Wiper Wire Clip - Roadster Pickup

This clip holds the electric wire on the windshield frame for the Roadster Pickup only.



A17659 28-30 Price Ea. \$ 2.75

Electric Wiper Wire Clip

You will need three of these to hold the wiper motor wire to the header on Closed Cabs.



A17616A 28-30 Price Ea. \$ 1.50

Closed Cab Electric Wiper Wire Supports

You will need three of these to hold the wire which goes to the wiper motor plus to support the cowl light wire. Need 3 per Car.

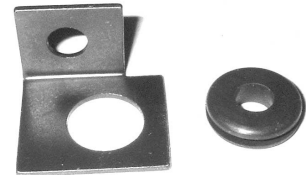

A14593A 28-29 Price Ea. \$ 2.25

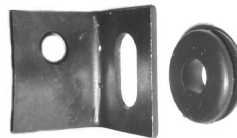

A14593 30-31 Price Ea. \$ 2.90

***** MIKES TIPS *****

Use only Replacement Blades with Replacement Arms and Show Blades with Show Arms.

Replacement Electric Wiper Arm - Closed Cab Pickup

If your wiper motor is mounted on the outside of the cab, this is the arm to use.



A17529A 28-31 Price Ea. \$ 3.75

PICKUP

Mike's "A" FORD-ABLE Parts

Replacement Electric Wiper Arm (Generic)

If you've got the aftermarket A17500-E6 motor, you will need this wiper arm. You can use the A17528 or A17528B blade. This is a chopped (shorter) Arm also for Street rods.



A17529CHP 28-31 Price Ea. \$ 10.95

Replacement Electric Wiper Blade

These wiper blades fit all Model A Replacement arms.

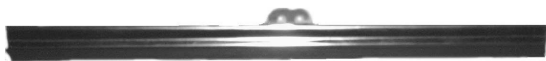

A17528 28-29 7-1/4" Blade
Price Ea. \$ 2.50

A17528B 30-31 8-1/4" Blade
Price Ea. \$ 2.75

Electric Wiper & Dome Light Wire Support

This clip was held in place by a bolt that held the gas tank to the cowl. It served as a grommet holder for the wiper and or dome lamp wire, and the other part of the clip held the top of the kick panel in place. Grommet included. 2 Required.

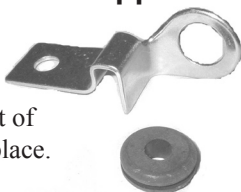

A14591 28-29 Price Ea. \$ 4.30
A14591GR Grommet Only Price Ea. \$ 0.70

Manifold Hole Plug

This is the special slotted pipe plug which was used on the side of the block near the oil pump to let you see if your oil pump was working. This is also used for the valve fitting on the inlet manifold to plug the hole. To hold in the oil pump while changing the pan gaskets - use A6701 Page Gen. 118. This is also used to plug the intake manifold when an electric wiper is used.



A6621 28-31 Price Ea. \$ 0.65

Electric and Vacuum Tandem Wiper Kit

This kit allows you to add on a wiper for the passenger side so they can see, too! It will adapt to A17508 6V or 12 V Motor. Before drilling any holes, make sure the distance between the Motor Shaft and the Pivot Shaft is EQUAL to the length of the Link Rod Assembled to the Wiper Arm.

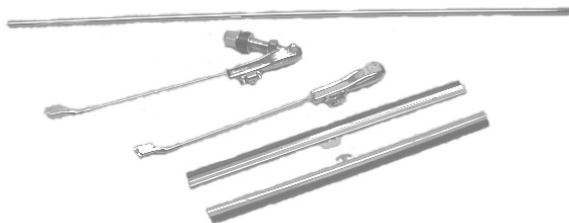

A17574 28-31 Price Set \$ 29.15

There are not any decent New Vacuum Wiper Motors available. We can rebuild a good core.

Vacuum Wiper Motor Control

Here's the on/off control for the outside mounted wiper motor. This passes through the windshield frame.



A17534 28-31 Price Ea. \$ 3.95

Vacuum Wiper Mounting Screws

Made in the USA. Here are the screws needed to mount the vacuum wiper motor.



A17500CMB 30-31 Closed car
Price Pair. \$ 1.10



A17500OMB 30-31 Open car
Price Pair. \$ 1.10



Show Vacuum Arm

8 1/4" Chrome, Clip Type Arm used from October 1930 thru 1931.



A17565E 30-31 Price Ea. \$ 16.00

Show Quality Vacuum Wiper Blade

8 1/4" Chrome blade with single arm rivet clip, five ply rubber. July 30 - End 31 - Deluxe open cabs with Vacuum Wipers.



A17506G 29-31 Price Ea. \$ 16.50

Trico Vacuum Wiper Bowl Gaskets

If you need only the bowl gaskets for your Trico motor, Mike's got them.



A17508G 29-31 Price Pair \$ 2.35

Mike's "A" FORD-ABLE Parts

Trico Vacuum Wiper Motor Tag

If your Trico embossed tag has been painted or marred, replace it with this new one.



A17508T

Price Ea. \$ 3.50

Chrome Vacuum Wiper Knob

Replace your worn knob with this new one.



A17513

28-31

Price Ea. \$ 1.75

Trico Vacuum Wiper Knob

If you want the knob with "TRICO" on it, this chrome-plated knob is for you.



A17513D

29-31

Price Ea. \$ 3.50

Roadster Pickup Vacuum Stanchion Line

This is the chrome vacuum line for Roadster Pickups. It mounts on the left side windshield stanchion. Mounting clips included.



A17517S

30-32

Standard

Price Ea. \$ 8.85

A17517D

30-32

Deluxe

Price Ea. \$ 7.50

Roadster Pickups use a rubber hose 13 1/2" long from the wiper motor to the stanchion tube, and 20 1/2" from the bottom of the stanchion tube, behind the kick panel to the steel vacuum line.

Vacuum Wiper Hose

Six feet of the small diameter hose for the wiper. Rubber. Used on all cabs with wipers.



A17520

28-31

6 Ft.

Price Ea. \$ 2.25

Fabric Vacuum Wiper Hose

For the show car, Mike has this simulated fabric covered wiper hose. Used on all cabs with wipers.



A17520OR

30-31

Price Ea. \$ 6.00

Vacuum Wiper Hose Clip - Roadster Pickup

This clip goes on the windshield of the Roadster Pickup to hold the wiper hose.



A17669

28-31

Price Set \$ 1.45

Vacuum Wiper Hose Header Clips - Closed Cab Pickup

This set of three clips hold the wiper hose in place under the windshield hinge on the closed car. The hinge screws also secure these clips. Sold as a set of three.



A17616

30-31

Price Set/3 \$ 2.95

Manifold Vacuum Line Connector

This is the brass connector that screws into the intake manifold that you connect the vacuum line to.



Manifold Hole size - 1/8 - 27 Pipe Thread.

A17540

29-31

Price Ea. \$ 1.10

Manifold Vacuum Line

Mike has the steel vacuum line with brass fittings included. This goes from the intake manifold up to the firewall.



A17543A

28-31

Price Ea. \$ 3.45

Manifold Vacuum Line Fittings

These are new quality vacuum line fittings. There are included with a new Manifold Vacuum Line A17543A or A17522.



A17543F

28-31

Price Ea. \$ 0.45

Firewall Vacuum Line Connector

This is the double female brass connector that attaches to the firewall for both inside and outside vacuum lines to connect.



Includes 1/2-20 Cad. Nut.

A17541

29-31

Price Ea. \$ 3.25

Inside Vacuum Line (Brass Fittings Included)

This is the steel vacuum line that goes from the firewall under the gas tank and up the stanchion on Closed Cabs. This can also be used on Open Cars from the firewall fitting across the firewall to the cowl panel.



A17522

29-31 36" long

Price Ea. \$ 4.10

Mike's "A" FORD-ABLE Parts

Wiper Clamps (Open Cabs)

These are the chrome clamps which hold the wiper motor to the windshield frame.



A17589SS

28-31

Price Pair \$ 5.10

Grandfathers Day - Always 1st Saturday of June Every Year.

All Model A's are welcome.



AA Stake Bed Pickup

Give us a call - 1-888-TRY-MIKE (879-6453) **Have an "A" Day! P/UP-35**

ROADSTER PICKUP TOPS

Roadster Pickup Top Irons

Mike has the complete set of top irons which include, the hold down clamps, thumb screws, prop nuts, the wooden cross bows, top irons and rivets - ready to install. For Wooden Cross Bows see **Page P/UP 13**.



A43501D	28-29	Roadster Pickup	Price Set	\$ 510.00
A43501E	30-31	Roadster Pickup	Price Set	\$ 510.00

Universal Top Iron Kit

This top iron assembly is manufactured to fit all Ford Roadsters from 1928 thru 1932, and will probably fit other makes of Roadsters as well. The kit is also designed to fit Ford Roadster Pickups from 1928 - 1934. Extra holes have been drilled to allow for the differences in body and windshield dimensions, and to allow for stock or chopped windshields. The header board comes pre-cut and formed, to be drilled on the Top Irons have been mounted to the windshield. The top bows are made in three sections, comprising of two rounded ends and a straight center piece, which is supplied longer than necessary, to be cut to length on the top irons to be fitted to the vehicle. This section then slides over two sleeves that protrude from the rounded ends, to complete the formation of the top bows. The kit is manufactured of steel, the header board is of premium hardwood, has stainless steel fasteners and is supplied with fitting instructions. The top can be lifted off in one piece, or folded down like original. Once mounted, the top irons are ready to go to the upholstery shop of your choice.



A43501MU	28-32	Price Set	\$ 490.00
-----------------	--------------	------------------	------------------

Roadster Pickup Curtain Rods

The authentic curtain rods are exactly like the originals in every detail.



A180623	28-31	Std Round - Roadster Pickup	Price Pair	\$ 26.95
----------------	--------------	------------------------------------	-------------------	-----------------



A41970B	28-29	Authentic - Roadster Pickup	Price Pair	\$ 38.00
A41970C	30-31	Authentic - Roadster Pickup	Price Pair	\$ 39.00

Roadster Pickup Top Straps - Fold Down Tops.

Designed for use with Lebaron Bonney folding top assemblies. Stainless Steel mounts, leather straps and mounting hardware included.



Available in Complete Sets Only
Only for Fold Down Tops.

PU352	28-29	Price Set	\$ 47.50
PU353	30-31	Price Set	\$ 47.50

Roadster Pickup Lift the Dot Socket Tool

This is the Tool to install the UF16 - Lift the Dot Sockets with prongs. Punches a hole and 4 slits in the perfect location for mount the Sockets.



UF16T	09-31	Price Ea.	\$ 49.95
--------------	--------------	------------------	-----------------

For More Side Curtain Fasteners, Body Sockets & Tools, etc. see Page Gen. 233 & 234 in the Upholstery Section for a complete list.

PICKUP

CLOSED CAB PICKUP TOPS

Closed Cab Pickup Top Kits

These kits are complete with the top decking, foam padding, and everything else you'll need excluding chicken wire. Instructions Included.

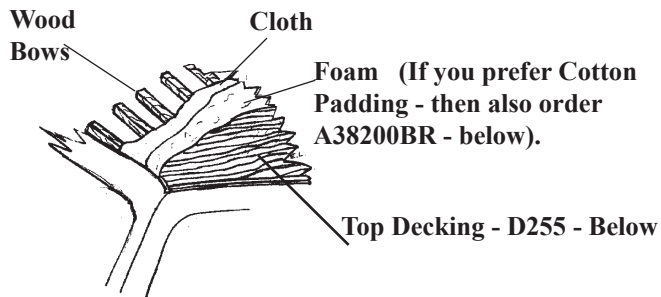

ATRK/C15B31 28-31 Closed Cab Pickup
Price Ea. \$ 79.95

Closed Cab Pickup Top Decking - Cobra Long Grain

Tops do wear out so Mike has this long-grain cobra top decking. It's 64" wide; Sold by the foot.

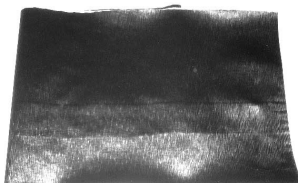

D255 28-31 Top Decking 64" wide
Price/Ft. \$ 6.95

Closed Cap Pickup Cotton Padding

This is the cotton padding that goes under the top decking. 40" wide x 4ft.



A38200BR 28-31 CC Pickup 4 Foot
Price Ea. \$ 8.50

Closed Cab Pickup Curved Roof Panels - Front

This panel goes above the door to the rib rail. You will have to drill holes to mount the panel and rain gutters.

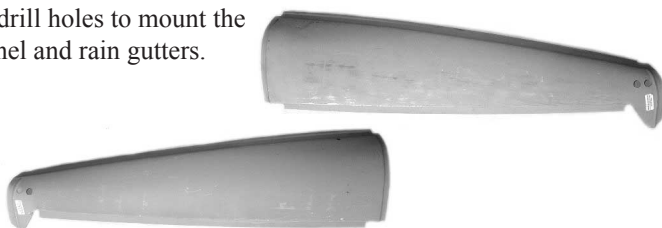

A47776PL 30-31 Pickup Left
Price Ea. \$ 130.00
A47776PR 30-31 Pickup Right
Price Ea. \$ 130.00

Closed Cap Pickup Rain Gutters - 1/2 Sets

One set (45") will do both sides with this aluminum gutter that you bend to the contours of your cab. Fasten the flat piece to the roof and the gutter piece snaps into it.

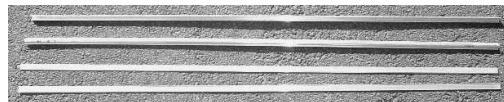

A47301A Pickups - 1/2 Sets
Price 1/2 Set \$ 12.00

Closed Cab Pick-Up Rain Gutters - Original Style

For the show-truck, this is an exact reproduction of the rain gutter used on the original '28-'29 Closed Cab Pickups. 30 3/4" Long.



A47301AOR 28-29 Price Pair \$ 36.50

Closed Cab Pick-Up Rain Gutters - Original Style

For the show-truck, this is an exact reproduction of the rain gutter used on the original '30-'31 Closed Cab Pick-Ups. 31 1/2" Long.

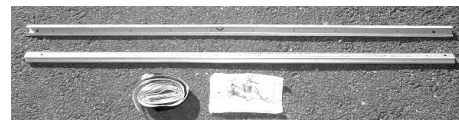

A47301BOR 30-31 Price Pair \$ 35.50

Closed Cab Pickup Welting (Wire Welt) - Crown Vinyl Molding

This half round welt (wire welt) is often used in place of the metal roof molding. You nail it down and fold it over to form a nice fabric bead. Measure carefully as scraps cannot be returned. Comes per foot.



A47304 28-31 Price/Ft. \$ 0.90

Closed Cab Pickup Split Welting (Hid'em)

This split welting was used on the following trucks: the '28-'29 closed cab; Panel Delivery; and the '31 Special Delivery. This can be used with most models with a wood top.



A47305 28-31 Black Price/Ft. \$ 0.65
A47305T 28-31 Tan Price/Ft. \$ 0.80

Mike's "A" FORD-ABLE Parts

Closed Cab Pickup Top Roof Molding - Style # 2

This style of aluminum molding goes on the front over the sun visor for the '30-'31 Closed Cab Pickup 82 B & '30-'31 Deluxe Del 130 B



A473012 5 Ft. Piece 1/2" wide
Price Ea. \$ 12.60

Closed Cab Pickup Top Roof Rear Molding - Style # 8

Used on the rear of '30-'31 CC Pickups 82B & '30-'31 Del. Delivery.



A473018 28-31 6 feet long - need 2 pieces
Price Set/2 \$ 18.45

Hid'em Welt End Tip

This nickel-finished tip (with nail) is used to complete the trim when using the hide'em welting.



A47303A 28-31 Price Ea. \$ 1.25

Roof Tacks

This is a set of 100 plated tacks used to tack the black vinyl decking to the wood top frame. The top molding covers these tacks.



A38425MBR 28-31 Price Pack \$ 2.25

Body Nails

Commonly used on all Model "A's".

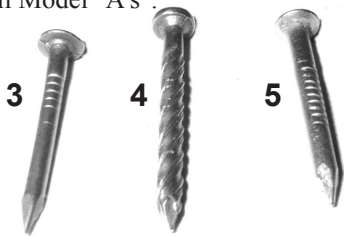

Nail Style #3
.074 diam. x 3/4" long - oval head - pack of 100
Price Pack \$ 1.50

Nail Style #4
Top Mouldings & Rain Gutters
.085 x 7/8" long - pack of 100
Price Pack \$ 1.50

Nail Style #5
Use these where rusting could occur - Stainless Steel
.085 x 3/4" long - pack of 100
Price Pack \$ 3.00



Aerial Views of our First Grandfathers Day - June 2004.



PICKUP

ROADSTER PICKUP DOOR HANDLES AND PARTS

Roadster Pickup Door Edge Protector

Great idea to protect your door paint. Clips into studs that are usually used for side curtains. Available in Tan Canvas. Includes fasteners to be installed by customer. Soft napped backing



A35000 28-31 Price Pair \$ 45.00

Roadster Pickup Door Check Straps

These are nice light brown leather straps complete with chrome plates and mounting screws.

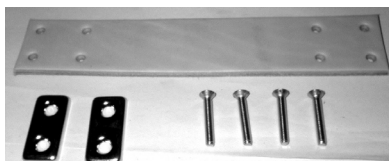

A702828S 28-31 Price Pair \$ 21.95

Roadster Pickup Door Hinge Sets

Sets of hinges for the open cab doors. Each set has both upper and lower hinges for both sides of the cab - Hinge Pin is included.

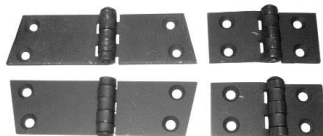

In Aug. '30 till end, the bottom door hinge was changed from two mounting holes to three holes on the Cowl Post (lower) Hinge Only.

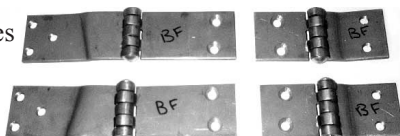

Front Door - Two Hole Hinge

A35600AF 28- July 30 Roadster Pickup Price Set/4 \$ 59.00

Front Door - Three Hole Hinge

A35600BF Aug 30-31 Roadster Pickup Price Set/4 \$ 59.95

Roadster Pickup Hinge Pins

Mike has these authentic hinge pins.



A35615 28-31 Price Set 4 \$ 2.00

Hinge Pin Remover

This helpful tool, uses three graduating hardened push pins to push your old hinge pins up and out of the hinge. As you tighten the bolt it will push the dowel and the old pin out. Set comes complete with 3 different length push pins and complete instructions.

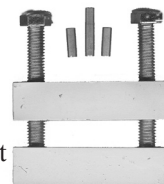

This item is NOT Refundable!!

T46335HR 28-31 Price Ea. \$ 28.75

WARNING!!!

If your dowel pins start bending DO NOT go any further with this tool. These dowels are made from a hardened steel but NOT case hardened. The manufacturer has issued a warning that if a case hardened or heat treated steel was used, it could very well explode or splinter under such pressure, and possibly do bodily harm. I suggest trying penetrating oil, but if that doesn't work, then take a fine drill bit and try drilling at least halfway through the pin. Then use the removing tool.

Roadster Pickup Hinge Bolts

These are the hardware sets to attach the open car hinges. Each set contains 4 nuts, bolts, and washers. The DMB attaches door to hinge; the PMB attaches hinge to post. One Set does 1 Door.



A35600DMB 28-31 Price Set/16 \$ 2.85



A35600PMB 28-31 Price Set/12 \$ 2.00

Roadster Pickup Door Hinge To Door Screws

This set of nine screws is needed to attach the door hinge to the door. 9 x 5/16-24 x 1/2". Will not work on '28-'29 Closed Cab Pickups - some bodies require cup washers. One set does one door.



#109 30-31 Price Set/9 \$ 2.45

Roadster Pickup Door Hinge To Body Post Screws

This set of three screws is needed to attach the door hinge to the body. 6 Piece Set. 3 Screws and 3 Washers.



#109B 30-31 Price Set/6 \$ 1.75

Mike's "A" FORD-ABLE Parts

Roadster Pickup Door Hinge Washers Only

A special countersunk washer used when mounting the floorboards. These washers are also used on some of the door hinges.



See Page Gen. 93 for more floorboard items.

#109W 28-31 Price Ea. \$ 0.12

Roadster Pickup Bottom Door Seal

This is an 8 foot section of rubber to seal the bottom of the door. Please use A19009 if you have reproduction doors



A19010 28-31 Price Ea. \$ 6.95

Roadster Pickup Bottom Door Seal (Reproduction doors)

This rubber seal goes on the bottom of the door and is held in place by the same clips that hold the door panel on.



1 Roll is enough for all Cars.

A19009 28-31 Price Roll \$ 6.25

Roadster Pickup Interior Trim Screws

These sets of screws are exactly what is needed for your Roadster Pickup.

#1007 28-29 Roadster pickup Price Set \$ 6.00

#1008 30-31 Roadster pickup Price Set \$ 7.95

Robertson Interior Trim Screw Kits

For all Canadian built cars.

CR2 1928AR Roadster Pickup Price Set \$ 6.80

CR14 30-31 Roadster Pickup Price Set \$ 9.40



Roadster Pickup Stainless Door Handles

For the purist, these are very good stainless steel outside door handles.



A7023500 Oct. 28 - 31 Price Ea. \$ 28.05

Roadster Pickup Door Handle Screws

This is a set of four Stainless machine screws to attach the door handle.

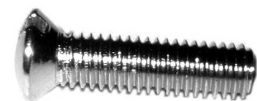

4 x 10-32 x 11/16 Oval Head Screws.

A702780MB 28-31 Price Set/4 \$ 1.25

Pickup Door Handle Pads

These flat rubber pads go between your outside handle and the cab to prevent scratches and rattles.



A702356A 28-31 Roadster Pickups Price Pair \$ 1.00

Roadster Pickup Inside Door Knob

This chrome-plated door knob is for the '28 - mid '30 Closed Cab and Roadster Pickup.



A17261B 28-30 Price Ea. \$ 4.75

1928 Roadster Pickup Door Latch

This is the latch used on the '28 Roadster Pickup with no outside handle. For knob see A17261B above. Paint Latch Body Color.



A35655AL 1928 Left Price Ea. \$ 19.00
A35655AR 1928 Right Price Ea. \$ 19.00

Roadster Pickup Upholstery Trim

One set of these metal trim pieces does both doors on the '28 models. Trim goes around the striker, the door opener, and the dovetail. Instructions Included.



TA45320 1928 Price Set/6 \$ 11.25

Roadster Pickup Inside Door Opener

Chrome plated inside door handle.

Used on:

June 30-31 Roadster Pickups,
1929 - 31 Station Wagons.

Includes one 10-32 x 1/2" Oval Head Stainless Screw.



A702400C 30-31 Price Ea. \$ 8.50

Roadster Pickup Door Handle Escutcheon Washer

Original size, Brass, Nickel Plated, with rubber anti-rattle washer.

June 1930 - 1931 Roadster Pickup
1929 - 1931 Station Wagons.



A47508 30-31 Price Set \$ 2.60

PICKUP

P/UP-40 Give us a call - 1-888-TRY-MIKE (879-6453) Have an "A" Day!

Mike's "A" FORD-ABLE Parts

Roadster Pickup Door Latch

This style latch fits any of the '28-'31 Roadsters Pickups that do have outside handles. Paint Latch Body Color.



A35655ABL	Oct '28 - 31 Left	Price Ea.	\$ 22.00
A35655ABR	Oct '28 - 31 Right	Price Ea.	\$ 22.00

Roadster Pickup Latch Screws

Only one set of these special flat-headed countersunk screws is needed to attach the latches to both doors.

Eight 10-32 x 1/2" Flat Headed Screws. Paint Body Color.



A35655MB	28-31	Price Set/8	\$ 0.95
----------	-------	-------------	---------

Roadster Pickup Dovetail

This two-hole male dovetail was used on the 1930-1931 Trucks.

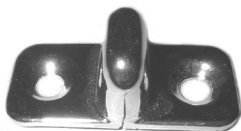

A76819A	30-31	Price Ea.	\$ 3.75
---------	-------	-----------	---------

Roadster Pickup Dovetail Screws

These machine screws hold the male dovetails in the door jams for 1930-1931 Trucks.



A76819MB	30-31	Price Set/4	\$ 1.25
----------	-------	-------------	---------

Dovetail Backing Plate

This plate was used on the 1928 - Early 1930 Roadster Pickup.



RAR257	28-30	Price	\$ 6.25
--------	-------	-------	---------

Roadster Pickup Door Bumpers

Mike has complete sets of the rubber, metal, and clips needed to change out the door bumpers for the following models.

The rubber may need trimming.

These are the best quality available.



1928-1929 Roadster Pickup 16 piece set.			
A702610ES	28-29	Price Set	\$ 8.95

1930-1931 Roadster Pickup 16 piece set.			
A702610FS	30-31	Price Set	\$ 9.25

Roadster Pickup Door Bumper Dovetail Clip

This is the brass clip for the female dovetail on all Roadster Pick-Ups.

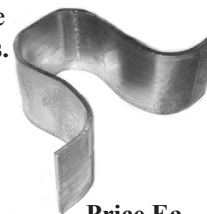

A702610C	28-31	Price Ea.	\$ 1.75
----------	-------	-----------	---------

Roadster Pickup Striker Plate

This striker plate goes on the door post and fits all the open cabs. Located on the door post.



A37505	28-31	Price Ea.	\$ 6.00
--------	-------	-----------	---------

Roadster Pickup Striker Mount Set

One set will be enough to attach the striker plate on both sides.



A37505MB	28-31	Price Set/4	\$ 1.50
----------	-------	-------------	---------

Roadster Pickup Upholstery Channels

These channels go on the rear quarter panels to hold the upholstery panel on the '28-'29 Roadster Pickup.



A1052	28-29	Price Pair	\$ 40.00
-------	-------	------------	----------

Upholstery Clip

These clips are made to hold the upholstery to the door on the Pick-Ups.



A46126	28-31	Price Set/10	\$ 2.50
--------	-------	--------------	---------

Pickup Door Panel Nail

Pebble finished large headed nail to hold the door panel in place, with plastic holder.



A32180		Price Each	\$ 0.70
--------	--	------------	---------

CLOSED CAB PICKUP DOOR HANDLE AND PARTS

Closed Cab Check Straps

This double loop door check strap is 6" long and was used on



'29-'31 Station Wagon rear doors and 1928-1930 Closed Cab Truck all with side mount spare tires.

A162592-6 Price Ea. \$ 3.65

This double loop door check strap is 7" long and was used on '28-'30 Closed Cab Truck and Panel Delivery rear doors.

A162592-7 Price Ea. \$ 3.65

Closed Cab Check Strap Bracket

Used with the rubber door check straps. Used on '28-'29



Closed Cabs, and on the rear doors of Station Wagons.

A162592L Price Ea. \$ 1.15

Closed Cab Pickup Door Check Strap Bracket Screws

1928 - 29 Closed Cabs Only. This is the set of screws needed to attach your door check strap. 12/24 x 3/4" Oval Head Machine Screw.



#48 Price Set/8 \$ 1.50

Closed Cab Pickup Door Check Post Bumper

This pair will do both doors. The square rubber mounts in the door post for the door check bumper to butt against.

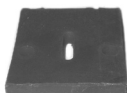

A702828BU Price Pair \$ 3.95

Closed Cab pickup Door Check Arm Brackets

Top and bottom brackets are spot welded to the door post to receive the arm (A702828CL). Order 1 set per door.

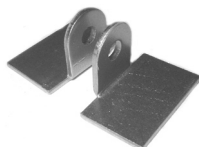

A702828BRKT Price Set/2 \$ 4.90

Closed Cab Pickup Door Check Arm And Rubber Bumper

This steel arm door check was used on all the Model A's that didn't have the rubber strap style footman's loop.



A702828CL Price Pair \$ 6.15

Closed Cab Pickup Door Check Bumper

This style of rubber bumper was used with the steel arm door checks. It attached inside the door.



A702828R Price Pair \$ 2.05

Hinge Pin Remover

This helpful tool, uses three graduating hardened push pins to push your old hinge pins up and out of the hinge. As you tighten the bolt it will push the dowel and the old pin out. Set comes complete with 3 different length push pins and complete instructions.

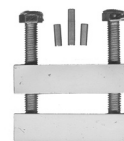

This item is NOT Refundable!!

T46335HR Price Ea. \$ 28.75

WARNING!!!

If your dowel pins start bending DO NOT go any further with this tool. These dowels are made from a hardened steel but NOT case hardened. The manufacturer has issued a warning that if a case hardened or heat treated steel was used, it could very well explode or splinter under such pressure, and possibly do bodily harm. I suggest trying penetrating oil, but if that doesn't work, then take a fine drill bit and try drilling at least halfway through the pin. Then use the removing tool.

Closed Cab Pickup Door Hinge

A cast bronze hinge for the '28-'29 Closed Cab Pickup. Hinge pin hole is drilled and pin is installed. You will have to drill / tap mounting holes and cut to length. Will work on top, middle or bottom.



A46300TS Price Ea. \$ 69.00

PICKUP

Mike's "A" FORD-ABLE Parts

Closed Cab Pickup Door Hinges

The hinge pin holes are drilled, but the body mounting holes are **NOT** drilled. Unfinished Cast Bronze.
Used on '30-'31 Pickup.

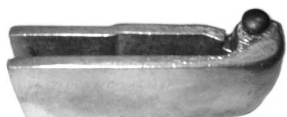

A46300L	30-31	Lower Hinge	Price Ea.	\$ 78.00
A46300M	30-31	Middle Hinge	Price Ea.	\$ 78.00
A46300U	30-31	Upper Hinge	Price Ea.	\$ 78.00

Closed Cab Pickup Door Hinge Pins

These round headed hinge pins are authentic for the Closed Car Only.



A46335	28-31	Standard - .233 / .236	Price Ea.	\$ 0.45
A46335OS	28-31	Oversized - .247 / .250	Price Ea.	\$ 0.45

Closed Cab Pickup Stainless Door Hinge Pin

This stainless steel hinge pin is knurled with a polished head. They fit the Coupes, Tudors and Pick-Ups.



A46335SS	28-31	Price Ea.	\$ 2.55
----------	-------	-----------	---------

Closed Cab Pickup Hinge Screws

These are the hinge screws sets you will need for your Closed Cab.

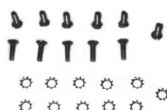

1928-1929 Closed Cab Pickup			
One set does one door.			
A80302DMB	Hinge to Door	Price Set/22	\$ 2.00
A80302PMB	Hinge to Post	Price Set/18	\$ 2.00

Closed Cab Pickup Door Hinge To Door Screws

This set of nine screws is needed to attach the door hinge to the door. 9 x 5/16-24 x 1/2". Will not work on '28-'29 Closed Cab Pickups - some bodies require cup washers. One set does one door.



#109	30-31 Only	Price Set/9	\$ 2.45
------	------------	-------------	---------

Closed Cab Pickup Door Hinge To Body Post Screws

This set of three screws is needed to attach the door hinge to the body. 6 Piece Set. 3 Screws and 3 Washers.



#109B	30-31	Price Set/6	\$ 1.75
-------	-------	-------------	---------

Washers Only

A special countersunk washer used when mounting the floorboards. These washers are also used on some of the door hinges.



For more floorboard items see the "Floorboard" Category in the General Section - See Page Gen. 93.

#109W	28-31	Price Ea.	\$ 0.12
-------	-------	-----------	---------

Closed Cab Pickup Bottom Door Seal

This rubber seal goes on the bottom of the door and is held in place by the same clips that hold the door panel on. 1 Roll is enough for all Cabs.



A19009	28-31	Price Roll	\$ 6.25
--------	-------	------------	---------

Closed Cab Pickup Interior Trim Screws

These sets of screws are exactly what is needed.

#1009	28-29	Closed cab pickup	Price Set	\$ 12.00
#1010	30-31	Closed cab pickup	Price Set	\$ 12.00

Robertson Interior Trim Screw Kits

For all Canadian built cars.

CR7	28-29 Closed Cab Pickup	Price Set	\$ 15.10
-----	-------------------------	-----------	----------



Closed Cab Pickup Door Handle Screws

This is a set of four Stainless machine screws to attach the door handle.

4 x 10-32 x 11/16 Oval Head Screws.



A702780MB	28-31	Price Set/4	\$ 1.25
-----------	-------	-------------	---------

*****Mike's Tips *****

The Model A outside handles have a square shaft with a section machined square with opposite corners near the end. The handle must be pulled out, then rotated 45 degrees so the corners line up, then pulled and back again. Kind of pull-twist-pull-twist-pull. Reverse applies to installation. It was an early theft prevention idea since the passenger side locking handles just lock themselves rather than the latch assembly. The driver's side doors lock from within.

Mike's "A" FORD-ABLE Parts

Locking Outside Door Handles

This chrome-plated locking handle was originally used only on the right hand door but can be used on the left as well. Used on **Closed Cab Pickups**.



A702350AL 28-29 Price Ea. \$ 34.00

A702350BL 30-31 Price Ea. \$ 34.00

Closed Cab Pickup Outside Door Handles

This chrome-plated handle was used only on the left hand door but it can be used on the right as well. For the 1930-1931 Truck.



A702351B 30-31 Price Ea. \$ 24.95

Closed Cab Pickup Outside Door Handle

This is a very good reproduction with the black insert on a chrome-plated handle. Also fits 1926-1927 "T" Closed Cab. Use A702828MB Screws.



A702350P 28-29 Price Ea. \$ 24.95

Closed Cab Pickup Door Handle Pads

These flat rubber pads go between your outside handle and the cab to prevent scratches and rattles.



A702356A 28-29 Price Pair \$ 1.00

A702356D 30-31 Price Pair \$ 1.00

Closed Cab Pickup Door Handle Cup And Spring

You'll need one set per handle of this special cup washer and spring. The spring is crimped onto the outside door handles under the escutcheon. Not needed when purchasing new handles. Works best on original handles. 2 Piece Set - contains 1 spring & 1 cup.



A702350R 28-31 Price Set/2 \$ 1.55

Closed Cab Pickup Inside Door Knob

This chrome-plated door knob is for the '28 - mid '30 Closed Cab Pickup.



A17261B 28-30 Price Ea. \$ 4.75

Closed Cab Pickup Door Lever Anti-Rattler

This style was used on some of the Model A trucks with the slide door opener. This is a carry over from Model "T".



A8320B 28-29 Price Pair \$ 3.95

Closed Cab Pickup Steel Garnish Molding

These steel reproduction garnishes are really good quality.



A842A 28-29 Closed Cab Pickup - 27 3/8" Price Pair \$ 80.00

A442B 30-31 Closed Cab Pickup - 27 7/16" Price Pair \$ 80.00

Closed Cab Pickup Garnish Molding Screws

These screws are 10/32 x 1/2 to attach the garnish molding to the door.



A342S 28-31 Price Ea. \$ 0.15

Closed Cab Pickup Sliding Door Lock

This is the inside door lock that goes on the left hand door of the '30-'31 Pickups.



A46168 30-31 Price Ea. \$ 4.95

Closed Cab Pickup Sliding Door Lock Screws

This is a set of the small flat-head machine screws you'll need to attach the A46168 slide lock. 2 x 10/32 x 1/2"



A46168MB 28-31 Price Pair \$ 0.95

Closed Cab Pickup Deluxe Slide Lock Escutcheon

This is the escutcheon for the slide style inside lock on the left-hand door.



Includes a large washer.

After March 1930 - Closed Cab Pickup

A46272 28-31 Price Ea. \$ 3.45

PICKUP

Mike's "A" FORD-ABLE Parts

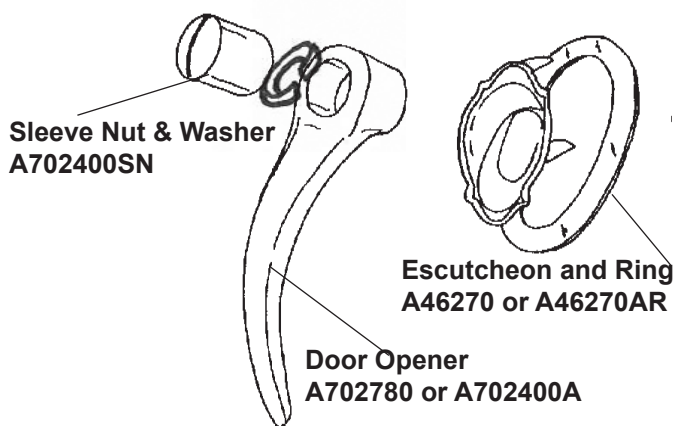

Closed Cab Pickup Inside Door Handles - Plain (Lift up Style)

This authentic reproduction was used on:
'30-'31 Closed Cab Trucks.



Order A46270AR Escutcheon - below.
Order A702400SN Sleeve Nuts - below.

A702780AOR	30-31	Chrome	Price Ea.	\$ 6.95
A702780NOR	30-31	Nickel	Price Ea.	\$ 6.95

Closed Cab Pickup Standard Inside Door Handle Escutcheon

This standard escutcheon for the inside door handles A702780AOR or NOR is made just like the original.



Includes Washer.

A46270AR	28-31	Price Ea.	\$ 6.75
----------	-------	-----------	---------

Closed Cab Pickup Door Handle Sleeve Nuts

These threaded sleeve nuts were used to hold the lift up style door handles on the shaft. 1 x 5/16 - 24 Nut & 1/w.



A702400SN	28-31	Price Ea.	\$ 1.45
-----------	-------	-----------	---------

Closed Cab Pickup Inside Door Handle (Lift up Style)

This chrome-plated lift-up style inside door handle was used on:
'30-'31 Pickup



Order A702400SN Sleeve Nut.
Order A46270 Escutcheon.

A702400A	28-31	Square Top	Price Ea.	\$ 8.45
----------	-------	------------	-----------	---------

Closed Cab Pickup Deluxe Inside Door Handle Escutcheon

This is a deluxe style inside door handle escutcheon.
Includes washer.

Used on:

March '30 - 31 Closed Cab Pickup



A46270

Price Ea. \$ 3.75

Closed Cab Pickup Door Latch

This excellent quality door latch fits the 1930-31 Trucks. The driver's side latch has the lock mechanism.



A46105AR	28-29	Passenger side	Price Ea.	\$ 22.50
A46106AL	28-29	Driver's side	Price Ea.	\$ 22.50
A46105BR	30-31	Passenger side	Price Ea.	\$ 22.50
A46106BL	30-31	Driver's side	Price Ea.	\$ 22.50

Closed Cab Pickup Latch Wood - Door Lock Cover

This is the latch wood that is mounted vertically about halfway up the door post. Originally this was made of hard rubber.



AWD1283-3	30-31	CC Pickups & late '31 Steel Top	Price Pair	\$ 15.40
-----------	-------	---------------------------------	------------	----------

Closed Cab Pickup Latch Screws

This set has enough screws to attach the door latches on both sides on the Pickups.



A46105MB	28-31	Price Set/8	\$ 1.10
----------	-------	-------------	---------

Closed Cab Pickup Latch Rivet

This special tubed rivet holds the flipper to the latch mechanism.
2 Required.



A46105RI	28-31	Price Ea.	\$ 0.55
----------	-------	-----------	---------

Mike's "A" FORD-ABLE Parts

Closed Cab Pickup Door Latch Spring Set

A spring set for the 1928 - mid 1930 Closed Cab Pickup.



A80055RK 28-30 Price Set \$ 14.85

Closed Cab Pickup Door Latch Spring Set

This set of springs has all the springs needed for both door latches for all 1930-1931 Pick-Ups.

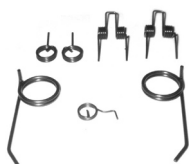

A46125 30-31 Price Set/7 \$ 6.60

Closed Cab Pickup Inside Door Latch Remote Rods

This is the rod that links the inside door handle to the door latch. Originals are almost always worn out or the threads are stripped. One kit does both doors. Kit includes the retainer plates, return spring and mounting screws.

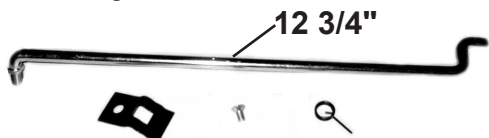

A702401A 30-31 Pickup Price Set/12 \$ 33.00

Closed Cab Pickup Inside Door Opener Control Rod Mounting Plates

These are the plates that hold the inside door handle remote rods in place. The set includes 4 plates and 4 mounting screws.



A702403S 30-31 Pickup Price Set/8 \$ 11.55

Closed Cab Pickup Dovetail

Mike has this chrome-plated 4-hole male dovetail for the Closed Cab Pickup.



A80330A 28-June 1930 Price Ea. \$ 2.95

Closed Cab Pickup Dovetail Screws

These screws were used on the 1928 - Early 1930 Pickups. 4 x 10/32 x 1/2" Oval Head Screws. Order 2 Sets for A80333.



A80330MB 28-30 Price Set \$ 0.75

Closed Cab Pickup Female Dovetail

This female dovetail for on Pickups already has the rubber attached.



A80333 28-June 1930 Price Ea. \$ 14.45

6- Hole Male Dovetail

Chrome plated. 30-31 Panel Delivery Order A61419MB for Screws.



A61419B 30-31 Price Ea. \$ 14.95

6 Hole Male Dovetail Screws

Nickel Plated Screws. Use these screws for A61419B. 6 x #8 x 1" Wood Screws.



A61419MB 28-31 Price Set/6 \$ 0.50

Closed Cab Pickup Dovetail

This two-hole male dovetail was used on the 1930-1931 Trucks.

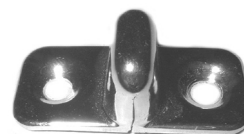

A76819A 30-31 Price Ea. \$ 3.75

Closed Cab Pickup Dovetail Screws

These machine screws hold the male dovetails in the door jams for 1930-1931 Trucks.



A76819MB 30-31 Price Set/4 \$ 1.25

Closed Cab Pickup Door Bumpers

Mike has complete sets of the rubber, metal, and clips needed to change out the door bumpers. The rubber may need trimming. These are the best quality available.



30-31 CC Pickup - 10 piece set.
A702610IS 28-31 Price Set \$ 8.95

Closed Cab Pickup - 12 piece set.
A702610NS 28-29 Price Set \$ 8.95

Closed Cab Pickup Door Bumper Clip

Spot Weld this three sided clip to the bottom of the door, 3 inches from the latch side, to hold the rubber door bumper in place. Uses one per door.



Mid 1930 - 1931 Closed Cab Pickup
A46457 28-31 Price Ea. \$ 4.25

PICKUP

Mike's "A" FORD-ABLE Parts

Closed Cab Pickup Striker Mount Set

One set will be enough to attach the striker plate on both sides.



A37505MB 28-31 Price Set/4 \$ 1.50

Closed Cab Pickup Striker Plate

This type of striker plate was used on 1930/31 Pick-Ups.



A46137 30-31 Price Ea. \$ 3.45

Closed Cab Pickup Striker Plate Mount Kit

There are enough screws here to attach the A46137 strikers on one door. 1/4-20 x 1/2 Round Head Screws.



A46137MB 30-31 Price Set/4 \$ 0.75

Closed Cab Pickup Bezel

This bezel clamps onto the door panel where the panel is notched for the striker. Pickups were painted black.



A48140 28-31 Price Pair \$ 2.50

Closed Cab Pickup Door Striker Plates

This two-piece set is painted black and ready to install on your '28-'29 Pickup. One set does one door.



A80085/87 28-29 Truck Price Set/6 \$ 13.70

Closed Cab Pickup Striker Shield

This shield attaches inside the striker to help hold the weather-stripping on the '28-'29 Closed Cab Pickup.

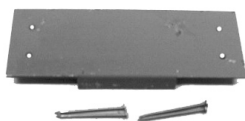

A80302 28-29 Price Set \$ 4.95

Closed Cab Pickup Door Plug

This plug fills the hole above the outside door handle on the Closed Cab Pickup.



A80303 28-29 Price Ea. \$ 5.20

Closed Cab Pickup Door Bumper Holder

This stamped steel holder is for the door bumper on the '28-'29 Closed Cab Pickup.



A80088 28-29 Price Ea. \$ 3.50

Standard Window Riser - A702780A

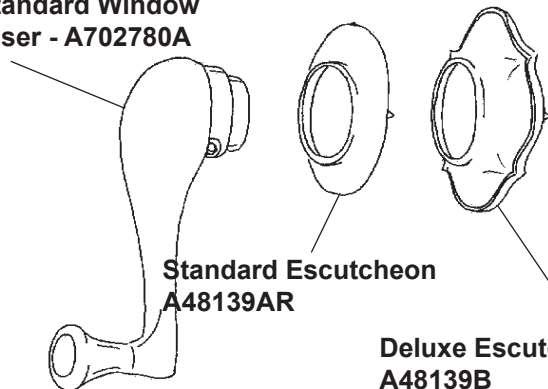

Standard Escutcheon A48139AR

Deluxe Escutcheon A48139B

Closed Cab Pickup Window Riser (Plain)

This is the standard chrome-plated window riser used on: 1928 - Mid '30 Closed Cab Pickups



Order A48139AR Escutcheon.

A702780A May 28 - May 30 Price Ea. \$ 8.75

Closed Cab Pickup Standard Window Riser Escutcheon

This is the standard escutcheon which fits between the window riser handle and the upholstery.

1-5/8" diam. x 5/8" high. 1928 - Mid '30 Closed Cab Pickup



A48139AR 28-30 Price Ea. \$ 2.95

Closed Cab Pickup Window Riser (Scroll Type)

The deluxe closed cabs used this scroll window riser used on:

June 30 - 31 Closed Cab Pickup

Order the A46250P to secure the handle.

Order A48139B Escutcheon.



A702780B 28-31 Price Ea. \$ 9.35

Mike's "A" FORD-ABLE Parts

Closed Cab Pickup Door & Window Riser Pins

A set of four pins, 1/8" diam. x 5/8" long, for the inside window Riser.



A46250P Price Set/4 \$ 0.65

Closed Cab Pickup Spring Loaded Window Riser Escutcheon

A replacement style that can be used in place of the A48139AR or the A48139B Escutcheons. Brushed chrome finish. I.S. is 11/16". Can be collapsed to a thickness of 15/32" or out as much as 5/8".



A48139RE 28-31 Price Ea. \$ 4.00

Closed Cab Pickup Deluxe Window Riser Escutcheon

This is a chrome plated deluxe style escutcheon which fits between the window riser handle and the upholstery.

Used on:
March '30 - 31 Closed Cab Pickup



A48139B 28-31 Price Ea. \$ 2.95

Closed Cab Pickup Upholstery Clip

These clips are made to hold the upholstery to the door on the Pick-Ups.



A46126 28-31 Price Set/10 \$ 2.50

Closed Cab Kick Panel Retaining Clip

These clips hold the bottom of the kick panel snug.

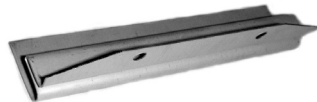

A40555CL 28-31 Price Pair \$ 5.75

Closed Cab Pickup Door Panel Nail

Pebble finished large headed nail to hold the door panel in place, with plastic holder.



A32180 Price Each \$ 0.70

Closed Cab Pickup Window Regulator

This good quality window regulator is the three-hole type used on the Closed Cab Pick-Ups.



A48105A 28-31 Passenger Side Price Ea. \$ 36.95

A48106A 28-31 Driver's side Price Ea. \$ 36.95

Closed Cab Pickup Window Regulator Bolts

This set of countersunk screws with star washers will attach the window regulators on both doors of the pickups.

3 x 1/4 -20 x 5/8.



A48105MB 28-31 Price Set/6 \$ 1.50

Closed Cab Pickup Window Regulator Spring

Mike also has this separate main spring of the window regulator in case that's all you need.



A48405/6 28-31 Price Ea. \$ 5.80

Closed Cab Pickup Header Strips

Mike has these pairs of header strips which screw into the frame above the door.



A45890A 30-31 Pickup Price Pair \$ 26.25

Closed Cab Pickup Header Strip Screws

This set has enough screws to attach the pair of header strips on your car or pickup. #8 1" Oval Wood Screws.



A45890MB 28-31 Price Set/12 \$ 1.25

PICKUP

Mike's "A" FORD-ABLE Parts

Closed Cab Pickup Header Strip

This part goes on the inside of the door header, nailed to the underside of the header with the lip pointing down. This piece is nailed in place first and then the header strip. The **A45890MB** is screwed to the header with the windlace under the **A45890MB** sandwiched between it and the **RAR238**.



RAR238 30-31 Price Ea. \$ 9.25

Closed Cab Pickup Door Top Cover Plate

This stamped steel plate covers the top of the door where the side glass stops.



A45883A 30-31 Pickups Price Ea. \$ 39.95

Closed Cab Pickup Door Top Cover Plate Screws

This 6 piece set of screws holds the top cover plate to the top of the door.
6 x 10/32 x 3/8 Flat Head Screws.

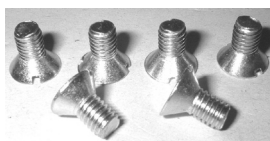

A45883MB 28-31 Price Set/6 \$ 1.10

Closed Cab Pickup Upper Door Seal

This is an aluminum channel with rubber insert that fits under the garnish moldings. The rubber rests against the window glass to maintain a seal as it goes up and down.



A19008A 30-31 Pickup Price Pair \$ 8.50

Closed Cab Pickup Rubber Insert for Upper Door Seal

If you are only needing to replace the insert in your channel (**A19008A**), this will do the job. Used on: '30-'31 Pickup



A19008R 30-31 Price Ea. \$ 2.80

1928 - 1931 Position of Window Felt Channels and Regulators

Top Window Cushion - Page P/UP 50
A45985

Felt Glass Channels
A45983 - Page P/UP 49 - Also
See the Felt Metal Retainer on
Page P/UP 50.

Metal Glass Channel - Page P/UP 50
A45962

Window Regulator
A48105 - Page P/UP 48

Metal Retainer
- Page P/UP 50.

For Glass See Page P/UP 31.

Closed Cab Pickup Economy Window Channel Kit

Unassembled kit for you to put together yourself. One kit does one door ONLY. Kit contains: 2 - 32" felt channels, 1 - upper sponge rubber, 2 - upper clips, 2 - lower clips and 8 - rivets.



A45983S 30-31 Only Price Kit \$ 16.50

Closed Cab Pickup Front Door Window Channel Kits

These kits include all of the necessary moulded channels with clips attached, upper window sponge seals, "T" shaped anti-rattle rubber (when required), lower glass cushion bumpers and adhesive. One kit does both front doors.



A45983A 30-31 Pickup Price Kit \$ 49.50

A45983PU 28-29 Pickup Price Kit \$ 55.00

Closed Cab Pickup Felt Glass Channel Clip

This clip goes at the bottom of each felt glass-channel to hold them in place. 2 Clips. These come with the complete kits above.



A45983CL Price Pair \$ 1.50

PICKUP

Mike's "A" FORD-ABLE Parts

Closed Cab Pickup Top Window Cushion

Attach this 30" strip of sponge rubber to the top of the window track with any good auto trim adhesive.

Forms a good cushion and seal.

These are included in the complete window channel kits - see Page P/UP 49.



A45985 28-31 Price Ea. \$ 2.25

Closed Cab Pickup Glass Bumper

This rubber bumper mounts on the ledge inside the door for the side window glass channel to rest on.

These are included in the complete window channel kits - See Page P/UP 49.

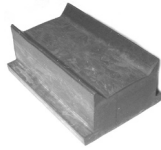

A48141 28-31 Price Ea. \$ 0.90

Closed Cab Pickup Door Window Felt Metal Retainer

Spot Weld this metal "U" channel to the edge of the door to hold the glass felt in place. One tubular rivet is included to attach the bottom. 16 1/2" Long.



Mid 1930 - 1931 Pickups.

A55980	30-31	Hinge Side is the same on both doors	Price Ea. \$ 10.25
A55981	30-31	Lock Side - Right Door	Price Ea. \$ 10.25
A55982	30-31	Lock Side - Left Door	Price Ea. \$ 10.25

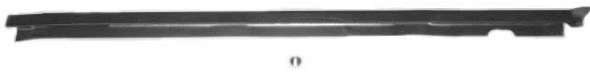

1928 - 1929 Deluxe Delivery.

A45980	28-29	Hinge Side - Right Door	Price Ea. \$ 10.25
		Lock Side - Left Door	
A45981	28-29	Hinge Side - Left Door	Price Ea. \$ 10.25
		Lock Side - Right Door	

Closed Cab Pickup Metal Glass Channel

This metal channel holds the bottom of the door glass and the window regulator fits into the slot on the bottom. Good for both sides, this fits all 1930-1931 Trucks.



A45962 30-31 Trucks Price Ea. \$ 9.35

Closed Cab Pickup Metal Glass Pick-Up Truck Channel

This is the window channel you will need for a '28-'29 Closed Cab Truck.



A45963T 28-29 Price Ea. \$ 28.75

Closed Cab Pickup Rear Glass Setting Rubber

This U-shaped rubber is used to mount the rear windows in the frame.



A19003R Price Ea. \$ 4.95



1931 Deluxe Roadster Pickup built by Mike's "A" Ford-Able Parts on request of a customer. As we previously mentioned, the folding top is not original but is available.

PICKUP

INSULATION

Roadster & Closed Cab Pickup Firewall Insulator

If you tour in the heat of the summer (and who doesn't?), you'll want one of these insulators to keep engine heat out. It mounts inside the firewall and is molded to look like the firewall.

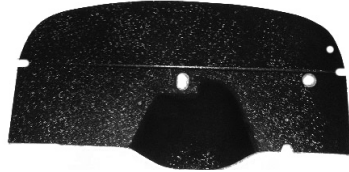

A18572A	28-29	Price Ea.	\$ 120.00
A18572B	1930 - 1931	Price Ea.	\$ 120.00
A18572C	1931 - Indented	Price Ea.	\$ 120.00

Complete Pickup Insulation

A multi - stage, automotive sound damping and insulation system for your Pickup. Reduce engine and road noise, vibration and heat. This is the stuff that Henry Ford left out of original production and it makes all the difference in driving comfort! Should be able to install in approx. 2 hours. Complete instructions included. These are shipped directly from the manufacturer to you.

1928 - 1929 Roadster Pickup

A18875	Complete Kit	Price Set	\$ 229.00
A18875A	Floor Kit	Price Set	\$ 89.00
A18875B	Rear Cab Kit	Price Set	\$ 79.00
A18875C	Cowl Kit	Price Set	\$ 29.00
A18803	Door Damper Kit	Price Set	\$ 49.00

1928 - 1929 Closed Cab Pickup

A18880	Complete Kit	Price Set	\$ 289.00
A18880A	Floor Kit	Price Set	\$ 89.00
A18880B	Roof Kit	Price Set	\$ 89.00
A18880C	Rear Cab Kit	Price Set	\$ 69.00
A18880D	Cowl Kit	Price Set	\$ 29.00
A18801	Door Damper Kit	Price Set	\$ 29.00

1930 - 1931 Roadster Pickup

A18890	Complete Kit	Price Set	\$ 229.00
A18890A	Floor Kit	Price Set	\$ 89.00
A18890B	Rear Cab Kit	Price Set	\$ 79.00
A18890C	Cowl Kit	Price Set	\$ 29.00
A18803	Door Damper Kit	Price Set	\$ 49.00

1930 - 1931 Closed Cab Pickup

A18895	Complete Kit	Price Set	\$ 209.00
A18895A	Floor Kit	Price Set	\$ 89.00
A18895B	Rear Cab Kit	Price Set	\$ 69.00
A18895C	Cowl Kit	Price Set	\$ 29.00
A18801	Door Damper Kit	Price Set	\$ 29.00

1928 - 1929 Panel Delivery

A18885	Complete Kit	Price Set	\$ 379.00
A18885A	Front Floor Kit	Price Set	\$ 89.00
A18885B	Rear Floor Kit	Price Set	\$ 89.00
A18885C	Rear Door Kit	Price Set	\$ 69.00
A18885D	Cowl Kit	Price Set	\$ 29.00
A18885E	Roof Kit	Price Set	\$ 109.00
A18801	Door Damper Kit	Price Set	\$ 29.00



The customer requested that the spare be put onto the right hand side to make entering the vehicle easier.

PICKUP

Mike's "A" FORD-ABLE Parts

GAS TANK

Specifications:

Steel thickness: .049" to .051" (terne plated)
Capacity: 28-29, 10 gal.; 30-31, 11 gal.

The following new parts are required to complete a restoration of your Gas Tank. This is only a guide - do not assume that this is all that is needed, all other parts need to be thoroughly checked.

1. Gas Tank Sealer - AGTS
2. Fuel Tank Welt Anti-Squeak - A9006
3. Gas Tank Filler Screen - A9020
4. Fuel Shut Off - A9189A or B
5. Fuel Shut Off Filter - A9193T or A9194B
6. Filter in Gas Bowl - A9156
7. Gas Lines - A9230A, B, A9230AV, BV, A9240B, C
8. Gas Gauge Tool - T9300
9. Gas Gauge Rebuilding Kit - A9320S
10. Gas Gauge Nut - A9326 - Inner - A9330 - Outer
11. Intake and Exhaust Manifold Gaskets - A9433F, A9433, A9433C, A9433C2
12. Carb Kit - A9595Z, B or T
13. Grose Jet - A9564GJZ, GJT or B9564Z
14. Choke Rod Assembly - A9700B or C
15. Grommet Set - A9066A or A9715/17
16. Control Rods - A9740S
17. Sediment Bowl - A9155
18. Sediment Bowl Gaskets - A9173 or N

Gas Tank Sealer

Extend the life of your old tank with this semi-elastic sealant. Seals pin holes, covers rust flakes, not affected by alcohol. Cannot be shipped by air. For best results, have the gas tank chemically cleaned and rust free before using this sealer.



AGTS 28-31 Price Quart \$ 25.00

Gas Tank Etching

Remove light rust inside of your gas tank before you put in the AGTS Gas Tank Sealer. This will leave a gray phosphate coating. 16 Oz.



A9002E 28-31 Price Each \$ 11.75

Cowl Welt

This roll of 1/8" black beading is used when you mount your gas tank.

'28-'29 Across back edge of tank and down sides of cowl.
'30-'31 Around back edge and sides.
Paint lower body color.



A3405CW 28-31 10 Ft. Roll Price Roll \$ 3.75

Gas Tank Anti-Squeak Welt

This 1/16" x 12 ft. woven fabric welt is used as a buffer around the gas tank to eliminate rattles. The early models use it all the way around the tank; the later models on the front and back edges.



A9006 28-31 Price Roll \$ 3.60

Gas Tank Filler Screen

This tab-style screen sits in the neck of the gas tank. Does not fit early threaded style. See page 441 of Service Bulletins for correct installation.



These will **not** work with tool - T9021 - A9020 28-31 Price Ea. \$ 10.45

Gas Tank Filler Screen Tool

A great tool to help with the installation or removal of the Filler Screen (A9020). Place the tool in the filler neck notches and use a socket wrench and extension.

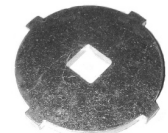

For original Screens Only.
T9021 28-31 Price Ea. \$ 3.75

Gas Tank Protector

Lay this lined naugahyde on top of the tank when filling to protect your finish.



A9030P 28-31 Price Ea. \$ 11.95

Gas Tank Speedo Cable Grommet

This elongated grommet will help save your cable that runs under the gas tank in the tunnel to the speedo.



A9066R 28-29 Price Ea. \$ 3.40

Firewall to Gas Tank Screws

This set of screws has all the parts needed to attach the gas tank to the firewall. Paint lower body color.

10 12-24 x 19/32 Pan Head Screw & Lockwasher.



#46 30-31 Price Set \$ 2.00

PICKUP

P/UP-52 Give us a call - 1-888-TRY-MIKE (879-6453) **Have an "A" Day!**

Mike's "A" FORD-ABLE Parts

Firewall to Gas Tank Bolts

This set of bolts is what you'll need to attach the gas tank to the firewall.

8 x 3/8 Tall Headed 1/4 - 20 5/8" Bolts, Lockwashers & 1/2" Nuts.

Paint lower body color.



#46A 28-29 Price Set/8 \$ 4.10

Gas Tank To Belt Rail Bolts

This set of bolts is what you'll need to attach the gas tank to the cowl. Bolts secure the back edge of the tank to the dash rail support.



#46B 28-29 1/4-20 x 1/2" Bolts, LW's & Hex Nuts
Price Set/24 \$ 3.85



#46C Early 1930 12 x 1/4" - 20 3/4" Bolts & l.w.
Price Set/36 \$ 3.85



#46D Mid 1930 Size changed to 5/16-24 x 25/32" Bolts, LW's and Nuts.
Price Set/36 \$ 3.85



#46E Late 1930 to End -
The same 5/16-24 x 25/32" Bolts were used, except the nuts were placed inside a cage. Unfortunately these cage nuts are no longer available.
Price Set/24 \$ 4.85

Gas Cap

Vented gas cap in the style used for '28-'29 cars. Chrome over brass. Includes gasket.



A9030A 28-29 Price Ea. \$ 17.90

Show Quality Gas Cap

Vented stainless steel gas cap for '30-'31. This is the best quality available. It's a copy of the original Eaton style cap. These really fit. Includes the correct gasket.



A9030C 30-31 Price Ea. \$ 16.25

Gas Cap Gaskets

Treated leather gaskets.



A9035A 28-29 Price Ea. \$ 0.65



A9035 30-31 Price Ea. \$ 0.95

Sediment Bowl Repair Kit

Rebuild kit to improve the functioning of original cast iron sediment bulb on the firewall. Instructions included.



A9155RK 28-31 Price Kit/3 \$ 4.75

Glass Sediment Bowl Micro Filter

Improve the efficiency with this filter which fits inside the glass bowl. Instructions included. Can only be used with A9155 - See Page P/UP 54.



A9156 28-31 Price Set/3 \$ 4.50

Sediment Bowl Screen

This brass screen fits between the bowl gasket and the bulb housing on the glass sediment bulbs

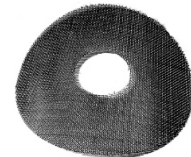

A9155SC 28-31 Price Ea. \$ 1.65

PICKUP

Mike's "A" FORD-ABLE Parts

Sediment Bowl Assembly

Glass sediment bowl was originally an option from **Mid '29** but will work on all A's, except for indented firewalls.

Gasket (A9173 - below) and Screen (A9155SC - Page P/UP 53) are included. Use Micro Filter (A9156 - Page P/UP 53) in this Bowl. A9155 28-31 Price Ea. \$ 26.95



Late '31 Filter Kit

Use this kit if you are NOT running the correct side-bowl style Zenith Carb. Designed to accommodate the late **1931** Model A's with the gas valve on the firewall. Includes a glass bowl type sediment bulb along with gas lines and fittings to install. The copper sediment bowl screen can be replaced by using A9155SC.

A9155L 1931 Price Kit \$ 27.95

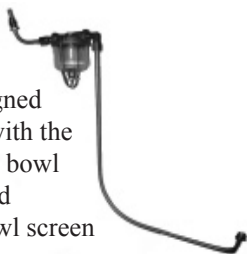

Sediment Bowl Gaskets

For the glass sediment bowl. Neoprene should be replaced when you remove the bowl.

A9173 28-31 Cork Price Ea. \$ 0.30



A9173N 28-31 Neoprene Price Ea. \$ 0.45



Sediment Bowl Glass

Replace your discolored bowl with a new clear one.

A9158 28-31 Price Ea. \$ 5.50



Side Bowl Filter

On the late '31 A's, Ford moved the filter to the side of the carburetor. Complete with all hardware.

A9161 1931 Price Set \$ 47.95



Side Bowl Filter Without Hardware

If all you need is the side bowl filter, and not all of the hardware.

A9161A 1931 Price Ea. \$ 33.00



1928 to 1931 Cast Iron Sediment Bowl

7/8 - 14 Nut (1-1/4 Wrench) A9156A

Lock Washer

These three items are not available new.

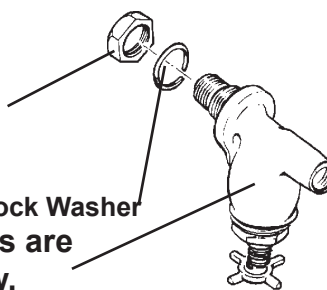

Mid 1929 to Early 1931 Glass Sediment Bowl

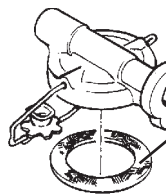

Cork / Neoprene Gasket - A9173 & N

Screen - A9155SC

Glass Bowl - A9158

Special Nut (No Lock Washer) - Not Available

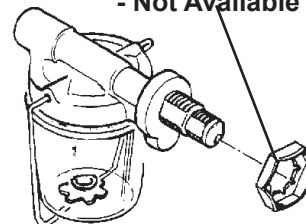

Thanks to Les Andrews for the use of his drawings.

Side-Bowl Rebuild Kit

With this you can rebuild your side bowl filter. Mounted on the side of the carb.

A9161SC Late 1931 Price Kit/3 \$ 2.10



Side Filter Bolt

This is the special bolt to hold the side bowl filter to the carb on the late '31 A's.

A9161B 1931 Price Ea. \$ 4.25



Side Bowl Drain Valve and Spring

For the late '31 A's, this drain needle with spring screws into the bottom of the filter.

A9161V 1931 Price Ea. \$ 5.95

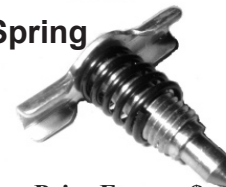

Sediment Bowl Brass Cap Plug

For Cast Iron bulbs. Goes into the bottom of the cast iron sediment bulb and A9177 (Page P/UP 55P) threads into it.

A9175 28-31 Price Ea. \$ 8.50



PICKUP

Mike's "A" FORD-ABLE Parts

Sediment Bowl Brass Drain Valve & Forged Drain & Spring.

For Cast Iron bowls.



A9177 28-31 Price Set \$ 11.95

Installation of Repair Kit for Cast Iron Bowl

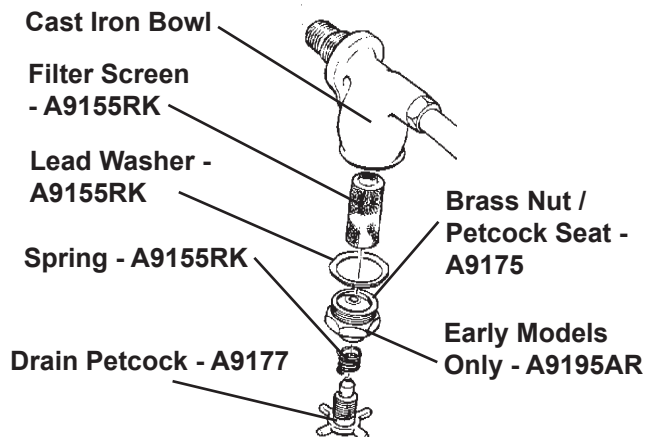

Fuel Shut off Valve

This all brass valve is inside the car to shut the gas off going to the carb.



A9189A 28-31 Price Ea. \$ 29.95



Installation of Fuel Shut Off & Gas Tank Screen (A9193T) into A9189A

Gas Tank Screen (Fuel Shut Off)

This screen presses into the gas shut-off valve where it goes into the gas tank to keep sediment and rust out of the carb.



A9193T 28-31 Price Ea. \$ 2.95

Fuel shut Off Valve Packing Nut

This brass nut holds the packing in place the sediment bulb.



A9195AR

A9195AR	1928 - late 1929	Price Ea.	\$ 3.00
A9195B	1929-1931	Price Ea.	\$ 2.50

Late '31 Gas Shut Off Valve

This all brass valve was used on the late '31 A's with the indented firewall. This is fitted onto the firewall in the engine compartment.



A9189B 1931 Price Ea. \$ 36.95

Electric Fuel Cut Off Don't Leave this off!!!!

How often have we forgotten to switch off the gas. Well now you don't have to, just leave your gas on and let the Electric Fuel Cut Off do the job for you. Made to go on your 1/4" fuel line that runs from the firewall to the carburetor. Simply Turn the key On or off - THAT'S IT. Comes with Complete instructions.



Available in 6 or 12 Volt.

A9189	28-31	6 Volt	Price Set	\$ 49.95
A9189/12V	28-31	12 Volt	Price Set	\$ 49.95

Fuel Valve Grommet

For the late '31 valves that mount on the firewall, you'll need this excellent repro. to go in the hole.



A9171 1931 Price Ea. \$ 1.95

Gas Shut Off Fuel Valve Handle Only

Handle only for the earlier (A9189A) shut off valve.



A9189H 28-31 Price Ea. \$ 2.95

Gas Shut Off Fuel Valve Handle Only

This is the forged style handle used from the beginning until April 1929.



A9191A 28 - April 29 Price Ea. \$ 10.00

Gas Shut off Valve Packing

If your shut off valve isn't shutting off, try replacing the packing before buying a new valve.



A9193 28-31 Price Ea. \$ 0.95

Mike's "A" FORD-ABLE Parts

Gas Valve Repair Kit

Use this complete kit to rebuild the original style gas valve. Includes packi jam nut, lock washer and gas resistant lubricant. Will also fit late '31's.



A9193S 28-31 Price Set/4 \$ 2.50

Inside Gas Lines

This line connects the gas valve under the gas tank to the sediment bowl on the firewall. 5/16" tubing.



A9230A 28-29 Price Ea. \$ 7.50

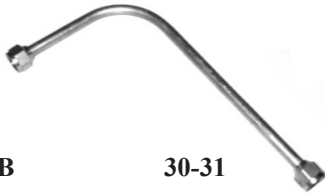

A9230B 30-31 Price Ea. \$ 5.35

Modern Gas Line Valve

If you are having continuous trouble with your gas line valve - we now have a modern valve in line - this guarantees a complete shut off with a quarter turn of the handle. Leave your A9189A or B in place and then attach the A9230AV or BV.

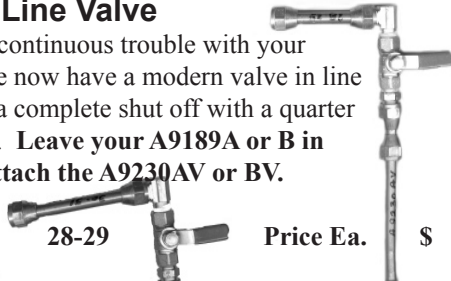

A9230AV 28-29 Price Ea. \$ 55.00

This is an excellent solution to a leaking gas problem.

A9230BV 30-31 Price Ea. \$ 55.00

Gas Line

This line with brass fittings connect the sediment bulb to the carb. Not for the late '31's A's.



A9240B 28-31 Price Ea. \$ 4.50

For the late '31's with indented firewalls and side bowl carburetors. Includes Fittings.



A9240C 1931 Price Ea. \$ 4.60

Gas Line Fitting

Like the original brass gas line fittings.



A9243 28-31 Price Ea. \$ 1.00

Gas Line Fittings

Like the original 9/16 head fittings used on the late '31 A's. Set ferrul no more than 1/8" from the end of the tube.

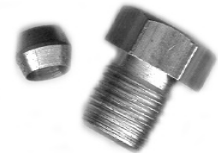

A9243B 1931 Price Set \$ 2.80

Gas Tank Clamps

Hold the bottom of the gas tank stable with these. 5 per side needed for '28-'29; 2 per side needed for '30-'31.



A35266AR 28-29 10 Needed Price Ea. \$ 2.30



A35266BR 30-31 4 Needed Price Ea. \$ 2.40



1930 Closed Cab Pickup 82B also with Mike's preference of the spare on the right hand side for ease of entry.

PICKUP

GAS GAUGE

Tool Set

Safely work on your gas gauge with this cast aluminum heat treated tool set. Will not damage nuts.



T9300 28-31 Price Set/2 \$ 6.45

Gas Gauge Assembly

Complete assembly
Inner and Outer Nut &
Gaskets.

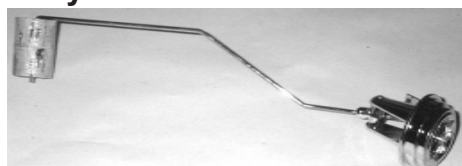

A9312D 28-31 Price Set \$ 36.30

Gas Gauge Assembly

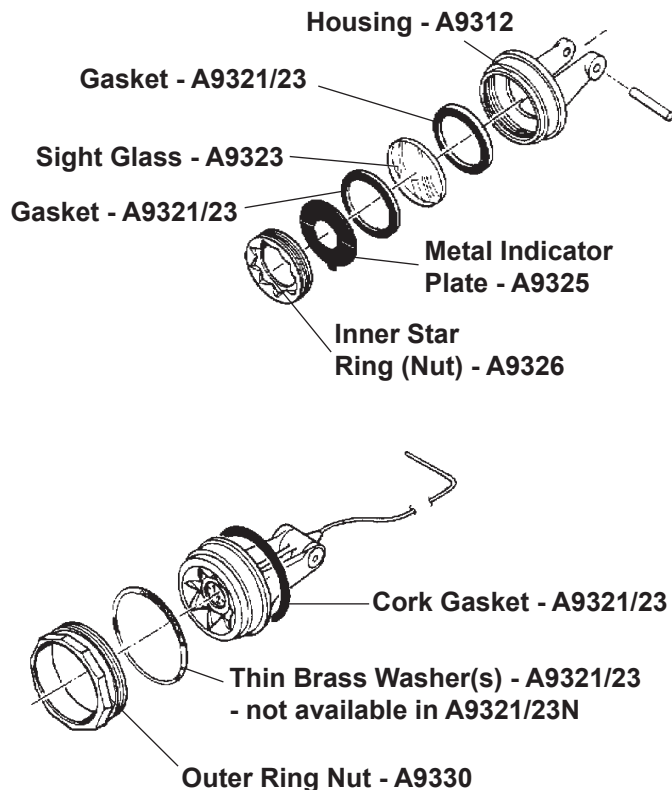

Thanks to Les Andrews for the use of his drawings.

Gas Gauge Rebuilding Set

This set includes cork gaskets, lens, face plate and cork float. The order is gasket, glass, gasket, face plate, inner nut. Large gasket against tank, gas gauge assembly, brass washer & outer nut.

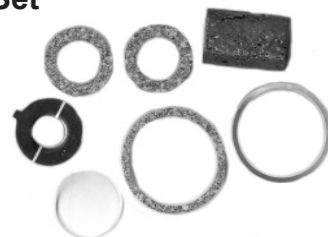

A9320S 28-31 Price Set/9 \$ 5.95

Gas Gauge Cork Float Only

You can buy this cork float separately if its all you need.
Treated to resist gas.



A9312F 28-31 Price Ea. \$ 1.95

Gas Gauge Neoprene Float

You can now get a Gas and Alcohol proof float to eliminate the problem of having your cork float disintegrate over time in the gas.



A9313B 28-31 Price Ea. \$ 4.45

Gas Gauge Brass Float

Modern style gas float based on the design of a carburetor float. You should never have any trouble with this.



A9313C 28-31 Price Ea. \$ 9.95

Gas Gauge Gaskets

Choose between cork like Ford used or modern neoprene.

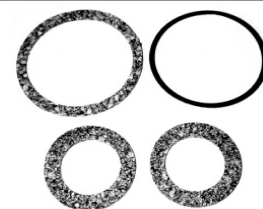

A9321-23 28-31 Cork Price Set/4 \$ 1.25

A9321-23N 28-31 Neoprene Price Set/4 \$ 1.75

Gas Gauge Lens

Glass lens.

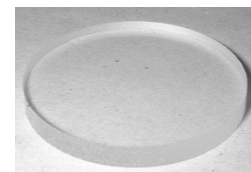

A9323 28-31 Price Ea. \$ 0.95

Gas Gauge Face Plate

Like the original.

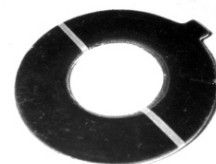

A9325 28-31 Price Ea. \$ 1.50

PICKUP

Mike's "A" FORD-ABLE Parts

Gas Gauge Inner Nut

Chrome Finished inner nut for the "A" gas gauge.



A9326 28-31

Price Ea. \$ 6.55

Gas Gauge Outer Nut

Chrome finished outer nut for the "A" gas gauge.



A9330 28-31

Price Ea. \$ 6.75

"B" Fuel Pump Rebuild Kit

A complete rebuild kit for your '32-'34 4 cy. fuel pump.

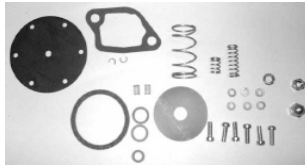

B9349A 32-34

Price Set \$ 39.95

"B" Fuel Pump Gasket

This gasket goes between the block and the fuel pump on a "B" 4 cyl. engine.

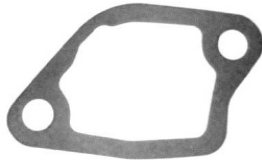

B9374 32-34

Price Ea. \$ 1.00

"B" Fuel Pump Diaphragm

Included in the B9349A kit.

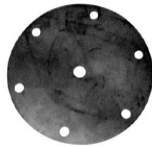

B9390 32-34

Price Ea. \$ 4.95



1930 Panel Delivery 79B. This vehicle was found in Alabama in 1997 by a customer who took Mike to see it. It was love at first sight. It was completely restored and finished in 2000, and is now a part of the family.



PICKUP

Mike's "A" FORD-ABLE Parts

SPEEDOMETER

Speedometer Mount Set

This set of 2 screws, nuts, and lock washers is used to mount your speedometer to the instrument panel.



A17255MB 28-31 2 x 1/4" - 20 x 1/2" screws + 1/2" square nut & lock washer
Price Set/4 \$ 0.80

Rebuilt Speedometers

Sold on EXCHANGE ONLY. Mike must have your complete re-buildable core to ship a rebuilt one out.

NO OUTRIGHT SALES.

NO EXCEPTIONS.

Only Stewart Warner Speedometers are still being rebuilt.



A17255AS	28-30	Oval face	Price Ea.	\$ 225.95
A17255BS	30-31	Round face	Price Ea.	\$ 225.95

Speedometer Bezel Rim - Nickel

Shiny new face plate to replace that cracked or broken plate.



A17259A	28-30	Oval S/W	Price Ea.	\$ 19.95
A17259C	June '30-31	Round S/W	Price Ea.	\$ 16.75
A17259D	June '30-31	Round Waltham	Price Ea.	\$ 16.95

Speedometer Lens

If your old glass lens has gotten scratched or dingy over the years, replace it with one of these.

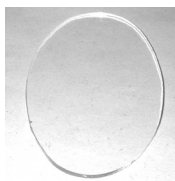

A17256AR	Oval	Price Ea.	\$ 1.10
A17256B	Round	Price Ea.	\$ 1.00

Speedometer Lens Gaskets

Mike also has new gaskets for the speedometer lens.



A17257AR	1928 - June '30	Oval face	Price Pair	\$ 1.15
A17257B	July '30 - 1931	Round face	Price Pair	\$ 1.15

Speedometer Lens Retainer

This ring holds the lens into the chrome face for the round speedometer.

Sorry not available for Oval Lenses.



A17258B	30-31	Price Ea.	\$ 3.25
---------	-------	-----------	---------

Speedometer Face Plate

This is the black plate that fits behind the chrome facing on the Speedometer.

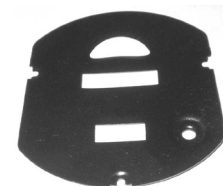

A17268A	28 - June 30	Oval speedo	Price Ea.	\$ 6.20
A17268C	June 30 - 1931	Rnd Stewart Warner	Price Ea.	\$ 6.80
A17268D	June 30 - 1931	Round Waltham	Price Ea.	\$ 7.85

Speedometer Decals

Replace your tired number decal with the right new one.

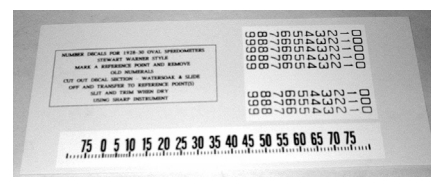

A17255A	'28- June '30	Oval Faces Speedo	Price Ea.	\$ 2.75
A17255B	July '30-31	Round Faced Stewart Warner - 7/8" Wheel	Price Ea.	\$ 2.75
A17255C	July '30-31	Round Faced Waltham - 3/4" Wheel	Price Ea.	\$ 2.75
A17255D	July '30-31	Round Faced Northeast	Price Ea.	\$ 3.00

Mike's "A" FORD-ABLE Parts

Speedometer Calibration by Wiley Higgins

While driving a Model A, the optimum driving speed is a steady 45 MPH. This speed moves you along at a good pace and helps keep you out of the way of most traffic, while not putting too much strain on your engine. If your Model A won't hold a steady 45 M.p.h., something needs to be corrected.

First of all, a Model A Speedometer usually is *not accurate* after over 60 years of use, even it has been rebuilt by a professional. Also, tire size and rear-end ratio have an effect. So, your speedometer may indicate a different speed than you are actually travelling down the road - either faster or slower.

The best method of determining the **actual speed** you are travelling is to **conduct a time/distance check**. Here's how:

1. Select a reasonably **straight and level stretch** of highway.
2. Use your digital or sweep second hand watch as a stop watch.
3. As you pass any **mile post** (remember, straight and level is best), start the stop watch or note the seconds on the sweep second hand.
4. **Hold the same, steady speed for one mile** to the *next* mile post, and **note how many seconds have elapsed**.
5. **Consult the chart** below to determine your true speed over the ground.
6. **Repeat steps 1. through 5.** above two or three times and **get an average**.
7. Adjust your speed over the ground slower or faster if you have a speedometer error to hold a steady 45 M.p.h.. For example, it takes **80 seconds** to go **1 mile** if your *true* ground speed is **45 M.p.h..**

SEC (1 Mile)	MPH	SEC (1 Mile)	MPH
102	35.3	86	41.9
101	35.6	85	42.4
100	36.0	84	42.9
99	36.4	83	43.4
98	36.7	82	43.9
97	37.1	81	44.4
96	37.5	80	45.0
95	37.9	79	45.6
94	38.3	78	46.2
93	38.7	77	46.8
92	39.1	76	47.4
91	39.6	75	48.0
90	40.0	74	48.7
89	40.5	73	49.3
88	40.9	72	50.0
87	41.4		

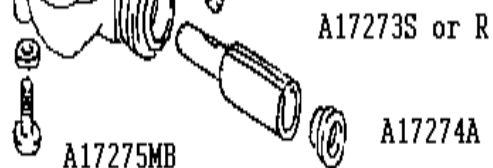
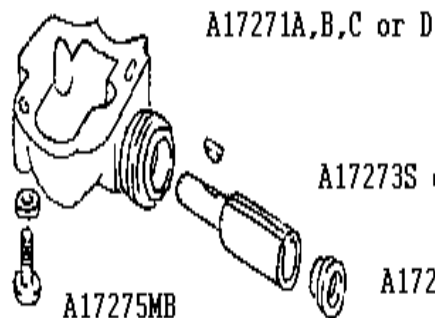
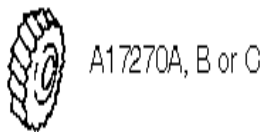

A17275MB

A17274A or B

Speedometer Trip Stem

Nickel plated, knurled stem that pulls out on the Oval Speedo to set the odometer. Complete stem assembly with gear and retaining washer.



A17267 28 - Mid 1930 Price Set \$ 20.00

Speedometer Mainspring

This mainspring goes inside your speedometer.



A17318 Waltham Price Ea. \$ 7.75

Speedometer Grommet

This speedometer grommet fits in the firewall for the cable to go through, next to the choke rod.



A14567 28-31 Price Ea. \$ 0.75

PICKUP

Mike's "A" FORD-ABLE Parts

Gas Tank Speedometer Cable Grommet

This elongated grommet will help save your cable that runs under the gas tank in the tunnel to the speedo.



A9066R 28-29 Price Ea. \$ 3.45

Water Inlet - Speedo Cable & Cut-out Wire Clip

This wire clip was used in several places by Ford: for the water inlet and speedometer cable inside the firewall for all years; for the cutout wire on the firewall in 30-31.



A14577A 28-31 Price Ea. \$ 1.50

Firewall Wire Clip Bolt (Round)

This is the correct round head screw with lock washer to attach the wire clip to the firewall.

Paint Black. Use with A14577A & B - Page Gen. 196.

A14577BR 28-31 12/24" x 1/2" screw & l.w.



Price Set/2 \$ 0.40

Speedometer Cables

Due to the fact that there are several manufacturers of interior cables and they are all being reproduced in different lengths, thereby causing a lot of confusion and problems we are no longer stock inner cables seperatly.

Replace your worn out speedometer cable with one of these new complete assemblies with steel ends. Mike's note: The early Ford cable was 1/2" in diameter while the latter was 1/4". The early gear on the drive shaft key has a round cable end with key up. The '30-'31 accepts the square cable.



Speedo End Square - Drive end Keyed
A17260AU 1928 - June '30

USA (oval)
Price Ea. \$ 33.95

Speedo End Square - Drive end Square
A17260B July '30 - 31

USA (round)
Price Ea. \$ 26.95

Black Vinyl Covered Speedometer Cable

An inexpensive alternative to the original flexible cables. For the round speedometer. This cable was not original but is a less expensive alternative to the A17260B and does the job.



A17260C 30 - 31 Price Ea. \$ 15.00

Speedometer Lube

If your cable is OK but not turning smoothly, get this 7cc packet of graphite lubricant.



A17260L 28-? Price Ea. \$ 2.95

Speedometer Support Clip

This support clip with mounting hardware goes on the frame rail to hold the speedometer cable.



5/16-24 x 11/16 Bolt, Lockwasher and Nut

A17265A 28-30 Oval speedo -
Price Ea. \$ 2.75

A17265B 30-31 Round speedo
Price Ea. \$ 2.75

Speedometer Drive Gears Only

Mike also has the drive gears available for both the 3.54 and 3.78 rear end gears.



A17270A 28-29 19 Tooth Gear used with 21" and 19" Tires
Price Ea. \$ 14.60



A17270B 30-31 18 Tooth Gear used 19" Tires
Price Ea. \$ 12.25

Extra High Speed Drive Gear

This gear goes in the speedo drive assembly that bolts to the bottom of the torque tube.

This is a high strength plastic 17 tooth gear that is used with the A4209XHS.

See Page Gen. 84.



A17270C 28-31 3:27 Ratio - 17 Tooth
Price Ea. \$ 29.95

Speedometer Housing Only

New Housings are now available.

Replace your worn housing with a new one.



A17271 28-31 Price Ea. \$ 41.00

Mike's "A" FORD-ABLE Parts

Speedometer Housing and Gear Assembly.

A complete new housing and gear assembly have been made from the FORD blue print. Includes gear, shaft and retainer. Order Gasket A17275 Separately.



- A17271A 1928 - June 1930 - Standard Gear with Round Hole Shaft for 21" Tire
Price Ea. \$ 56.95
- A17271B June 1930 - 1931 - Standard Gear with Square Hole Shaft for 19" Tire
Price Ea. \$ 56.95
- A17271C 1928 - June 1930 - High Gear with Round Hole Shaft for 21" Tire
Price Ea. \$ 56.95
- A17271D June 1930 - 1931 - High Gear with Square Hole Shaft for 19" Tire
Price Ea. \$ 56.95

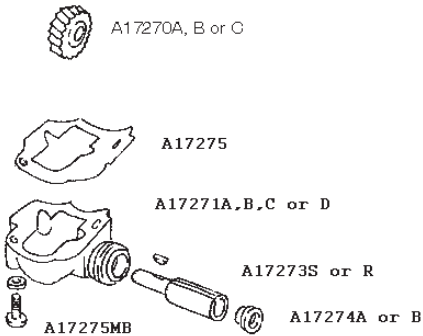

Speedometer Gasket

Here's a gasket to get the proper gear mesh on the gear case.

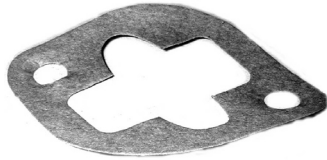

- A17275 28-31 Price Ea. \$ 0.50

Speedometer Gear and Case Mount Bolts

Mike has this set of two fine-threaded bolts with lockwashers to bolt the speedometer gear and case to the torque tube.



- A17275MB 28-31 2 x 1/4" - 28 x 1" bolts & l.w.
Price Set/4 \$ 0.60

Speedometer Drive Gear Shaft

The end of the speedometer cable slides into this shaft in the gear/case assembly that bolts to the torque tube. Square end (S) and Round end (R) available.



- A17273R 1928 - June '30
Round ended cable / Oval Speedo
Price Ea. \$ 12.95



- A17273S July '30 - '31
Square ended cable / Round Speedo
Price Ea. \$ 12.95

Speedometer Shaft Retainer

This retainer goes into the threaded end of the gear and case to prevent the shaft from coming out.



- A17274A 28 - July '30 - Short Retainer
Price Ea. \$ 1.40

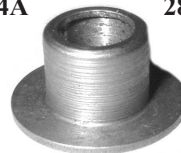

- A17274B July '30 - 1931 - Longer Retainer
Price Ea. \$ 1.40

Speedometer Snap Ring

This snap ring holds the speedometer drive gear and thrust washer in place on the drive shaft.



- A17286 28-37
Price Ea. \$ 0.75

Speedometer Thrust Washer

The thrust washer goes onto the drive shaft between the bearing and the speedometer drive gear.



- A17290 28-48
Price Ea. \$ 1.95

PICKUP

Mike's "A" FORD-ABLE Parts

MIRROR

Closed Cab Pickup Rear View Mirror Screws

This is the set of round headed machine screws to hold the mirror on the '28-'29

Closed Cab. 3 x 10-32 x 5/8 Round Head Screws with washers and nuts.

A17681AMB 28-29



Price Set/3 \$ 1.50

Rear View Mirror Mount Screws

This set of 3 chromed oval headed wood screws is used to mount the rear view mirror to the wooden header.

3 x #10 x 1" Oval Head Screw.

A17681BMB 30-31



Price Set/3 \$ 1.00

Inside Rear View Mirror Bracket Clip

These are the clips that hold the glass in place.



RAR252

Price Set/3 \$ 4.95

Closed Cab Pickup Mirror

This mirror has a black painted frame for the '28-'29 Closed Cab.



A17682AS 28-29 Black

Price Ea. \$ 19.25

Roadster Pickup Mirror

This mirror with frame is for the '28-'29 Open Cab.

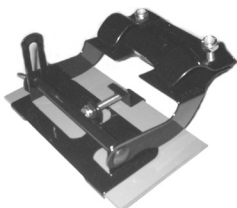

A17681AS 28-29 Black

Price Ea. \$ 21.95

Closed Cab Mirror

Mike has both the black and the Stainless rear view mirrors for the '30-'31 Closed Cab.



A17682BS 30-31 Black Price Ea. \$ 23.65

A17682SS 30-31 Stainless Price Ea. \$ 30.25

Roadster Pickup Cab Mirror

Mike has the stainless steel mirrors for the '30-'31 Open Cab.

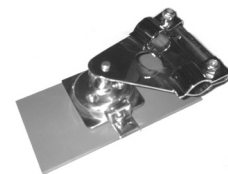

Open cab.

A17681SS 30-31 Stainless

Price Ea. \$ 30.25

Rear View Mirror Glass

If your mirror is cloudy or the plating has worn off, replace it with one of these quality beveled mirrors. The smaller is correct but the larger gives better visibility.



A17704 Original Size - 2-1/2" x 4 1/2"

Price Ea. \$ 5.50

A17704B 2-1/2" x 6"

Price Ea. \$ 6.50

1928-1929 Roadster Pickup Post Mirror

This screws into the screw hole that holds the windshield stanchion to the body of the '28-'29 Open Cabs.

5/16 - 24 Thread.

You must drill and tap for the '28-'29.

AR17700P 28-29 4" Glass

Price Ea. \$ 38.45



1930-1931 Roadster Pickup Post Mirror

This mounts on the flat area about halfway up the driver side stanchion on the '30-'31 Open Cabs.

7/16 - 20 Thread.

B17700P 30-31

Price Ea. \$ 38.45



Closed Cab Pickup Clamp On Mirror (Peep Mirror)

This mirror fits closed cabs by clamping onto the front of the door edge with two set screws. Chrome bracket with polished stainless mirror head.

4" Mirror.

A17741U 28-31

Price Ea. \$ 25.95



Closed Cab Peep Mirror

A chrome mirror that will easily attach in just minutes. Attach the two set screws to the top of the door. Can be used on either the driver or the passenger side door.



A17700PL 28-31

Price Ea. \$ 21.95

Give us a call - 1-888-TRY-MIKE (879-6453) **Have an "A" Day! P/UP-63**

PICKUP

Mike's "A" FORD-ABLE Parts

Closed Cab Hinge Mirror

This mirror with mounting pin fits all '28-'31 Closed Cabs. Chrome bracket with polished stainless mirror head that adjusts.



4" Mirror.

A17741A	28-29	Left or Right	Price Ea.	\$ 39.05
A17741BL	30-31	Left	Price Ea.	\$ 39.05
A17741BR	30-31	Right	Price Ea.	\$ 39.05

Hinge Mirror Head Only

If the hinge arms are still in good shape and all you need to replace is the mirror - these are now available.



B17741MH	28-30	Price Ea.	\$ 20.20
----------	-------	-----------	----------

Hinge Mirror Pin

This chrome finished pin will come with any new Hinge Mirror. This is a replacement in case you damage yours.



A17741HPI	28-31	Price Ea.	\$ 2.45
-----------	-------	-----------	---------

Sidemount Mirror

This style sidemount mirror is attached with a leather strap onto your side mounted spare wheel in the fender well. This was not originally used on a Pickup, but is up to you.



B17700SM	Price Ea.	\$ 47.30
----------	-----------	----------

Roadster Pickup Windwing Mirror

This stainless mirror clamps to the windwing glass if you choose to put windwings onto your Pickup.



B17700WWSS	28-31	Price Ea.	\$ 27.50
------------	-------	-----------	----------

Closed Cab Truck Hinge Mirror

This is a hinged style mirror for the Closed Cab Commercial vehicles. 5" Mirror Glass.



A17741AB	28-31	Price Ea.	\$ 31.00
----------	-------	-----------	----------

Closed Cab Post Mirror (Bolt On)

The '28-'29 Closed Cab Trucks can use this type mirror which mounts to the door post. 5/16-18 Acorn Nut.



A17700PU	28-29	5" mirror glass	Price Ea.	\$ 38.55
----------	-------	-----------------	-----------	----------

Mirror Head Only

A 5" diameter black mirror head for the Commercial Vehicles Only. Has a shouldered 1/4" male stud coming out the back.



A17700MH	28-31	Price Ea.	\$ 9.95
----------	-------	-----------	---------

Clock Mirrors

Mirror clocks are designed especially for the Model A Fords. Two of the outstanding features found in each Clock Mirror are the beautiful beveled quality mirror along with the accurate and dependable Quartz timepiece with its Arabic or Roman Numeral dial reflecting styles of the past. Comes with a 2 year manufacturer warranty. Please make sure that your bracket will adjust to hold a 2" high mirror. Shown on a bracket - this is NOT included.



A17705AS	Silver Arabic	Price Ea.	\$ 95.00
A17705AG	Gold Arabic		
A17705RS	Silver Roman Numeral		
A17705RG	Gold Roman Numeral		

Clock Mirror with Polished Edge

A beautiful replacement clock mirror with a polished edge. The mirror is not glass.



A17706	28-31	Price Ea.	\$ 39.95
--------	-------	-----------	----------

PICKUP

TAIL LIGHT

Specifications:

Parking, Tail: 3 CP, single contact Mazda 63
 Stop: 21 CP, single contact Mazda 1129

The following new parts are required to complete a restoration of your Tail Lights. This is only a guide - do not assume that this is all that is needed, all other parts need to be thoroughly checked.

1. Tail Light Rim - A13448SS
2. Tail Light Gasket Set - A13461
3. Replacement Screw Set - A13405SK
4. Lens - choose your style - A13450
5. Snap Rings - A13456
6. Licence Plate Lens - A13445
7. Retainer clips - A13446S
8. Tail Light socket Set -A13412S
9. Reinforcing Plate - A13463
10. Bracket to Fender Mounting Bolts - A13474B, SS
11. Tail Light Bracket/Fender Rubber Pad - A13520
12. Tail Light / Stop Light Bulbs - A13465 & A13466
13. Licence Plate Bolt - A13407MB
14. Stoplight Switch - A13480A or B

Duo-Lamp Tail Light Repair Parts

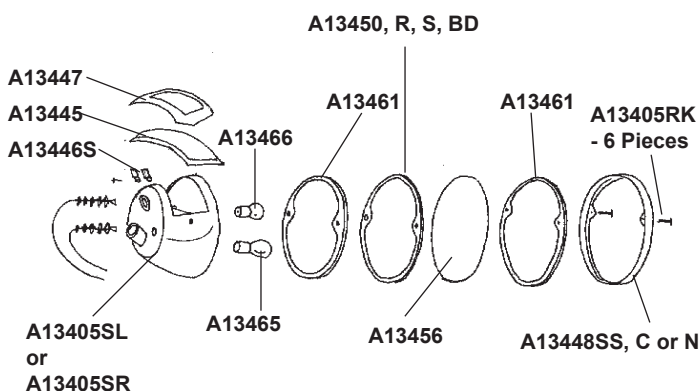

"Duolamp" Tail Light

Copy of the original. Stainless Steel. Commercials used black painted - left side has white lens - right side, no lens. Complete with half amber lens, bulbs and wiring - also includes bracket screws.



A13405SL	28-31	Left	Price Ea.	\$ 37.95
A13405SR	28-31	Right	Price Ea.	\$ 37.95

"Duolamp" Tail Light Replacement Screw Kit

This is all of the screws that you will need to refurbish your Tail light. 1 Set per Tail Light.



A13405SK	28-31		Price Set/8	\$ 3.65
----------	-------	--	-------------	---------

Commercial Tail Light

These lamps have a black powder coated housing with a polished stainless rim as was used on commercial vehicles. These are Non Script.



A13405BL	29-31	Left	Price Ea.	\$ 42.00
A13405BR	29-31	Right	Price Ea.	\$ 36.00

Stop Light Bulb

21 Candle Power.

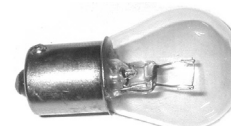

A13465	28-31		Price Ea.	\$ 1.00
--------	-------	--	-----------	---------

Tail Light, Parking Light, Cowl, Instrument Panel & Dome Light Bulb

3 Candle Power as original.

10 Candle Power is available if you would prefer a brighter bulb.



A13466/3	3 CP	Price Ea.	\$ 0.90
A13466/10	10 CP	Price Ea.	\$ 1.25

Quartz Bulbs

If you want a lot more light, use these direct replacements for your original bulbs. These are also known as "Ugly Bulbs".



Tail Light and Parking: 20 Watt

B13466Q6	6 Volt	Price Ea.	\$ 13.75
B13466Q12	12 Volt	Price Ea.	\$ 11.00

Stop Light: 50 Watt

B13465Q6	6 Volt	Price Ea.	\$ 13.75
B13465Q12	12 Volt	Price Ea.	\$ 11.00

Mike's "A" FORD-ABLE Parts

Tail Light Visor

Match up your Tail Lights with a visor set. Just like the headlight set - see Page Gen. 185.



A13001A 28-31 W/Jewel Price Pair \$ 23.00

Tail Light Rim

We only keep the stainless as these will not rust.



A13448SS 29-31 Stainless
Price Ea. \$ 5.75

LED Replacement Tail Light - All Red or Half Amber

Use this brand new product in your duo lamp housing and have the advantage of LED Tail lights. 6 or 12 Volt.

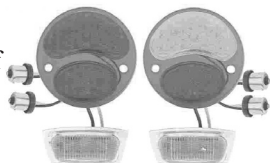

12 Volt
A13453 Right - Half Amber
A13453R Right - Red
A13454 Left - Half Amber
A13454R Left - Red Price Ea. \$ 40.00

6 Volt
A13455 Right - Half Amber
A13455R Right - Red
A13457 Left - Half Amber
A13457R Left - Red Price Ea. \$ 43.00

Tail Light All Red Lens

If your state does not allow amber stop lights, this all red lens is available.



A13450R 1928 - Sept. '29 Price Ea. \$ 5.45

Tail Light Half Amber Lens

This lens has a red section for the tail light and amber for the stop light.



A13450 Sept. '29 - till end '31 Price Ea. \$ 6.00

Tail Light Stop Lens

This is a glass red lens with the letters "STOP" molded in amber.



A13450S 29-31 Price Ea. \$ 8.95

Tail Light Blue Dot Lens

This is the all-red lens with the blue dot already installed in the stop section.



A13450BD 29-31
Price Ea. \$ 13.75

Tail Light Blue Dot

For the DIYer, you can fit your own blue dot in with this. It has a chrome rim. 1 Piece Set. Need 1 Set for one lens.



A13450D 28-31 Price Set \$ 4.95

Tail Light Snap Ring

This was used to hold the lens in the tail light rim. The sequence was the rim gasket, then the lens, then the snap ring.



A13456 29-31
Price Ea. \$ 0.95

Tail Light Gasket

This goes between the face of the lens and the rim but many put one on both sides of the lens to reduce the risk of cracking.



A13461 29-31
Price Ea. \$ 0.50

License Plate Lens

This is the clear lens for the left side tail light to illuminate the license plate.



A13445 29-32
Price Ea. \$ 3.45

License Lens Gasket

This is the gasket for the clear license lens.



A13447 29-32 Price Ea. \$ 0.50

License Lens Retainer Clips

Two retainers and screws to hold the license lens in the tail light.



A13446S 28-32 4 piece set
Price Set/4 \$ 1.50

PICKUP

Mike's "A" FORD-ABLE Parts

Tail Light Loom

This is what Ford used to protect the tail light wires from the elements. Extends from tail light through fender to under body.



A13412L 28-31 Price Ea. \$ 1.25

Tail Light Wire Clip

This clip holds the tail light loom to the fender.

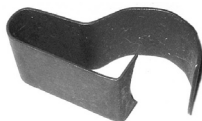

A14565 28-31 Price Ea. \$ 2.65

Tail Light Wire Clip

This clip holds the wire to the bottom side of the wood subrail. Includes one clip and wood screw. 1928 - 1931 Station Wagons.



A14592 28-32 Price Set \$ 2.00

Tail Light Socket

Press this socket into the tail light bucket to hold the bulb.

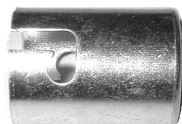

A13412S 29-31 Price Ea. \$ 0.65

Double Contact Socket

These universal style sockets are used to convert any lamp to a dual filament bulb that can be used for turn signals. Use staggered pin bulbs. Some modification to your lamp will be needed to accept these.



A13412DC 28-31 Price Ea. \$ 8.10

Tail Light Wire Pigtails

This pigtail with springs and washers extends out the back of the tail light to make your connection. Correct fabric and colors. Black for Taillight / Green for Stop Light.



A13412/13 29-48 Price Pair \$ 3.60

Tail Light Cross Over Wire

This cross-over wire allows you to add a right tail light and then connect the two tail lights to the main harness.



A14423XO 28-31 Price Set \$ 9.00

Tail Light Reinforcing Plate

Lessen the risk of damaging your fender by using this plate under the fender to attach your tail light bracket. This plate is only used if you attach your tail lights to your fenders, which was not original on Pickups.



A13463 29-31 Price Ea. \$ 3.25

Tail Light Bracket Pad

Protect your fender from metal to metal vibration with this rubber pad which fits between the fender and the tail light bracket. This pad is only used if you are using the Reinforcing plate A13463.



A13520 29-31 Price Ea. \$ 2.00

Tail Light Bracket

These brackets are ready to mount. Same gauge steel Ford used. Used with teacup style tail lights. Not originally used on Pickups or Station Wagons - but this is your choice.



A13471R	29-31	Right	Price Ea.	\$ 9.85
A13471L	29-31	Left	Price Ea.	\$ 9.85
A13471RC	29-31	Right - Chrome	Price Ea.	\$ 13.95
A13471LC	29-31	Left - Chrome	Price Ea.	\$ 13.95

Tail Light Bracket Bolts

This set of 3 special carriage bolts and nuts is used to bolt the tail light bracket to the fender. Bolts have large heads. 3 X 1/4-20 5/8 Bolt with Large Head. You will only need these bolts if you are mounting your tail lights to the fenders which was not original.



A13474BK	29-31	Price Set/6	\$ 1.75
A13474SS	29-31	Stainless steel	
		Price Set/9	\$ 3.25

PICKUP

Mike's "A" FORD-ABLE Parts

Commercial Tail Light Bracket

This is a special cast iron bracket used for the tail light on the following vehicles:

'29-'31 Station Wagon, '30-'31 Panel Delivery, Deluxe Delivery and Deluxe Pick-Up and Special Delivery.



A13472B 29-31

Price Ea. \$ 9.50

Commercial Tail Light Bracket Screws

These are the stainless screws and lock washers you'll need to attach the commercial tail light to the bracket.



A13472BR 29-31 2 x 1/4" - 28 x 3/4" & L.w.

Price Set/4 \$ 0.95

Pickup Tail Light Shield

This shield protects your wires from the elements and accidental damage where they come out from the tail lights on commercial vehicles.



A13467 29-34

Price Ea. \$ 6.25

Pickup Tail Light Bracket

This is a nice cast iron bracket that is used on both the Pickup Truck, Station Wagon and AA Trucks.



Used on teacup lights from March '29 till May '30 on Pickups - March '29 till End '31 on AA Pickups.

A13470 29-37

Price Ea. \$ 9.95

Pickup Tail Light Mounting Block

This is the wooden block needed to mount the tail light bracket on the Pickup.

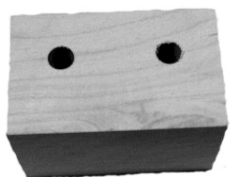

A13471W 29-31

Price Ea. \$ 2.95

Pickup Tail Light Bracket Block Bolts

Two 1/4 x 3 Carriage Bolts, lock washers and nuts to mount the Pickup Tail Light Bracket block.

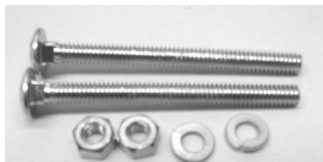

A13470X 29-31

Price Set/6 \$ 0.95

Rear License Bracket

An identical reproduction of the original.



A13406D 28-31

Price Ea. \$ 6.50

A13406SS 29-31 Polished Stainless Steel

Price Ea. \$ 15.95

Rear License Plate Special Bolts

The nuts and bolts necessary to mount your license plate.



A13407MB 28-31

Price Set/4 \$ 4.35

License Plate Reflector Bolts

A reproduction of an aftermarket accessory. These bolts are sold in pairs and available in four different colors.



A13408

Blue

A13409

Amber

A13410

Green

A13411

Red

Price Pair \$ 1.00

Stop Light Switch

The early A's used this type switch which mounted on the transmission. Don't forget to order your link A13507R. Best Quality.



A13480A 28-30

Price Ea. \$ 5.95

Stop Light Switch Link

This is the metal link for the A13480A stop light switch.



A13507R 28-29

Price Ea. \$ 1.45

Stop Light Switch

A few '29's had this but mostly for '30-'31's. This bolts to the cross member of the frame. Needs A2465B (Page Gen. 50) Pedal to Brake shaft rod.

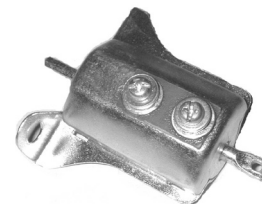

Best Quality.

A13480B 30-31

Price Ea. \$ 5.00

PICKUP

Mike's "A" FORD-ABLE Parts

Stop Light Switch Mounting Bolts

Here are the bolts, nuts, and lock washers to mount the '30-'31 style stop light switch to the cross member.

2 - 1/4-20 x 1/2" Bolts, lockwashers and nuts.



A13480MB 30-31 Price Set/6 \$ 0.55

1928 / 1929 Stoplight Switch Mounting

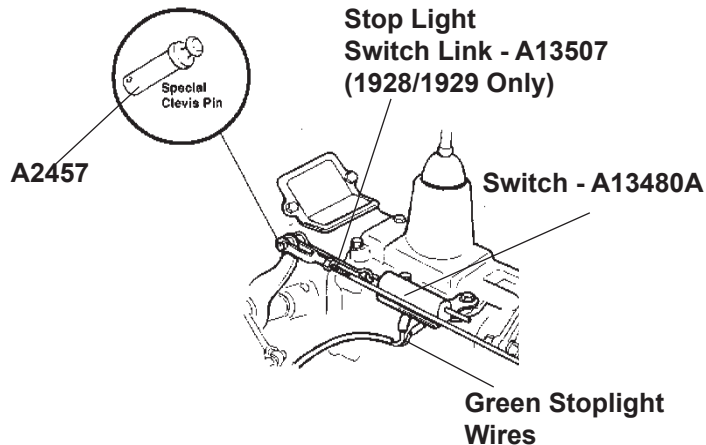

1930 / 1931 Stoplight Switch Mounting

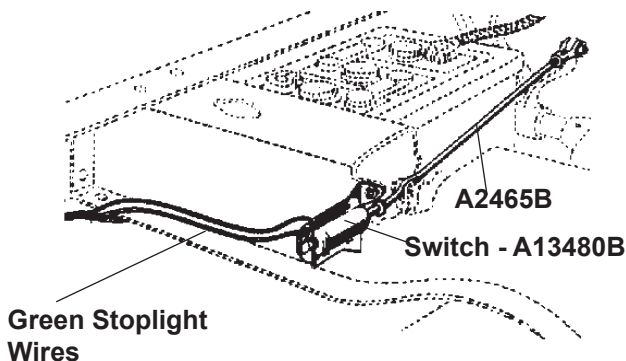

Thanks to Les Andrews for the use of his drawings.

See Page P/UP 72 for the complete Turn Signal Section.

As in many areas of Commercial Vehicles, so many of the facts are clouded and information is limited - particularly this Australian Version. The 1931 UTES (Utility Vehicles) were built at the Ford Plant in Geelong, Australia. Complete chassis were imported from Canada obviously RHD, Hoods, Radiators, Grill and Headlights were installed at the Geelong Plant and then sent to Ford Authorized body builders in each state. The manufacturing of these beds was conducted under the close supervision of Ford Engineers. Pictures confirm that the 1929 model called a "Sample Truck No. 301" did have the chrome bars on the top edge of the bed, yet the '30 and '31 models did not. The bars were also on the Hard Top 66A Deluxe Pick-Up.

Custom LED Third Brake Lights

Made in USA. Custom LED Third Brake Light fits in the back window of cars and trucks. Strong, twin suction cups attach the rugged, black ABS case to the glass in the back window. Two wire, easy hookup works with 6V or 12V negative or positive ground vehicles.



Electronics feature all solid state components (nothing to wear out and the LEDs should last for over 25 years!). No permanent modifications to your car are required. Kit comes with Third Brake Light, harness, connectors, mounts, and suction cups. Logo Lites Custom LED Third Brake Lights are backed by a one year manufacturer's warranty.

A13312S	STOP	Price Kit	\$ 72.00
A13312A	1928	Price Kit	\$ 72.00
A13312B	1929	Price Kit	\$ 72.00
A13312C	1930	Price Kit	\$ 72.00
A13312D	1931	Price Kit	\$ 72.00

A custom Third Brake Light is available. Any 4 Characters of your choice is available, eg MIKE

A13312O	Special 4	Price Kit	\$ 99.65
---------	-----------	-----------	----------



This truck is a Type 301 - Ford Commercial - Australian UTE - Once owned by Mike.



PICKUP

Give us a call - 1-888-TRY-MIKE (879-6453)

Have an "A" Day! P/UP-69

DRUM TAIL LIGHT

Stop Light Bulb

21 Candle Power.



A13465 28-31 Price Ea. \$ 1.00

Tail Light, Parking Light, Cowl, Instrument Panel & Dome Light Bulb

3 Candle Power as original.

10 Candle Power is available if you would prefer a brighter bulb.



A13466/3 3 CP Price Ea. \$ 0.90
A13466/10 10 CP Price Ea. \$ 1.25

Complete Drum Tail Light

Top quality reproduction with the black bracket and nickel body. Used on '28's and early '29's. All black - used on commercial Vehicles.



A13405DCL - Commercial - Left - Black Ea. \$ 99.50
A13405DCR - Commercial - Right - Black Ea. \$ 99.50

1) Assemble contact-insulating washers and rivets. Seat down & upset rivet so that contact can be rotated.

2) Assemble divider plate using 3/16" rivets.

3) To install backing plug; tap into hole from front with slot turned clockwise until slot is level with plate.

Rotate contact and plug so contact

enters small slot in brass plunger. When aligned tap in until locking plunger enters hole in rear of plate.

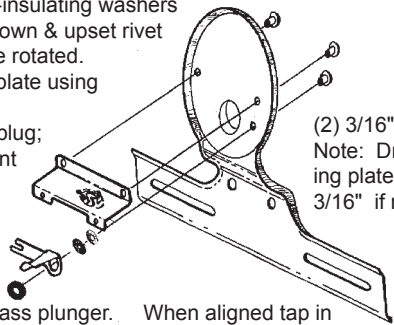

(2) 3/16" Rivets
Note: Drill backing plate 3/16" if required.

Drum Tail Light and License Bracket to Support Bracket Bolts



Two 5/16-24 x 11/16 Hex Bolts, L/w's and Nuts.
A13607 28 - Early '29 Price Set \$ 0.50

Drum Tail Light Support Bracket to Body Bolts



Two 5/16-24 x 5/8 Hex Bolts and L/w's.
A13673 28 - Early '29 Price Set \$ 0.50

Commercial Drum Tail Light Bracket

Used on drum tail lights. These were used from 1928-July 1929

on Pickups, AA Trucks & Panel Deliveries.

Fits Left or Right.



A13470A 28-29 Price Ea. \$ 16.95

Drum Tail Lamp Socket

This is the bulb socket for the '28-'29 drum tail light.

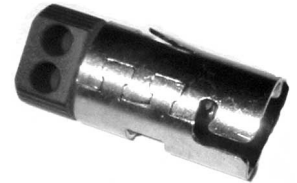

A13410A 28-29 Price Ea. \$ 34.98

Drum Tail Light Divider Plate

This divider plate separates the tail lamp from the stop lamp sections on the drum style tail light.

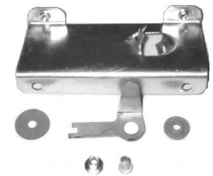

A13406DP 1928 - Early 1929 Price Set \$ 21.75

Drum Tail Light Body

This is a very good nickel-plated reproduction. Body only.



A13440DBCL - Commercial - Left - Black
A13440DBCR - Commercial - Right - Black
1928 - Early '29 Price Ea. \$ 31.00

Drum Retainer Screws

This is the special hardware necessary to hold the tail light body and lens on.



A13441BT 28-29 Price Set/6 \$ 5.75

PICKUP

Mike's "A" FORD-ABLE Parts

Drum Stop Face Plate

This steel insert with the word "STOP" fits behind the red lens.



A13442AR 1928 - Early '29 Price Ea. \$ 6.30

Drum White License Lens

For the '28 drum tail light only.

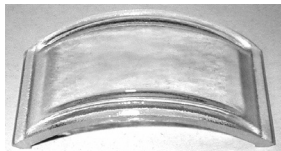

A13445AR 1928 - Early '29 Price Ea. \$ 10.00

Drum Retainer Clips

Two retainers and screws to hold the license lens in the drum tail light.

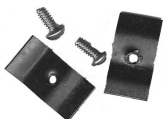

A13446S 28-31 4 piece set Price Set/4 \$ 1.50

Drum License Lens Gasket

This is the gasket for the '28 license lens on the drum tail light.



A13447AR 1928 - Early '29 Price Ea. \$ 0.75

Drum Red Lens

This is an all-red lens for the '28 drum tail light.



A13450AR 28-29 Price Ea. \$ 7.60

Drum Tail Light Lens Gasket

This is the round gasket for the drum tail light.



A13461AR 1928 - Early '29 Price Ea. \$ 0.60

Drum Tail Light Wire Clip

You'll need two of these to hold the wire to the tail lamp bracket on the '28 drum tail light.



A14595 1928 - Early '29 Price Pair \$ 2.95

Drum Tail Light Extension Wire

This wire goes from the drum tail light to the main wiring harness.



A14423AR 28-29 Price Ea. \$ 5.65



1930 Yukon Yellow Closed Cab Pickup

PICKUP

TURN SIGNALS

Turn Signal Kit (6 Volt)

BE SAFE. Signal Stat. Add this complete turn signal kit directly to your tail lights. Kit includes the switch, fuse, flasher, flasher socket and complete instructions. Cowl conversion kit works with this one. If you do not have cowl lights you will need to install front turn signal lights of some sort. Comes with instructions. 11 Piece Set.



A13310A **28-31** **Price Set/11 \$ 58.95**

Turn Signal Flasher

6-Volt flashers are hard to find; you'll need this if you have added turn signals to your A.



A13311 **28-31** **Price Ea. \$ 5.25**

Turn Signal Lamps

If you are using the **A13310A** Turn Signal Kit these are the turn signal lights that will fit between the bumper bars on the front and rear. No modifications needed. Don't forget to buy extra wire by the foot see wiring section - **Page Gen. 93**. Available for both 6 & 12 Volts. Use on front and rear.



A13405T6	6 Volt - Amber	Price Ea.	\$ 20.95
A13405T6R	6 Volt - Red	Price Ea.	\$ 20.95
A13405T12	12Volt - Amber	Price Ea.	\$ 19.95
A13405T12R	12 Volt - Red	Price Ea.	\$ 19.95

LED Replacement Tail Light - All Red & Half Amber

Use this brand new product in your duo lamp housing and have the advantage of LED Tail lights. 6 or 12 Volt.

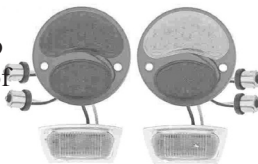

12 Volt			
A13453	Right - Half Amber		
A13453R	Right - Red		
A13454	Left - Half Amber		
A13454R	Left - Red	Price Ea.	\$ 40.00
6 Volt			
A13455	Right - Half Amber		
A13455R	Right - Red		
A13457	Left - Half Amber		
A13457R	Left - Red	Price Ea.	\$ 43.00

Complete Turn Signal Kit (6 or 12 Volt + or -)

Now you can have super bright Amber LED turn signals for your "A"! Kit includes super bright LED turn signals, stainless steel brackets, controller and wire. The easy hookup connects to 6 Volt OR 12 Volt cars with negative or positive ground without even flipping a switch. The kit features all solid state components (there are no turn signal flashers to wear out and the LED's will last for over 25 years!). The whole kit is bolted on so you don't have to permanently modify your car. Slim line turn signals mount to bumper clamp bolts and have a one wire hook up. Each turn signal is individually short circuit protected so if one wire shorts to the chassis, only that one light won't come on. Eliminate the short and the turn signal will work again. Also has a hazard light function and is backed by a one year manufacturer's warranty. 20 Piece Set.

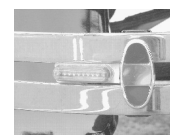
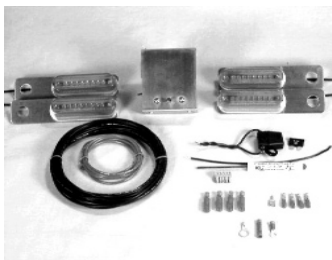

A13311A **28-31** **Price Kit/20 \$ 169.95**



PICKUP

DASH & DOME LIGHT

Specifications:

Instrument Panel:	3 CP, single contact, Mazda 63
Dome:	3 CP, single contact, Mazda 63
Commercial Dome:	15 CP, single contact, Mazda 87

Dash Light

This mounts in the middle of the dash on the '28-'30 A's with the oval speedometer. Attach the dash wire to the charge post on the amp meter.



A13708AR 1928 - June 1930 Price Ea. \$ 22.55

Dash, Dome, Cowl & Parking Light Bulb

3 Candle Power as original.
10 Candle Power is available if you would prefer a brighter bulb.
See Page P/UP 65 for Quartz Bulbs.



A13466/3	3 CP	Price Ea.	\$ 0.90
A13466/10	10 CP	Price Ea.	\$ 1.25

Dash Light Cover

This is the cover only for the dash light on the '28-'30 oval speedometer. Only fits repro Dash light.



A13705 28-30 Price Ea. \$ 13.70

Dash Light Bracket

If your dash light mounts up under the dash, you'll need one of these brackets.



A13706BRC	30-31	Closed car.	Price Ea.	\$ 1.95
A13706BRO	30-31	Open car.	Price Ea.	\$ 1.55

Dash Lamp Cap Only

For Open and Closed Cars.
Switch Type.

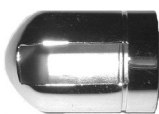

A13705B 30-31 Price Ea. \$ 13.50

Dash Light (Excellent Replacement)

This is the dash lights for the '30-'31 A's with the round speedometer; this mounts under the dash rail.

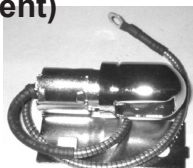

See A13710 for dash light armored cable.

A13708B	June '30 - till end '31	Closed Car	Price Ea.	\$ 24.15
A13708C	June '30 - till end '31	Open Car		

Dash Light Armored Cable

This 1/8" diameter single strand cable is used for the dash light but can also be used for a sport light. Cut and sold in 12" lengths.

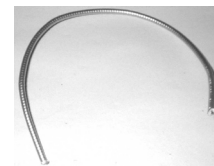

A13710 28-31 Price Ft. \$ 1.65

Dome Light Assembly (Without Switch)

Same unit as A13771WS except this has no switch. You will have to purchase A13770 Cover and A13769 Switch and A13778 Wire.



A13771 30-31 Price Ea. \$ 45.65

Dome Light Snap Ring

This little cadmium plated ring can be hard to find but you'll need it to hold the lens onto the dome light.

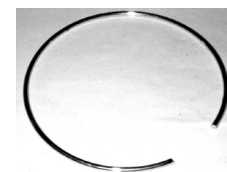

A13771C 30-31 Price Ea. \$ 5.50

Dome Light Lens

Milky-colored replacement lens for the round dome light. Fits A13771WS.

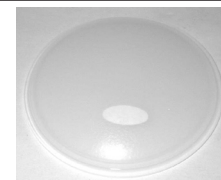

A13771G 30-31 Price Ea. \$ 8.50

Dome Light Wire

This is the correct 16 gauge cloth covered wire; black with a blue tracer. Order per foot needed for your vehicle. Wire starts at the drivers side of the terminal box, up the windshield post, half way across the header and back to the dome light. Make sure you run a ground wire from the light to the side of the body.



A13778 Price Ft. \$ 0.65

Wiper and Dome Lamp Wire Support

This clip was held in place by a bolt that held the gas tank to the cowl. It served as a grommet holder for the wiper and or dome lamp wire, and the other part of the clip held the top of the kick panel in place. Grommet included. 2 Required.



A14591	28-29	Price Ea.	\$ 4.30
A14591GR	Grommet Only	Price Ea.	\$ 0.70

Mike's "A" FORD-ABLE Parts

Dome Light Switch and Cover

This replacement switch with cover mounts on the door pillar.



A13770 28-31 Cover Price Ea. \$ 2.75

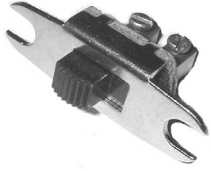

A13769 28-31 Switch Price Ea. \$ 8.75

See Page P/UP 13 for Dome Light Wood.
See Page Gen. 198 for Wire - Sold by the Foot.
See Page Gen. 189 for Ignition Switch & Parts.



A Pair of Panels:
1929 79A & 1930 79B.

GARNISH MOLDINGS AND FRAMES

Steel Garnish Molding

These steel reproduction garnishes are really good quality.



A842A	28-29	Closed Cab Pickup - 27 3/8"	Price Pair	\$ 80.00
A442B	30-31	Closed Cab Pickup - 27 7/16"	Price Pair	\$ 80.00

Garnish Molding Screws

These screws are 10/32 x 1/2 to attach the garnish molding to the door.



A342S 28-31 Price Ea. \$ 0.15

Closed Cab Pickup Window Frames

Mike also has these upper window frames for the '28-'29 Closed Cab Pickup. RAR227 & RAR228 are included.



A80301L	28-29	Left	Price Ea.	\$ 60.00
A80301R	28-29	Right	Price Ea.	\$ 60.00

Closed Cab Pickup Window Frame Brackets

Screw these metal strips onto the vertical portion of the window opening for the window frames to slide down on. These are included with the new frames A80301L or R.



For the '28-'29 Closed Cap Pickup and Panel Trucks.

RAR227	28-29	Front of Door	Price Ea.	\$ 11.00
RAR228	28-29	Rear of Door	Price Ea.	\$ 11.00

Closed Cab Pickup Inside Rear Window Frame(Steel)

This is a good Steel reproduction of the rear window frame, complete with hardware, for the Closed Cab Pickup. Stamped steel.



A37639APU	28 - Mid 30	Price Set	\$ 37.00
A65105B	30-34	Price Ea.	\$ 82.00

PICKUP

Mike's "A" FORD-ABLE Parts

Pickup Rear Window Frame Screws

This set of screws only is what you need to mount the rear window frame on the **Closed Cab Pickup**.

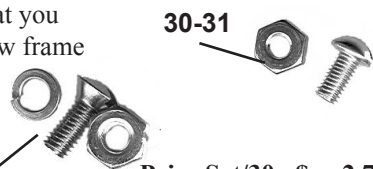

A37639AMB	28-29	Price Set/30	\$ 2.75
A37639BMB	30-31	Price Set/44	\$ 2.75

Closed Cab Pickup Rear Window Reinforcement Braces

The Steel 'L' Brace at each corner of the **Mid '30-'31 Closed Cab Pickup** rear window. 4 Needed per Pickup.



RAR208	Mid ' 30 - 31	Price Each	\$ 6.75
--------	---------------	------------	---------

Roadster Pickup Upholstery Channels

These channels go on the rear quarter panels to hold the upholstery panel on the **'28-'29 Roadster Pickup**.



A1052	28-29	Price Pair	\$ 40.00
-------	-------	------------	----------

Pickup Door Lever Anti-Rattler

This style was used on some of the Model A trucks with the slide door opener. This is a carry over from Model "T".



A8320B	28-29	Price Pair	\$ 3.95
--------	-------	------------	---------

Rear Window Frame

Steel window frames, exact copy of Fords from the Ford Blue Prints are now available for the following vehicles:
'28-'30 Deluxe Delivery 130A



A47096A	28-31	Price Ea.	\$ 79.50
---------	-------	-----------	----------

Rear Window Screws

Hold your window frame in place with this Set of Twelve **#10 x 1** Oval Chrome Plated Wood Screws.



A48251	28-31	Price Set	\$ 1.20
--------	-------	-----------	---------

Delivery Window Retainers

These metal strips hold the glass in the back doors of the **1929 Double Door delivery 79A**.
4 Pieces for one window.



RAR202	1929	Price Set/4	\$ 37.95
--------	------	-------------	----------

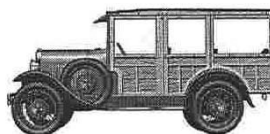
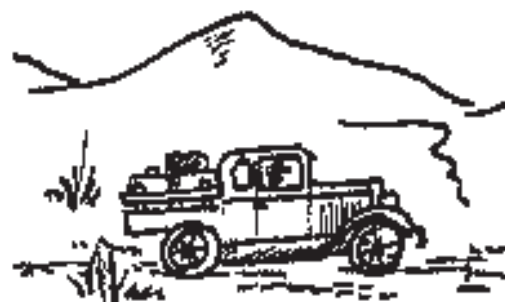

1928-29 STATION WAGON (150-A)



1930-31 STATION WAGON (150-B)

PICKUP

SILL PLATES

1928-29 Roadster Pickup Sill Plates

This is an excellent reproduction of the sill plate used on the '28-'29 Roadster Pickup.



A1033P 28-29 Roadster Pickup
 Price Pair \$ 130.00

Roadster Pickup Sill Plate Brackets

This bracket goes between the subrail and the sill plate frame at the door on:

1928 - 29 Roadster Pickup.



A1034 28-29
 Price Pair \$ 36.00

Roadster Pickup Sill Plate Screws

The correct screws for the Open Car Sill Plates. **Eight #10 x 3/4** Oval head sheet metal screws.



A48653 28-31 Price Set/8 \$ 1.00

Grandfathers Day - why not bring your A??
Always the first Saturday in June.



SEAT PARTS

Closed Cab Pickup Seat Back Retainer Clip

This set of clips will hold the back of the seat to the Pickup Cab. The upper clip mounts to the face of the belt rail wood. Used on Mid '30 - 1931 CC Pickups.

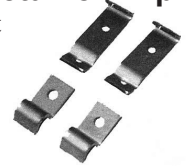

RAR233 30-31 Price Set/4 \$ 16.25

Closed Cab Pickup Seat Back Retainer Clip

Use this set of clips to hold the back of the seat to the Pickup Cab. The 4 top clips were spot welded to the back of the cab under the belt rail wood.

Used on **Late 1931 CC Pickups.**

RAR234 Late 1931 Price Set/6 \$ 17.00

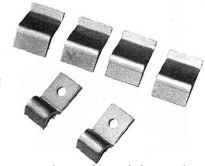

Closed Cab Pickup Seat Back Retainer Clip

This is the rear seat retainer which was used on the '28-'29 Closed Cab Pickups.



RAR239 28 - Mid 30 Price Set/4 \$ 6.25

Closed Cab Pickup Seat Back Retainer Clip Nut

These special nuts are used to hold the RAR239 in place on the '28-'29 Closed Cab Pickup. 2 Needed.



RAR240 28-29 Price Ea. \$ 3.55

Pickup Seat Backrest Hook

You will need two of these hooks to hold the bottom of the seat back to the wooden frame. Need 2.



A80300 28-34 Price Ea. \$ 5.00

Roadster Pickup Seat Stiffener

This set which is located on the back of the seat frame. Used on '28-'29 Roadster Pickups.



A121ABRACE 28-29 Price Ea. \$ 51.00

SEAT SPRINGS

Note: All seat springs are shipped directly from the manufacturer. We do not stock springs. Please make sure you know exactly what year and Model you have as the manufacturer will not take springs back. Oversize shipping charges do apply. 1928 - 1929 has rounded edges and the 1930 - 1931 has squared edges with smaller springs.

28-29 Closed Cab & Roadster Pickup

S800	Cushion	\$ 70.50
S801	Backrest	\$ 69.25

30-31 Closed Cab & Roadster Pickup

S802	Cushion	\$ 70.50
S803	Backrest	\$ 69.25

1931 Closed Cab Pickup - Indented Firewall

S804	Cushion	\$ 70.50
S805	Backrest	\$ 69.25

1931 Roadster Pickup - Indented Firewall

S802	Cushion	\$ 70.50
S803R	Backrest	\$ 71.75

Station Wagon - 28-31

S950	Front Cushion	\$ 69.50
S951	Front Backrest	\$ 68.00
S952	Jump Cushion - Middle	\$ 45.25
S953	Jump Backrest - Middle	\$ 42.75
S954	Rear Cushion	\$ 69.50
S955	Rear Backrest	\$ 67.75

UPHOLSTERY

DUE TO THE ENORMOUS SELECTION OF UPHOLSTERY CHOICES FOR THE MODEL A'S - WE HAVE LEFT THE UPHOLSTERY SECTION TOGETHER.

SEE PAGE Gen. 224 FOR ROADSTER AND CLOSED CAB PICKUP INTERIOR KITS.

SEE PAGE Gen. 225 FOR ROADSTER AND CLOSED CAB PICKUP COWL AND DOOR PANEL SETS

SEE PAGE Gen. 230 FOR ROADSTER PICKUP TOPS AND PADS

SEE PAGE Gen. 226 FOR CLOSED CAB TOP KITS

SEE PAGE Gen. 227 FOR ROADSTER PICKUP SIDE CURTAINS

Another view of Mr. Brademeyer's incredible collection.



PICKUP

Mike's "A" FORD-ABLE Parts

Notes

Notes

PICKUP

