

All Sedans

- 1928 - 1929 Tudor Sedan 55A
- 1930 - March 1931 Tudor Sedan 55B (Std)
- March 1931 Deluxe Tudor Sedan 55C
- May 1928-1929 Fordor Sedan - 2 Window - (leather back - seal brown top - Briggs) 60A
- 1929 Fordor Sedan - 2 Window - (leather back - black top - Briggs) 60B
- 1929 Fordor Sedan - (steel back - Briggs) 60C
- 1929 - April 1930 Fordor Sedan - Std. - 2 Window 170A
- April 1930 - 1931 Fordor Sedan - Dlx - 2 Window 170B
- March 1931 Fordor Sedan - Deluxe 2 Window - Slant Windshield 160C
- 1929 Fordor Sedan - Std. - 3 Window - Murray 165A
- 1929 Fordor Sedan - Std. - 3 Window - Briggs 165B
- 1930 - March 1931 Fordor Sedan - Std. - 3 Window - Murray 165C
- 1930 - March 1931 Fordor Sedan - Std. - 3 Window - Briggs 165D
- March 1931 Fordor Sedan - Standard - 3 Window - Slant Windshield 160A
- 1929 Town Sedan - 3 Window - Murray 155A
- 1929 Town Sedan - 3 Window - Briggs 155B
- 1930 - March 1931 Town Sedan - 3 Window - Murray 155C
- 1930 - March 1931 Town Sedan - 3 Window - Briggs 155D
- March 1931 Town Sedan - 3 Window - Slant Windshield - 160B

SEDAN

Index	Page #
Books & Accessories	Sedan 2
Cowl Lights	Sedan 61
Dash & Dome Light	Sedan 73
Door Handles & Parts	Sedan 34
Drum Tail Light	Sedan 70
Fenders & Brackets	Sedan 14
Floorboards	Sedan 47
Garnish Moldings & Frames	Sedan 75
Gas Gauge	Sedan 53
Gas Tank	Sedan 48
Glass Sets & Pieces	Sedan 25
Hood	Sedan 16
Insulation Kits	Sedan 46
Mirror	Sedan 59
Seat Parts	Sedan 78
Seat Springs	Sedan 81

Index	Page #
Sheet Metal	Sedan 4
Sill Plates	Sedan 76
Spare Tire	Sedan 14
Speedometer	Sedan 55
Spring (Rear)	Sedan 21
Sun Visors & Panels	Sedan 9
Tail Lights	Sedan 65
Top Parts	Sedan 30
Turn Signals	Sedan 72
Upholstery	Sedan 81
Window Shades & Brackets	Sedan 33
Windshields and Parts	Sedan 22
Windshield Wipers	Sedan 26
Wood	Sedan 10

Mike's "A" FORD-ABLE Parts

Books & Accessories

New Ford Poster

Chances are, that you would have found this poster hanging on the wall of your local Model A Dealer's showroom. Describes the special features of the Model A Ford. This is a 17" x 36" color poster.

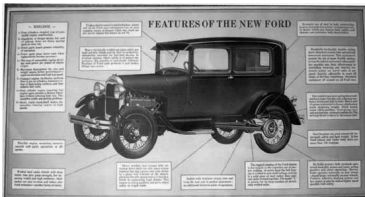

A91070 28-31 Price Ea. \$ 10.00

Ford Color Prints - 12" x 18"

Beautiful prints of Made in America cars. Full color prints are from original paintings by Ford Motor Company illustrator Don Pacitti. You can order these prints with or without the Wood Grain finished frame with gold highlights. You can order these prints with or without the Wood Grain finished frame with gold highlights.

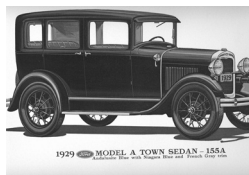

Prints ONLY - 11" x 14"

A91360 1929 Fordor Briggs Sedan - 60A
Price Ea. \$ 3.00

Prints ONLY - 12" x 18"

A91155 1929 Town Sedan - 155A
Price Ea. \$ 4.00

Framed Print - 11" x 14"

A91360F 1929 Fordor Briggs Sedan - 60A
Price Ea. \$ 18.00

Framed Print - 12" x 18"

A91155F 1929 Town Sedan - 155A
Price Ea. \$ 18.00

See Vol. 5 - How to Restore your Model for some excellent restoration information. See Page 101 for Std. '30-'31 Tudor & Page 117 for 1931 Deluxe Tudor.

Windwing Glass

This glass is cut to the original specs and is beveled.

Sold in pairs only.

The design is etched onto the glass with silk screen fired ceramic.



A68980	28-29	Tudor - 16" Tall	Price Pair	\$ 41.95
A68980D	28-29	Etched	Price Pair	\$ 59.00
A61951	30-31	Tudor - 15 3/8" Tall	Price Pair	\$ 39.95
A61951D	30-31	Etched	Price Pair	\$ 54.00
A79988	1931	S/W Fordor - 15" Tall	Price Pair	\$ 36.00

Windwing Clamps

These clamps are chrome plated for the windwing glass.



A18200C 28-31 Price Set/8 \$ 75.00

Car Covers

For indoor storage only. Poly cotton material.



C115PD Sedan Price Ea. \$ 149.95

Sedan Key Fob

A wonderful gift idea. A silver plated brass key fob with a swivel feature that keeps the image always in view.



A18915	3 Window Fordor	Price Ea.	\$ 19.95
A18925	Tudor Sedan	Price Ea.	\$ 19.95

Mike's "A" FORD-ABLE Parts

Wallpaper Border

A wonderful finishing touch for your office or shop. Pre-pasted vinyl wall paper strips. 15' X 7".



A18825 Passenger Border Price Roll \$ 10.50

Data Plate Rivets

This pack of 12 rivets will attach your data plate on the A.



#100 28-31 Price Set/12 \$ 1.50

Data Plates

The Fordor Sedans used either the Murray or the Briggs data plate on the outside of the firewall on the passenger side.



A18651 28-31 Briggs Price Ea. \$ 1.50



A18652 28-31 Murray Price Ea. \$ 1.50

Trunks

This is a good quality, felt lined, trunk with all the hardware and leather straps. A locking key included. 13 x 34 x 20" High.



Tapered Backs are for Sedans with a side mounted spare.

A18574SB 28-31 Black Price Ea. \$ 350.00
A18574ST 28-31 Tan Price Ea. \$ 350.00

PLEASE NOTE: DUE TO THE SIZE AND WEIGHT OF THE TRUNKS THERE WILL BE AN ADDITIONAL SHIPPING CHARGE. PLEASE CALL FOR CURRENT PRICES.

See Page Gen. 17 for Luggage Racks.

Trunk Straps

For mounting your trunk to the rack. 1" Wide by 72" Long. Nickel Plated Hardware. These are included with a new trunk. Need 2 per Trunk



A18574B 28-31 Black Price Ea. \$ 23.75

A18574T 28-31 Tan Price Ea. \$ 23.75

Trunk Boots

These will protect your trunk from the elements. It slips over the trunk and fastens with velcro. For trunks 12 3/4 d, 34 1/4 w, and 20"h.



A18575BCB 28-31 Curved Back Sedan - Black Price Ea. \$ 79.95

Sedan Luggage Rack Adapter Bracket

These are the adapter brackets for the Tudor and Fordor Sedans with rear mount spare.



RAR268 28- Early 31 Price Set \$ 69.95

Tudor Basement

For the 1928 - 1931 Tudor Only. 2,520 cubic inches of under the floor concealed storage space for spare parts or hiding valuables, completely concealed. Painted black.

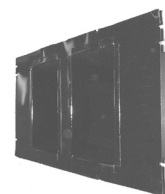

A801 28-31 Price Ea. \$ 115.00

Mike's "A" FORD-ABLE Parts

Sheet Metal

Spare Tire Brace

This brace supports the inside of the outer panel for the spare tire bracket. Can be used on '28-'29 panels, but must be shortened to fit.



A163ABR 28-31 Price Ea. \$ 21.00

Rear Seat Frame

Seat spring sits on this part. Includes hump. Spot weld to rear floor.



A457A1WH 28-29 Tudor Sedan Price Ea. \$ 225.00

A457BWH 30-31 Tudor Sedan Price Ea. \$ 225.00

With floor pan, spot weld to rear floor - No Hump.



A457A1 28-29 Tudor Sedan Price Ea. \$ 187.50

A457B 30-31 Tudor Sedan Price Ea. \$ 187.50

Rear Floor Pan Spring Hump

Hump - 8 1/2" x 22".

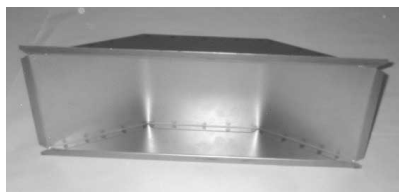

A458AB 28-31 Tudor & Fordor Price Ea. \$ 37.50

Body Channels

Your Floorpans attach to these. 48 1/2" Long. Measurements are approximate.



A131 28-31 All Body Styles
1 x 3" x 3/4" Lips
2 x 2" x 3/4" Lips
Price Set \$ 65.00

Panel Under Seat Frame

This goes under the Seat Riser and serves as a Floor Pan.



A316AH 28-29 Fordor - Front Price Ea. \$ 49.00

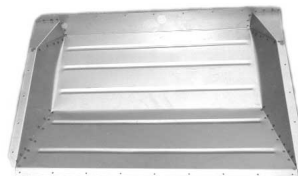

A337A 28-29 Murray Fordor - Rear Price Ea. \$ 92.00

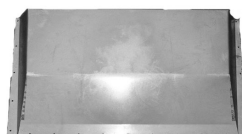

A337B 28-29 Briggs Fordor - Rear Price Ea. \$ 92.00

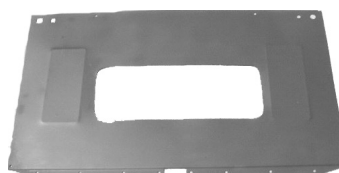

A375A 28-31 Tudor Sedan - Does not include Hump Price Ea. \$ 52.00



27 1/2" Long x 11 1/2" Wide x 2 1/2" Deep
A68C 1931 Late 1931 Slant Windshield Fordors Price Ea. \$ 74.70

Lower Cowl Patch

This special Cowl Patch will only work on the 1928 - 1929 Briggs Two Window Fordor Sedan, 1928 - 1929 Murray Three Window Fordor Sedan.



A014-4DC 28-29 Price Pair \$ 32.95

Mike's "A" FORD-ABLE Parts

Cowl Quarter Patch Panels

All body styles except Fordor,
Briggs & Murray Sedans



A114A 28-29 Complete panel
Price Pair \$ 114.00



AM724 28-29 Bottom 6" Panel
Price Pair \$ 43.00



13 1/2" x 6" High

A114B 30-31 All body styles
Price Pair \$ 26.95

Contoured Cowl Patch

A new correctly contoured patch has the
compound curves of the cowl and also
the correct beading. Available only
for '30-'31.



A014BD 30-31 Price Pair \$ 53.50

Door Bottom Outer Patch Panels

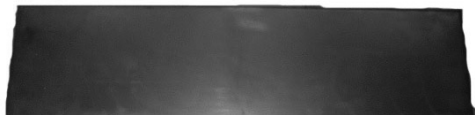

A436A 28-29 Sedan Price Pair \$ 49.95



A436B 30-31 Tudor Sedan
Price Pair \$ 55.00

Murray Body has a bead at the bottom - Briggs Body is smooth
- Please specify if Murray or Briggs 6" High, 13 1/4" tapering
to 11" 3/4" at lowest point



4 Pieces

A825 30-31 Fordor Sedan - Murray
Price Set \$ 59.95

A825A 30-31 Fordor Sedan - Briggs
Price Set \$ 59.95

Door Bottom Inner Patch Panels



A336A1 28-29 Tudor - 25 3/8" x 4 3/4"
Price Pair \$ 43.50



A436B1 30-31 Tudor - 25" x 4 3/4"
Price Set \$ 45.00

Rear Quarter Patch Panels



A450A 28-29 Tudor Sedan
Price Pair \$ 46.00



A450B 30-31 Tudor Sedan - Beaded Edge -
14" x 6 1/2"
Price Pair \$ 46.00

SEDAN

Mike's "A" FORD-ABLE Parts

Rear Inner Fender Panels

Original style.

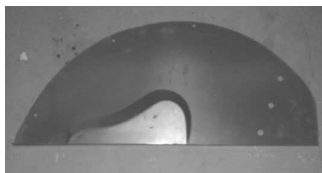

One hump original style.

AM505 28-31

Used on some Fordor Sedans,
Briggs & Murray
15 1/2" High at Ctr x 32.1/2"
Long

Price Pair \$ 54.50

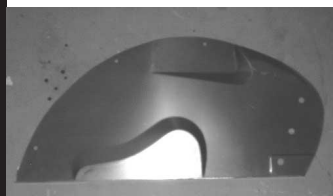

AM502 28-31

Two hump style.
Used on most Ford Bodies
Fordors and Tudor Sedans
15 1/2" High at Ctr x 28 1/2" at
widest Point tapering to 28 1/4"
at base

Price Pair \$ 54.50

Rear Corner Patch Panels

Be Prepared to do some altering to fit on the
30-31. Sorry, but these are the best
available.



AM712 30-31

Tudor Price Pair \$ 36.75

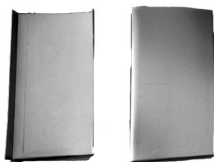

A309DS2 28-29

Tudor Sedan
Price Pair \$ 39.95

1928-1929 Sun Visors

Be Prepared to do some altering
to fit. Sorry, but these are the
best available.



A317A 28-29

Steel - Tudor
Price Ea. \$ 57.75

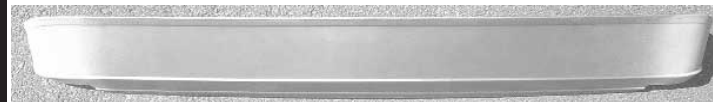

A317BS 30-31

Steel - Tudor
Price Ea. \$ 129.00

Panel above Windshield

This panel fits above the windshield.
3" Tall.



A174A

28-29 Tudor

Price Ea. \$ 65.00

Panel under Visor

This is the panel that covers the front wood header and also is used
for the interior panel to set into.



AM750

28-29 Town Sedan, Fordor Sedan

Price Ea. \$ 68.80

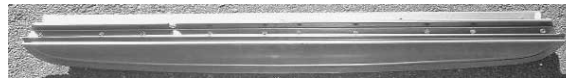

AM753

30-31 Tudor

Price Ea. \$ 88.00

Windshield Header Garnish

The **Slant Windshields** both used this garnish above the wind-
shield. It's also known as the header upholstery retainer.
Primed and ready to paint.



A542

30-31

Price Ea. \$ 89.95

Windshield Filler Trim - Steel



BWO-3031-LS

30-31

Price Ea. \$ 178.00

Header Cover

This is a steel panel that slips over the wood header above the
windshield on the **Tudor Sedans**. This may need some handwork
as it is a handmade piece. Paint Upper Body Color.



A174DS

28-29

Price Ea. \$ 145.00

Mike's "A" FORD-ABLE Parts

Curved Roof Panels (Front) - Tudor

This panel goes above the door to the rib rail. You will have to drill holes to mount the panel and rain gutters.

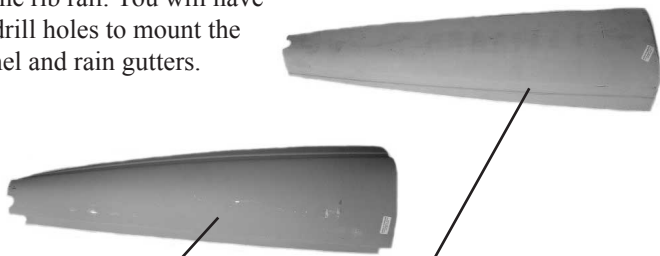

A47775L	28-29	Tudor Left	Price Ea.	\$ 96.00
A47775R	28-29	Tudor Right	Price Ea.	\$ 96.00
A47776L	30-31	Tudor Left	Price Ea.	\$ 125.00
A47776R	30-31	Tudor Right	Price Ea.	\$ 125.00

Curved Roof Panels (Rear) - Tudors Only

This has the roof rib ledge on the inside. It extends approx. 1" beyond the rear roof molding groove, and 1 1/2" below the rain gutter.



A47774L	28-31	Left	Price Ea.	\$ 215.00
A47774R	28-31	Right	Price Ea.	\$ 215.00

Subrails

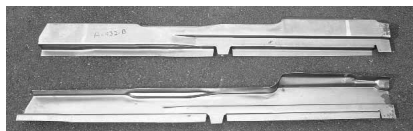

Rear half, from door back.

A432B	30-31	Tudor	Price Set	\$ 150.00
-------	-------	-------	-----------	-----------



Rear half, from door back

A432A	28-29	Tudor Sedan	Price Set	\$ 155.00
-------	-------	-------------	-----------	-----------

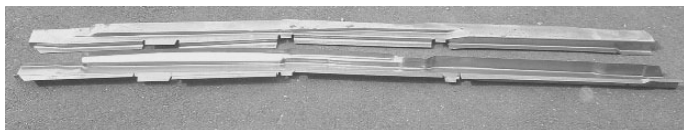

Full Length.

A432BF	30-31	Tudor	Price Set	\$ 280.00
--------	-------	-------	-----------	-----------

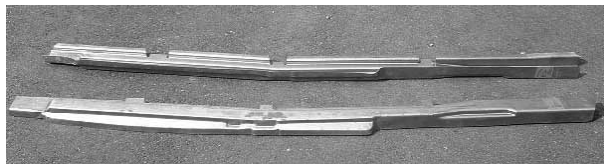

Full Length

A432AF	28-29	Tudor	Price Set	\$ 270.00
--------	-------	-------	-----------	-----------

Subrail Extension - Floor Board Braces

Used on the Front of the Subrails for the Floorboards to mount onto. 4 Pieces.



A132EXB	30-31	All body styles	Price Set/4	\$ 220.00
---------	-------	-----------------	-------------	-----------



A132EXA	28-29	All body styles	Price Set/4	\$ 170.00
---------	-------	-----------------	-------------	-----------

Rear Sub Frame Channel (Rear Cross Member)

Fits below outer panel that ties the Sub Rails together at the back of the car. Includes D-Nuts to mount the Outer Panel and the Spare Tire.



A465AB	28-31	Tudor	Price Ea.	\$ 158.00
--------	-------	-------	-----------	-----------

Door Sill Panel

This metal strip is nailed to the wood subrails on Fordor Sedans.



A48696	30-31	Price Ea.	\$ 46.95
--------	-------	-----------	----------

Mike's "A" FORD-ABLE Parts

Bottom Patch Panel

This beaded patch panel goes on the bottom of the back of the body on **Tudors**.



A850A	28-29	Price Ea.	\$ 32.50
A850B	30-31	Price Ea.	\$ 35.00

Firewall - Original

Lower. Paint Lower Body Color

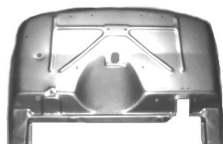

A1015	28-29	Price Ea.	\$ 210.00
A1015B	30-31	Price Ea.	\$ 259.00

Recessed Firewall



A1015AREC4	28-29	4"	Price Ea.	\$ 259.00
A1015AREC5	28-29	5"	Price Ea.	\$ 259.00
A1015BREC4	30-31	4"	Price Ea.	\$ 330.00
A1015BREC5	30-31	5"	Price Ea.	\$ 365.00

Cowl Top Panels

Panel that replaces the Model A Gas Tank, filled style with no hole for the gas filler neck.



A117A	28-29	Price Ea.	\$ 290.00
-------	-------	-----------	-----------



A117B	30-31	Price Ea.	\$ 290.00
-------	-------	-----------	-----------

Hot Rod Upper Firewall



AF118F	28-29	Price Ea.	\$ 90.00
--------	-------	-----------	----------

"T" Strip

Made in the USA. 51" Long, Steel (like original) slightly arched Strip that goes between the Quarter Panels and the Back Panel on **Sedans**.



A170ST	28-31	Sedans	Price Ea.	\$ 38.28
--------	-------	--------	-----------	----------

Door Skins - Closed Cars

Die Stamped panels cover from the bottom of the door - up to the bead.

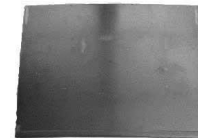

A307CC	28-29	Tudor	Price Ea.	\$ 68.00
A308CS	30-31	Tudor	Price Ea.	\$ 78.00



1931 RHD Fordor belongs to Mr. T. Hermann in South Africa



Sun Visors & Panels

Sun Visors

A little extra fitting may be necessary.



A317A 28-29 Steel - Tudor
 Price Ea. \$ 57.75

Originally these Visors were Covered - See Sun Visor Covers

Paint Body Color

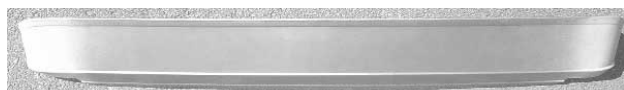

A317BS 30-31 Steel - Tudor
 Price Ea. \$ 129.00

Visor Welt

This goes between the Sun Visor and the Header and is 4' Long.



A3406VW 30-31 Price Roll \$ 1.25

Sun Visor Covers

Originally the '28-'29 Sun Visors were covered.
 Closed Car Only.



All other '28 - '29 Closed Cars
 RSV4/6 Cobra Long Grain
 Price Kit \$ 26.95

Sunvisor Screw Kit (Closed Car)

Oval wood screws and cup washers.
 4 Oval 10-32 x 5/8 metal screws,
 10- #10 x 3/4 Oval Wood Screws
 and 10- #10 cup Washers



A45390 28-29 Price Set/24 \$ 3.45

2-10-32 x 1/4 Flat hd machine scrw



A45391 30-31 Price Set/2 \$ 0.95

Panel above Windshield

This panel fits above the windshield.
 3" Tall.



A174A 28-29 Tudor
 Price Ea. \$ 65.00

Panel under Visor

This is the panel that covers the front of the wood header inside the car and is used for the interior panel to set into.



AM750 28-29 Town Sedan, Fordor Sedan
 Price Ea. \$ 68.80
 AM751 30-31 Fordors (Except S/W)
 Price Ea. \$ 68.80
 AM753 30-31 Tudor
 Price Ea. \$ 88.00

Windshield Header Garnish

The Slant Windshields both used this garnish above the windshield. It's also known as the header upholstery retainer. Primed and ready to paint.



A542 30-31 Price Ea. \$ 89.95

Header Cover

This is a steel panel that slips over the wood



header above the windshield on the Tudor Sedans. This may need some handwork as it is a handmade piece. Paint Upper Body Color.

A174DS 28-29 Price Ea. \$ 145.00

Sun Visor Brackets

Used on Slant Windshields - this nickel plated bracket goes inside the car, above the windshield.



A37164 30-31 Price Pair \$ 140.00

SEDAN

Mike's "A" FORD-ABLE Parts

Wood

Welcome to Mike's Wood Section. We have a complete selection of wood available for all Sedans, made out of the finest wood available. Each Piece is custom made to fit exactly like it was originally made using top quality hardwoods - oak, ash or poplar. We do not stock these items, they will be shipped directly from the manufacturer - separate shipping charges will apply.

UNFORTUNATELY DUE TO THE AMOUNT OF RETURNS INDIVIDUAL WOOD PIECES ARE NO LONGER AVAILABLE.

***** MIKE'S TIPS *****

If you are having a problem with your Doors, or your Hood will not line up with your Radiator Shell and Cowl - additional Shimming is required, usually under the cowl section. Align the hood first, then work back.

Top Wood - All of the wood from the top of the doors up.

Ribs - These go across the roof and support the top.

Belt Rail - Around the edge of the body where the top meets the body.

Body Wood - Structural Wood inside the body - Does NOT include Chassis wood, Belt Rail or Door wood, unless specified.

Headers - Wood above the windshield - Always included in the Top Wood Kits.

Coupe Body Mount Blocks

If your car has wooden sub rails, you don't need these! They go between the steel sub rails and the frame. Complete set per car. Don't forget to order your body block pads A5000P, A5001P and/or Cowl Shims A5002P.

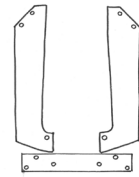

Instructions are included.

AWD1007

28-29

Tudor sedan

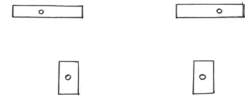

Price Set \$ 32.50

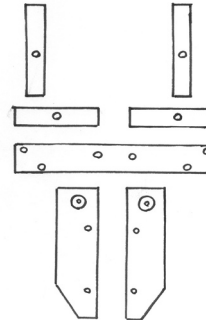

AWD1017

30-31

Tudor Sedan

Price Set \$ 32.50

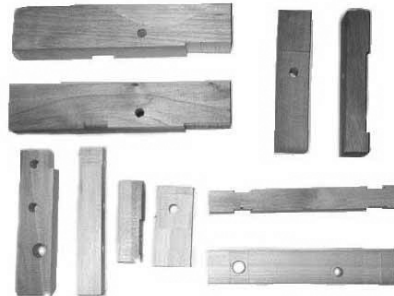

AWDMD

1931

Slant Windshield Fordor

Price Set \$ 37.25

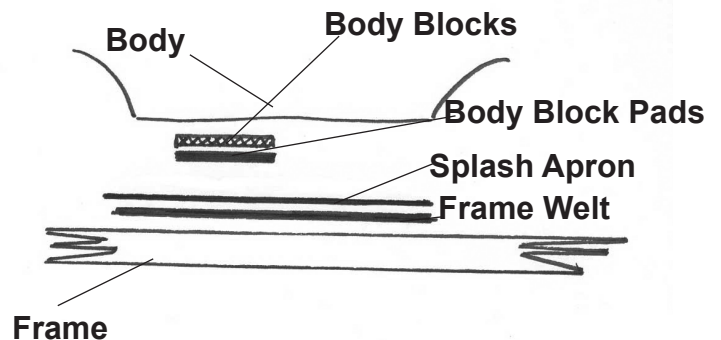

SEDAN

Mike's "A" FORD-ABLE Parts

Sedan Body to Frame Mounting Bolt Sets

Body to frame bolts were different for each year and body style car. These complete kits come with complete instructions.



Tudor
 A90400 28-29 Price Set/44 \$ 9.00
 A90401 30-31 Price Set/42 \$ 8.00

Fordor & Town Sedan
 A90404 28-29 Price Set/54 \$ 9.95

Std. Fordor & Town Sedan
 A90405B 30-31 Price Set/46 \$ 9.95

Deluxe Fordor and S/W Fordor
 A90405A 30-31 Price Set/50 \$ 9.95

Sedan Dome Light Wood Block

This wood block fits between the roof ribs to mount the dome light onto.



Slant Windshield
 A13725 30-31 Price Ea. \$ 9.50



Fordor Sedan.
 A13730 Price Ea. \$ 13.50

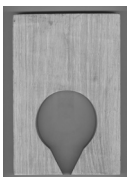

30-31 Tudor
 A13735 Price Ea. \$ 12.00

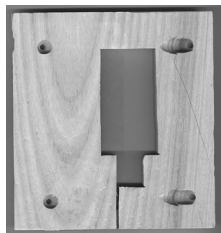

30-31 Murray
 A13740 Price Ea. \$ 17.00

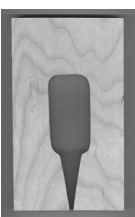

Briggs Fordor - Town Sedan
 A13745 Price Ea. \$ 12.50

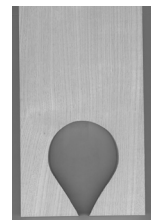

'29 - '31 Briggs Standard & 1929 Steelback Fordor - 60C
 A13750 Price Ea. \$ 12.50

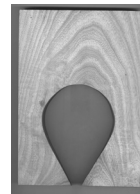

Slant Windshield Fordor - 160A
 A13755 Price Ea. \$ 11.50

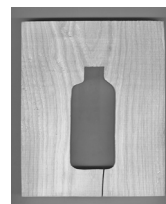

Steelback Fordor - 160B & 160C
 A13765 Price Ea. \$ 13.50

Sedan Latch Wood - Door Lock Cover

This is the latch wood that is mounted vertically about halfway up the door post. Originally this was made of hard rubber.



AWD1280-10 28-29 Tudor
 AWD1281-10 30-31 Tudor Price Pair \$ 15.40

Tudor Sedan Rear Floorboards

The **Tudor Sedan** had a wood floor board instead of metal pan. One goes under the driver's seat and the other in the back seat area.



AWD1256 28-31 Center Price Ea. \$ 33.00

AWD1258A 28-29 Rear Price Ea. \$ 33.00

AWD1258B 30-31 Rear Price Ea. \$ 33.00

Mike's "A" FORD-ABLE Parts

Sedan Headers

AWD1025-1	28-29	Tudor Sedan 55A Price Ea. \$ 68.00
AWD1027-1	30-31	Tudor 55B Price Ea. \$ 89.50
AWD1060-1	30-31	Slant Windshield Fordor 160A, B & C Price Ea. \$ 89.50
AWD-GA-1	1929	Briggs Fordor Steelback 60C & Town Sedan 155B, 165B & 170A Price Ea. \$ 100.00
AWD-HA-1	28-29	Briggs Fordor Leatherback 60A & 60B Price Ea. \$ 130.00
AWD-IA-1	30-31	Murray Fordor 155C & 165C Price Ea. \$ 108.00
AWD-JA-1	30-31	Briggs Fordor 155D, 165D & 170B Price Ea. \$ 96.00
AWD-NA-1	1929	Murray Town Sedan 155A & 165A Price Ea. \$ 101.00

Sedan Top Wood Kits

Includes Header. Everything above the door opening.

AWD1025	28-29	Tudor Sedan 55A Price Kit \$ 345.00
AWD1027	30-31	Tudor Sedan 55B Price Kit \$ 368.00
AWDFA	1929	Briggs Fordor 155B, 165B & 170A Price Kit \$ 820.00
AWDGA	1929	Briggs Fordor Steelback 60C Price Kit \$ 820.00
AWDHA	28-29	Briggs Fordor Leatherback 60A & 60B Price Kit \$ 840.00
AWDIA	30-31	Murray Fordor 155C & 165C Price Kit \$ 820.00
AWDJA	30-31	Briggs Fordor Town Sedan 155D, 165D & 170B Price Kit \$ 820.00
AWDMA	1931	Slant Windshield Fordor 160A, B & C Price Kit \$ 405.00
AWDNA	1929	Murray Fordor 155A & 165A Price Kit \$ 820.00

Sedan Body Wood Kits

Body Shell wood less Top, Chassis & Door Wood.

AWD1280	28-29	Tudor Sedan 55A Price Kit \$ 245.00
AWD1281	30-31	Tudor Sedan 55B Price Kit \$ 245.00
AWD1296	1931	Slant Windshield Fordor 160A, B or C Price Kit \$ 285.00
AWDFB	1929	Briggs Fordor 155B, 165B or 170A Price Kit \$1325.00
AWDGB	1929	Briggs Fordor Steelback 60C Price Kit \$1325.00
AWDHB	28-29	Briggs Fordor Leatherback 60A & 60B Price Kit \$1720.00
AWDIB	29-31	Murray Fordor 155A, 165A, 155C or 165C Price Kit \$1335.00
AWDJB	30-31	Briggs Fordor 155D, 165D & 170B Price Kit \$1325.00

Sedan Chassis Wood Kits

Sills & Crossmembers.

AWD1380	1929	Murray Fordor Town Sedan 155A & 165A Price Kit \$ 662.00
AWDFC	1929	Briggs Fordor Town Sedan 155B, 165B & 170A Price Kit \$ 662.00
AWDGC	1929	Briggs Fordor Steelback 60C Price Kit \$ 662.00
AWDHC	28-29	Briggs Fordor Leatherback 60A & 60B Price Kit \$ 662.00
AWDIC	30-31	Murray Fordor Town Sedan 155C & 165C Price Kit \$ 662.00
AWDJC	30-31	Briggs Fordor Town Sedan 155D, 165D & 170B Price Kit \$ 662.00

Sedan Door Wood Kits

AWDHB-4	28-29	Briggs Fordor Leatherback 60A & 60B Price Kit \$1260.00
AWDIB-4	29-31	Murray Fordor 155A, 165A, 155C & 165C Price Kit \$1000.00
AWDJB-4	29-31	Briggs Fordor 60C, 155B, 170A, 155D, 165D & 170B Price Kit \$1000.00

Mike's "A" FORD-ABLE Parts

Sedan Seat Frame Wood Kits

AWD1408	28-31	Tudor 55A & 55B Front Cushion 2 Required	Price Ea.	\$ 36.00
AWD1409	28-31	Tudor 55A & 55B Front Seat Back Nailer - 2 Required	Price Ea.	\$ 2.65
AWD1500	1931	Slant Windshield Fordor 160A, B & C Front Cushion	Price Ea.	\$ 76.50
AWD1503	30-31	Briggs Fordor 155D, 165D & 170B Front Cushion	Price Ea.	\$ 82.00
AWD1512	28-31	Tudor 55A & B Rear Cushion	Price Ea.	\$ 82.00
AWD1513	28-31	Tudor 55A & B Rear Backrest	Price Ea.	\$ 82.00
AWD1516-L	30-31	1931 Deluxe Tudor Sedan Left Front Seat Bottom - Adjustable Seat	Price Ea.	\$ 54.00
AWD1516-R	30-31	1931 Deluxe Tudor Sedan Right Front Seat Bottom - Adjustable Seat	Price Ea.	\$ 54.00

Wood Kit Bolt Sets

Complete Bolt set for wood sets. A limited selection available at the moment, but more will be following soon.

Tudor Sedan Top Wood Bolt Set

451 Piece Set.

AWD-1025-KIT 28-29 Price Set \$ 27.95

Tudor Sedan Front Header Screw Set

10 Piece Set.

AWD-1025-1-KIT 28-29 Price Set \$ 5.25

Tudor Sedan Top Wood Bolt Set

188 Piece Set

AWD-1027-KIT 30-31 Price Set \$ 27.95

Body Nails

Commonly used on all Model "A's"



Nail Style #3

.074 diam. x 3/4" long - oval head - pack of 100

Price Pack \$ 1.50

Nail Style #4

Top Mouldings & Rain Gutter - .085 x 7/8" long - pack of 100

Price Pack \$ 1.50

Nail Style #5

Use these where rusting could occur - Stainless Steel .085x 3/4" long - pack 100

Price Pack \$ 3.00

Roof Tacks

This is a set of 100 zinc plated tacks used to tack the black vinyl decking to the wood top frame. The top molding covers these tacks.



A38425MBR

28-31

Price Pack \$ 2.25



1930 RHD Tudor belongs to Mr. T. Bunge of South Africa.

SEDAN

Mike's "A" FORD-ABLE Parts

Spare Tire

Only Sedan specific items are listed here, for more Spare Tire related items and accessories see page Gen. 39.

Rear Spare Tire Carrier

Carrier for the Sedans. Cast aluminum. Studs included. Paint black.



Tudor & Some Fordors.

A1380AR 28-31

Price Ea. \$ 35.95

Rear Spare Wheel Mount to Body Bolts

Bolts for the Sedans.



A1379BMB 28-31 3 bolts 3 l.w. & 1 nut

Price Set /7 \$ 2.50

Spare Tire Brace

This brace supports the inside of the outer panel for the spare tire bracket. Can be used on '28-'29 panels, but must be shortened to fit.



A163ABR 28-31

Price Ea. \$ 21.00

Order Online Now and Save 5%

Visit our website for all your Model "A" needs.



www.mikes-afordable.com

Rear Fenders & Brackets

As front fenders are generic to all Model A's they are still in there own Section - See Page Gen. 200 For Front Fenders

Sedan Rear Fenders

Please read carefully before purchase.

Fiberglass Fenders - A complete line of fiberglass fenders are available. These are all hand laminated with fiberglass matte and special resins to achieve the optimum in strength.

Please Note: Additional shipping will apply due to large boxes. These are special orders, please allow three to four weeks for delivery. Rear fenders will be shipped by courier and are charged according to the box size.

Steel Fenders - It is important when fitting sheet metal to your car to FIRST fit before painting or drilling any holes. Many times it is necessary to use C-Clamps, vise grips or a drift pin to locate holes for alignment. In order to secure a proper fit and alignment, it is normally necessary to loosen all attaching sheet metal parts. Some reworking may be necessary as mating parts many come from different suppliers or new parts versus 80 year old parts are placed together. Some metal parts may have been treated with oil or may still have residue from forming oils. It is necessary to thoroughly clean the metal with a metal prep or solution to remove all oils and / or fingerprints before painting.

NO RE-WORKED, RUSTED OR PAINTED FENDERS ARE ACCEPTABLE FOR RETURN.

Sedan Rear Fiberglass Fenders:

1928 - 1929

F16311A	Left	Price Ea.	\$ 199.00
F16310A	Right	Price Ea.	\$ 199.00

1930 - Early 1931

F16311B	Left	Price Ea.	\$ 199.00
F16310B	Right	Price Ea.	\$ 199.00

Sedan Rear Steel Fenders:

These are very well-made reproductions using the same gauge steel as Ford used.

Please read the instructions above.

Sold in Pairs ONLY.



A16160/61D	28-29	Left & Right	Price Ea.	\$ 310.00
------------	-------	--------------	-----------	-----------

A16160/61C	30-31	Left & Right	Price Ea.	\$ 310.00
------------	-------	--------------	-----------	-----------

Mike's "A" FORD-ABLE Parts

Rear Fender Bracket

Here are the pressed steel rear fender brackets for the **Fordor** and **Tudor Sedans**.



A16180D 28-31 Price Ea. \$ 24.70

Rear Fender Bracket Bolts

This set of bolts and castle nuts will attach both rear fender brackets to the body.



A16181MB 29-31 6 5/16" - 24 x 1" + l.w. & nuts
Price Set/10 \$ 2.50

Rear Fender Washers & Nuts

If your studs (**A081MB**) are OK, then this set of 8 Flat Washers, Lockwashers and 5/16-18 Nuts are used to mount rear fenders to body.



A16195 29-31 Price Set/24 \$ 1.50

Rear Fender Mount Studs

These are the special oversized head bolts that get welded or brazed to the body to mount the rear fenders on.



A081MB 28-31 4 studs needed per fender
Price Ea. \$ 0.50

Fender Welt

Mike has this 17 foot roll of the 3/16" black beading used on the fenders.



A3404FW 28-31 Price Ea. \$ 9.90

Rear Bumper Brackets

These brackets extend from the frame to mount the rear bumper. The stands come attached. This bracket is bolted UNDER the top of the frame, approx. 6" in front of the rear crossmember.



A17777A 28-29 Sedan - 3 1/4" Stands
Price Pair \$ 150.00

A17777B 30-31 Sedans & Fordor 4 3/4" stands -
NOT for Slant Windshields
Price Pair \$ 150.00

Rear Bumper Bracket to Frame Bolts

This set of nuts, bolts and lock washers has everything you need to install the rear bumper brackets to the frame. The end of the bumper bracket is bolted under the top of the frame, about 6" in front of the rear crossmember.



4 x 3/8 - 24 x 1" - on frame
2 x 7/16 - 20 x 1" - on frame
4 x 5/16 - 18 x 3/4" bolts, l.w. & nuts - on Body Stands
A17779X 28-31 Price Set/30 \$ 5.95

Rear Bumper Bracket-Body Stand

Made in the USA. You will need two of these brackets which support the bumper brackets toward the rear of the car.

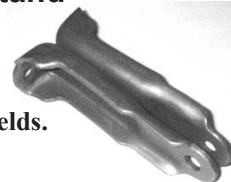

Note: **A17830B** is not for Slant Windshields.

A17830B 30-31 Sedans - Not Slant Windshield -
4 3/4" Price Ea. \$ 14.00

A17830A 28-29 Sedans - 3 1/4" Price Ea. \$ 14.00

Rear Bumper Bracket to Stand Rivets

If you need to replace the stands here are the rivets that you will need.



RA1005 Price Ea. \$ 1.00

Mike's "A" FORD-ABLE Parts

Hood

Hood Handle

These are pressed steel handles which mount in the middle of the side panels to lift the hood.

Rivets Included.

Use Rivet Tool RA2022 on Page Gen. 28.

A16609 28-31 Price Pair \$ 24.95

Comes with A16755 Modern Rivet Style

A16609SS 28-31 Stainless Price Pair \$ 30.75



Hood Latch Brackets

This is a complete set of brackets and hardware that the hood latch hooks onto. Use rivets A16753.

If you are using rivets, use Rivet Tool RA2022 on Page Gen. 28.

A16750CL 28-31 Price Set/16 \$ 4.95

Comes with A16753 Original Rivets, or you can order A16755 Modern Style separately.

A16750HCSS 28-31 Stainless Price Set/16 \$ 12.05

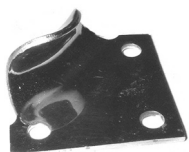

Hood Handle & Latch Clip Rivet Set

Original style rivets for the hood handles and clip brackets. Use RA2022 Rivet Tool on Page Gen. 28.

A16753 Price Set/20 \$ 2.00



Modern Style Hood Handle & Latch Clip Screw Set

These screws are used on the Hood Handles and Hood Clips - not original.

These are stainless round head screws with nuts that look like rivets from the outside. No riveting needed!!

A16755 Price Set/20 \$ 4.95



Hood Prop Kit

These stainless steel props are an important add-on for safety. The kit bolts onto the radiator braces and the fold out arms are rubber-coated to rest the hood on.

A16613SS 28-31 Price Kit \$ 24.95



Hood Safety Supports

Mounts on the hood rods, and hooks to hood rod bracket on firewall. When you raise the hood, set the bottom edge of the hood on the hooked end of the arm - protective plastic covers the wire. Set includes left and right side wire. Instructions included.

A16714A 28-29 Price Set \$ 21.95

A16714B 30-31 Price Set \$ 21.95



Early '28 Hood (All Early '28 Cars)

The early '28 hood louvres were all the same length. From mid '28 the top of the louvres on the side had a slight taper. Trophy Quality. Paint Underside Lower Body Color. Includes Handles A16609 and Hood Clip Brackets A16750CL and Steel Hood Rods.

A16610AR 1928 Price Ea. \$ 405.00



1928-29 Fordor Sedan Hood

This hood is for the 1929 Briggs Fordor, 60A, B & C & 155B, 1929 Murray Fordor, 155A & 165A & 1929 Cabriolet 68A only.

Trophy Quality. Paint Underside Lower Body Color. Has a bead on the side of the top panel and a different cowl contour. Includes Handles A16609 and Hood Clip Brackets A16750CL.

A16610ABR 28-29 Price Ea. \$ 405.00



1928-29 Stock Hood

This hood fits the '28-'29 Model A's except for the Fordor Sedans (see A16610ABR). Trophy Quality. Paint Underside Lower Body Color. Includes Handles A16609 and Hood Clip Brackets A16750CL.

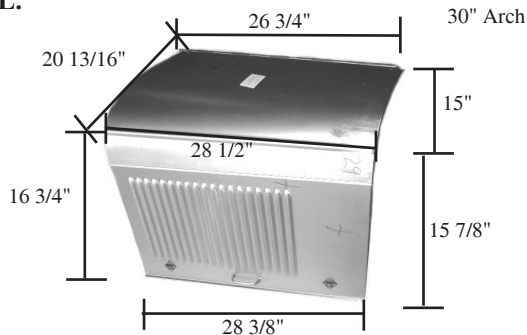

A16610A 28-29 Price Ea. \$ 380.00

Mike's "A" FORD-ABLE Parts

1930-31 Stock Hood

All the '30-'31 Model A's used this hood. Trophy Quality. Paint Underside Lower Body Color. Includes Handles A16609 and Hood Clip Brackets A16750CL and Steel Hood Rods.

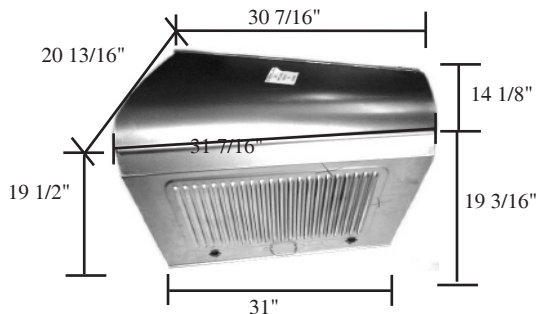

A16610B 30-31 Price Ea. \$ 420.00

Stainless Hood Rods

Complete set of three hood rods. After punching these rods out about 1", use a variable speed drill, chuck it to the rod and spin the rod as you pull it out.



A16611A 28-29 27 3/4" Long Price Set/3 \$ 14.95

A16611B 30-31 30 1/2" Long Price Set/3 \$ 14.95

Hood Corners

Triangle leather hood corners originally were on the rear only.

Use Rivet Tool RA2022 on Page Gen. 28. Rivets to be painted black.

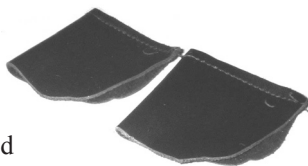

A16622LS 28-31 9/64 x 5/16 tubular rivets Price Pair \$ 3.90

Hood Corners

These are molded rubber hood corners; look good. Use Rivet Tool RA2022 on Page Gen. 28.



A16622RS 28-31 Price Pair \$ 3.90

Hood Shelf

Not used on 1930-1931. See diagram on page 248. Don't forget A16727S Blocks.



A16713/14 28-29 Price Pair \$ 33.95

Hood Shelf Blocks

These wooden blocks go under the hood shelf. They act as spacers to mount the hood latch.

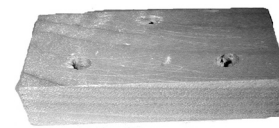

A16727S 28-29 Price Set/40 \$ 6.75

Center Hood Bracket

Attaches to the frame with rubber bumper (A16761B - See Page Sedan 20) against the hood to prevent rattles.



A16718S 30-31 Price Set/12 \$ 5.50

Hood Retainer (Front)

The center hood rod hooks onto this clip on the radiator shell. Paint Black



A8220C 28-31 Price Ea. \$ 3.15

Hood Retainer Mount Set (Front)

A pair of tube rivets to mount the center hood rod brackets. Use Rivet Tool RA2022 Page Gen. 28.



A8220MB 28-31 Price Pair \$ 0.50

Hood Rod Retainer (Rear)

This is the rear retainer for the hood. Paint body color.

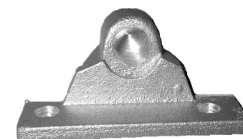

A16735A 28-29 Price Ea. \$ 5.10

Standard Hood Hinge Rod Retainer (Rear)

Same as above but for different years. Paint body color.

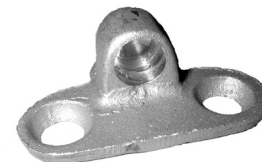

A16735B 30-31 Price Ea. \$ 4.95

Deluxe Hood Hinge Rod Retainer (Rear) Chrome

This serves the same purpose as A16735B, but has a finger which clamps over the cowl band. Normally only used on Deluxe '30-'31 Models. Order A16735BMB (Page Sedan 19) Screws.



A16735C 30-31 Price Ea. \$ 8.75

INSTALLATION OF HOOD SHELF FOR 1928 - 1929 ONLY

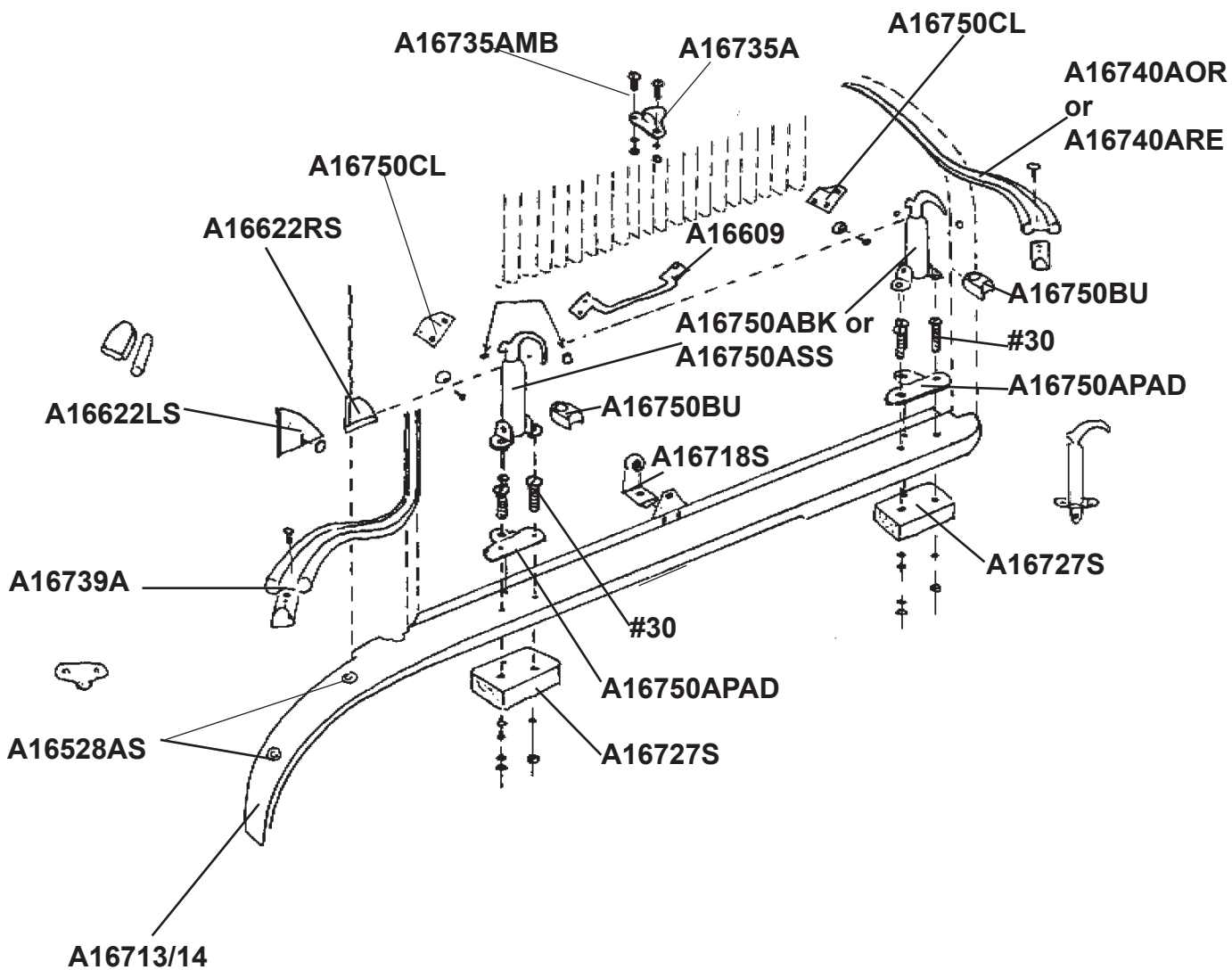

SEDAN

Mike's "A" FORD-ABLE Parts

Retainer Mounting Screws (Rear)

Screws to mount the rear hood retainer to the firewall.



A16735AMB 28-29 2 x 12-24" x 5/8" round head
Price Set/6 \$ 0.95



A16735BMB 30-31 2 x 12-24" x 5/8" flat head
Price Set/4 \$ 0.95

Hood Retainer Shims

Having alignment problems with your hood? Place these steel shims between the rear hood retainer and the cowl. Will help if the bottom of the hood is hitting on the radiator shell.

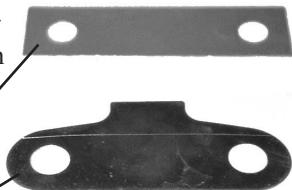

A16736A 28-29 Price Ea. \$ 0.55
A16736B 30-31 Price Ea. \$ 0.60

Cowl Band

This is a well made stainless steel reproduction. These '30-'31 reproduction bands will not fit the '28-'29's. These were usually painted black on all Commercial Trucks. Special box for UPS - additional shipping charges do apply.

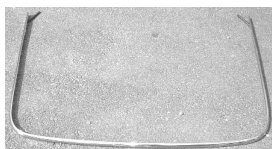

A16737CB 30-31 Price Ea. \$ 73.00

Cowl Band Clips

These clips go under the cowl panel screws on the firewall and slip under the cowl band to hold it in place.



A16738CL 30-31 Price Pair \$ 3.35

Radiator Shell Lacing

This is a double beaded lacing for the radiator shell, comes with raven rivets.



A16739A 28-29 Price Set/25 \$ 6.75
A16739B 30-31 Price Set/25 \$ 9.00

Cowl Lacing Hook

This is the special hook that the wire attaches to, to hold the cowl lacing on. **10-32 x 3/4"** Special Clamp Screw
Used with original **A16740AOR**.
Not included in lacing Kit **A16740ARE** or **AOR**.



A16739AC 28-29 Price Set \$ 1.95

Cowl Lacing Kit & Rivets

Two types are available for the '28-'29 A's. The original used wire to hold the lacing down on the gas tank and rivets on the cowl panels. Use Rivet Tool **RA2022** on page Gen. 28.



A16740ARE 28-29 Replacement Price Kit \$ 8.60
A16740AOR 28-29 Original Price Kit \$ 12.75

Cowl Lacing Screws

Special pan headed replacement screws for installing the '30-'31 cowl lacing. Included in the cowl lacing kit (**A16740BS**). One for each side and the third top center. **3 x 12-24 pan head screws**



A16740MB 30-31 Price Set/3 \$ 0.75

Authentic Cowl Lacing Kit

Just like the original for '30-'31 A's. Complete with all clips, screws, and rivets. Use rivet Tool **RA2022** on page Gen. 28.



A16740BS 30-31 Price Kit/10 \$ 15.45

1930-31 Cowl Lacing Clip

Replacement clips for the '30-'31's if you've lost some. Included with kit **A16740BS**.



Use Rivet Tool **RA2022** on page Gen. 28.
A16737 30-31 Price Ea. \$ 0.75

Cowl or Radiator Rivets

This is a package of 24 raven-finished split rivets to attach the hood lacing.



A16745 ANY Price Set/24 \$ 1.20

Hood Latch Repair Kit

If possible try to repair your original latch handles. Our set does all 4 latches and comes with complete instructions.



A16749 28-31 Price Set/12 \$ 12.50

Mike's "A" FORD-ABLE Parts

Hood Latch Handle

We have both the original black three-hole handles as well as stainless steel.



A16750ABK 28-29 Black
Price Ea. \$ 8.25

A16750ASS 28-29 Stainless - 3 Hole Mounting
Price Ea. \$ 11.00



#30 28-29 Hood Handle Screws
Price Set/36 \$ 2.25

Hood Latch Pads

These 4 rubber pads go under the hood latches.



A16750APAD 28-29 Price Set/4 \$ 8.25



A16750BPAD 30-31 Price Set/4 \$ 4.10

Hood Latch Handle

We have both the original black two-hole handles plus modern stainless steel.



A16750BBK 30-31 Black
Price Ea. \$ 8.25

A16750BSS 30-31 Stainless - 2 Hole Mounting
Price Ea. \$ 11.00



#32 30-31 Hood Handle Screws
Price Set/24 \$ 2.25

Hood Latch Rivet Kit

These tiny rivets connect the body of the hood latch to the mounting bracket. Use Rivet Tool RA2022 on page Gen. 28.



A16751 28-31 Price Set/4 \$ 0.50

Hood Latch Caps

This set of 8 rubber caps protects your finish from being scratched. 1 Set will do all four handles.



A16750CS 28-31 Price Set/8 \$ 1.45

Hood Latch Bumper

Set of 4 rubber bumpers that fit over the hood latch stem to reduce rattles. This Latch bumper set cannot be used if you are using the Hood Bumper Set A16761 or A16761B.



A16750BU 28-31 Price Set/4 \$ 3.00

Hood Bumper Set

Complete set of 6 round rubber hood bumpers with rivets. Four for the hood and two for the centre hood braces. Place one under each hood clip plus one on each support clip.

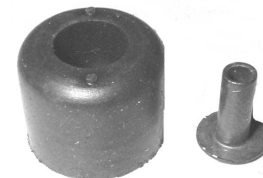

Use Rivet Tool RA2022 on page Gen. 28.

A16761 28-31 from Aug 28 to May 31
Price Set/12 \$ 3.50

Hood Bumper Set

Complete set of 2 round rubber bumpers for the inside center support plus 4 triangular ones to go under each hood clip. The supplier ships with rivets which is correct, but Mike recommends using rivet head screws and nuts to keep them in place.



A16761B 1931 May 31 'til end
Price Set/12 \$ 3.75

Rear Spring

For more spring related items see page
Gen. 98 of our general section.

Sedan Rear Leaf Spring

A good reproduction of the original.
Clamps NOT included.

For Clamps, bushings, Bolts and
Nuts See Page Gen. 99 & 100..



A5560A

10 Leaf 28-31 Tudors & Fordors

Price Ea. \$ 225.00

1931 Deluxe Tudor belongs to Mr. & Mrs. B. Delong.



SEDAN

Mike's "A" FORD-ABLE Parts

Sedan Windshield

Sedan Windshield Frame

These windshield frames are good aluminum reproductions of the originals. They come with frame gasket Only. Hinge gasket may be needed. 1928 - 1931 Tudors and Most Sedans.



A45410AR	28-29 16 1/4" High	Price Ea.	\$ 180.00
A45410A	30-31 16 1/4" High	Price Ea.	\$ 180.00

Same as above but these are for 1931 Slant Windshield Fordors.

A45410E	1931 14 1/2" High	Price Ea.	\$ 180.00
---------	-------------------	-----------	-----------

Show Quality Sedan Steel Un-Finished Windshield Frame

This top quality frame comes with the correct swing arm brackets, frame gaskets, and assembly tools. **Right Hand drive is available upon request. Some sanding required.**



28-5410U	28-29	Price Ea.	\$ 445.00
30-5410U	30-31	Price Ea.	\$ 445.00

Closed Car Windshield Frame Screws

When you need to replace the glass in your windshield you should take this opportunity to replace the screws in your windshield frame.



#47	28-31	Price Set/8	\$ 2.00
-----	-------	-------------	---------

Closed Car Windshield Frame Gasket

This gasket goes on the bottom (put in first) and sides of the steel windshield frame. Rubber gaskets stretch when you install them so wait a day to trim for a tighter fit.



A79500	26-31	Price Ea.	\$ 3.50
--------	-------	-----------	---------

Closed Car Windshield Frame Gasket (Aluminum Frame)

For the aluminum frame, this is the gasket to use. This does the bottom and both sides but wait a day to trim because of stretch.

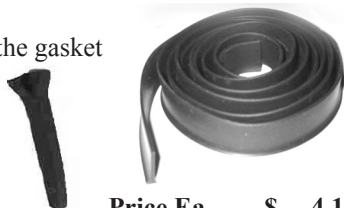

A79501	28-31	Price Ea.	\$ 4.15
--------	-------	-----------	---------

Closed Car Slant Windshield Gasket

This is the special gasket needed for the **Slant Windshields**. This has the special hinge, 2 sides and the bottom gasket you'll need.



A79551BR	1931	Price Set	\$ 19.95
----------	------	-----------	----------

Closed Car Glass Bedding

The correct cork / neoprene bedding to be used for setting the glass in the windshield frame.

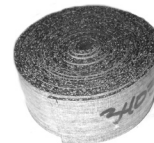

A3403X	28-31	Price Roll	\$ 7.50
--------	-------	------------	---------

Closed Car Windshield Bracket

This bracket is an exact duplicate of the '28-'29 originals Includes rivets.



A45471A	28-29	Price Ea.	\$ 9.95
---------	-------	-----------	---------

Closed Car Windshield Bracket

This bracket is an exact duplicate of the '30-'31 originals for all Sedans. Includes Rivets.



A45471B	30-31	Price Ea.	\$ 9.95
---------	-------	-----------	---------

Closed Car Slant Windshield Bracket

A duplicate of the original bracket used on the 1931 Slant Windshield.



A45471SW	1931	Price Set	\$ 14.95
----------	------	-----------	----------

Closed Car Windshield Hinges

These aluminum hinges for the Sedans have to be drilled out and have tapers cut on the ends.



A45411AR	28-29	Price Ea.	\$ 11.30
A45411A	30-31	Price Ea.	\$ 11.30

Closed Car Windshield Hinge Gasket

This gasket is critical to keep out water. It fits between the windshield hinge and the header. The small round edge is exposed to the outside.



A79550	28-31	Price Ea.	\$ 3.00
--------	-------	-----------	---------

Mike's "A" FORD-ABLE Parts

Closed Car Windshield Hinge to Header Screws

A complete set of screws to attach the hinges to the header on the Closed Cars.



A30200 28-29 6 1/4-20 x 1/2" round head screws, 4 10/32 x 3/8 flat, 2 10/32 x 1/2 Oval & 2 3/8 x 10/32 square Nuts.
Price Set \$ 1.80



A30210 30-31 10 - #10 x 1" round head wood screws
Price Set \$ 1.00

Closed Car Windshield Hinge Screws - Interior

5 - #10 x 3/4" flat head wood screws attach to inside of the windshield to secure the Windshield hinge to the header.



A30220 28-31 Price Set \$ 0.50

Windshield Header Brackets

Use this metal bracket to connect the wood header to the side wood body rail.

Used on:

30-31 Tudor



RAR218 30-31 Price Pair \$ 42.00

Windshield Header Bracket Screws

8 - 5/16-18 x 2" flat head screws. Two screws go forward into the header and two at a right angle, into the wood side rail.

Also 6 - 12/24 x 5/8" flat head screws and 6 1/4" external, counter sunk lock washers to mount the brace to the vertical top.



A40130 28-31 Price Set \$ 2.75

Header Cover

This is a steel panel that slips over the wood header above the windshield on the **Tudor Sedans**. This may need some handwork as it is a handmade piece. Paint upper Body color.



A174DS 28-29 Price Ea. \$ 145.00

Closed Car Windshield Garnish

This steel garnish screws to the windshield posts on both sides of the windshield opening on the closed cars.



A45483A 28-29 Steel - Tudor
Price Pair \$ 48.75

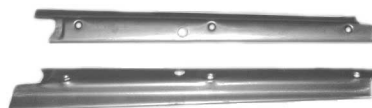

A45483 30-31 Steel - Tudor
Price Pair \$ 46.50

A45483S 30-31 Stainless - Tudor & some Fordors
Price Pair \$ 63.25

Garnish Molding Screws

These screws are 10/32 x 1/2" to attach the garnish molding to the door.

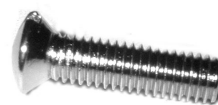

A342S 28-31 Price Ea. \$ 0.15

Closed Car Tube Nuts

#6-32". You'll need three tube nuts per door to mount the window garnish molding on the **Briggs Straight**

Windshield Fordors. Included in Interior Trim Kits.

A45484 28-31 - Set of 6 Price Set \$ 3.55



#8-32". You'll need ten tube nuts per door to mount the window garnish molding on the **Slant Windshield Fordors**. Included in Interior Trim Kits.

A45483T 1931 - Set of 10 Price Set \$ 4.50



Filler Trim

This panel goes above the gas tank at the back edge on '30-'31's. The lower part of the windshield closes against this.



BWO-3031-LS 30-31 Price Ea. \$ 178.00

Closed Car Swing Arms

These are the arms that pivot to hold the windshield out for fresh air or close and seal the glass shut.



A45463S 28-31 Price Pair \$ 9.95

Mike's "A" FORD-ABLE Parts

Accessory Style Swing Arms

These arms have notches in them so that the arms are sure not to move or slide.

Once you use these you'll be hooked.

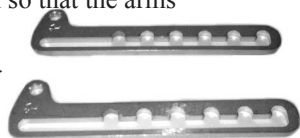

A45463N 28-31 Price Pair \$ 29.95

Closed Car Windshield Frame Nut

This is the special nut that goes on the windshield frame to attach the swing arm to. Need 2.



A45475NUT 28-31 Price Ea. \$ 1.45

Closed Car Pivot Bolt & Nut

This kit has the hardware to hold the swing arm to the windshield frame on both sides.



A45475S 28-29 Price Set \$ 2.70

The '30-'31's Windshields did not use sleeve nuts. The A45475NUT was used for nuts.



A45476B 30-31 Price Set \$ 0.75

Closed Car Swing Arm Washers

You need one set of these for your car. These are chrome cup-shaped washers with rubber inserts that go on the swing arms.



A45477S 28-31 Price Pair \$ 2.50

Closed Car Swing Arm Nuts

These are the chrome-plated nuts that hold the swing arms in place when you open the windshield.

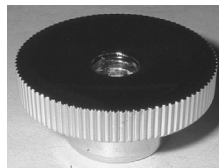

A45482 28-31 Price Pair \$ 6.95

Installation of Swing Arms

A45475S - 28-29
A45476B - 30-31

A45477S on both side
of Swing Arms

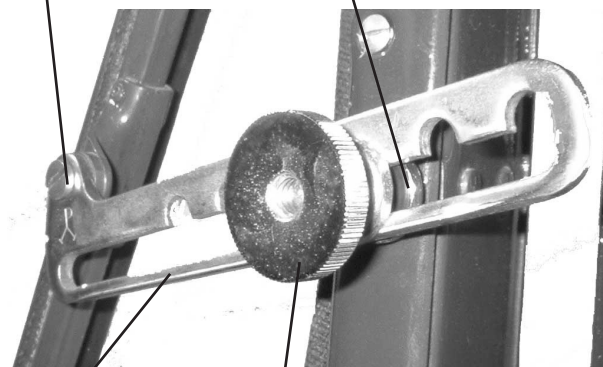

A45463N

A45482

Sunvisor Screw Kit (Closed Car)

Oval wood screws and cup washers.

4 Oval 10-32 x 5/8 metal screws,
10- #10 x 3/4 Oval Wood Screws
and 10- #10 cup Washers



A45390 28-29 Price Set/24 \$ 3.45



2-10/32x1/4Flat hd machine screw

A45391 30-31 Price Set/2 \$ 0.95

Visor Welt

This goes between the Sun Visor and the Header and is 4' Long.



A3406VW 30-31 Price Roll \$ 1.25

Closed Car Sun Visor Brackets

Used on **Slant Windshields** - this nickel plated bracket goes inside the car, above the windshield.



A37164 30-31 Price Pair \$ 140.00

SEDAN

Mike's "A" FORD-ABLE Parts

Glass Sets

PLEASE NOTE: All glass is clear AS1 safety glass 1/4" thick. This safety glass works very well and presents no fitting or installation problems. Your glass will be shipped by UPS in special boxes that will ensure safe delivery. Most shipments will be made within 14 working days of the receipt of your order and WILL require additional shipping charges. Shipping charges do apply to glass picked up at our store.

The following codes are used below to describe the glass:

W = Windshield D = Door Glass

Q = Quarter Glass B = Back Glass

Where "DD" appears it indicates 2 Door Windows, "QQ" indicates 2 Quarter Windows, ETC.

PLEASE MAKE SURE TO SPECIFY THE EXACT YEAR AND BODY STYLE OF YOUR CAR.

W, DD, QQ, B - Tudor 55A
(Back Window is 10 7/8" @ center)
AG21A 1929 Price Set \$ 385.00

W, DD, QQ, B - Tudor 55B
(Back Window is 10 5/8" @ center)
AG21B 1929 Price Set \$ 385.00

W, DD, QQ, B - Tudor 55B
AG22 30-31 Price Set \$ 385.00

W, DDDD, B - Fordor - 2 Window 60A & 60B
AG23 28-29 Price Set \$ 357.50

W, DDDD, B - Fordor - 2 Window 60C, 170A & 170B
AG24 29-30 Price Set \$ 374.00

W, DDDD, QQ, B - Standard Fordor and Town Sedan Slant
Windshield 160A & 160B
AG26 Late 1931 Price Set \$ 451.00

W, DDDD, QQ, B - Deluxe Fordor - 2 Window Slant
Windshield 160C
AG27 Late 1931 Price Set \$ 451.00

W, DDDD, QQ, B - Fordor and Town Sedan (Murray) 155A,
155C, 165A, 165C
AG33 29-31 Price Set \$ 473.00

W, DDDD, QQ, B - Fordor and Town Sedan (Briggs) 155B,
155D, 165B, 165D
AG34 30-31 Price Set \$ 451.00

Individual Glass Pieces

One Piece Windshield - Closed Car - SPECIFY
AGW1 28-31 Price Ea. \$ 121.00

Door Window - Any Body Style - SPECIFY
AGD2 28-31 Price Ea. \$ 72.60

Quarter Window - Tudor Only
AGQ4 28-31 Price Ea. \$ 79.20

Back Window - Any Body Style - SPECIFY
AGB5 28-31 Price Ea. \$ 58.30

Ford Script Logo Etched on Glass

1928 - 1929 Windshields for cars.



A94999A 28-31 Price Ea. \$ 16.50

1930 - 1931 Windshields for Cars
May 1931 thru 1931 all glass optional.



A94999C 30-31 Price Ea. \$ 16.50

Ford Script Logo Etched on Glass

1928 - 1929 Windshields for cars.



1928 RHD Tudor Sedan owned by Mr. & Mrs. O. Hart of Pinetown, Natal, South Africa.

Mike's "A" FORD-ABLE Parts

Windshield Wipers

Electric Wiper Motor

This is a universal 6-volt motor that mounts on the inside of the car. The shaft is sleeved and threaded to hold it in place. **Does not include wiper blade and arm.**

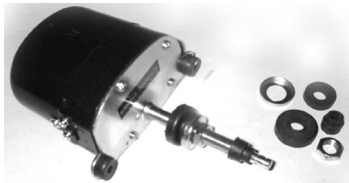

110 Degree Sweep.

Black Housing - With On - Off Switch. - 1928-1931.

The 6 Volt shaft can be adapted from the 3 1/4" to 2 1/2" if necessary. Unless you adapt the motor to go thru the windshield frame with an angled hole, you will not be able to open the windshield.

For arms and blades for this motor, we suggest **A17529A** or **A17529CHP** Arms (below) and **A17528** or **A17528B** Blades - (Page Sedan 29).

A17508E6 6 Volt - 3 1/4" Shaft Price Ea. \$ 41.25

A17508E12 12 Volt - 3 1/4" Shaft Price Ea. \$ 52.75

Electric Wiper Assembly

This is a polished stainless steel assembly **complete with arm and blade.** Really nice. Instructions are included for shortening shaft if required.



A17508SS6 28-31 6 Volt - 5" Shaft - No On-Off Switch Price Ea. \$ 55.00

A17508SS12 28-31 12 Volt - 5" shaft - No On-Off Switch Price Ea. \$ 54.95

Electric Wiper Connection

These connections are used on all the electric wipers to connect the wire to the wiper motor.



A17675 28-30 Price Ea. \$ 5.50

Electric Wiper Wire Kit

Replace your dirty, cracked wiper wire with this correct black and blue cloth-covered wire. It runs from the terminal box to the wiper motor and has the flag connector for the terminal box end.



A17500WK 28-31 Price Ea. \$ 3.75

Electric Wiper Wire Clip

You will need three of these to hold the wiper motor wire to the header on your Sedan.



A17616A 28-30 Price Ea. \$ 1.50

Wiper & Dome Light Wire Support

This clip was held in place by a bolt that held the gas tank to the cowl. It served as a grommet holder for the wiper and or dome lamp wire, and the other part of the clip held the top of the kick panel in place. Grommet included. 2 Required.



A14591 28-29 Price Ea. \$ 4.30

A14591GR Grommet Only Price Ea. \$ 0.70

Sedan Electric Wiper Wire Supports

You will need three of these for the Sedan to hold the wire which goes to the wiper motor plus to support the cowl light wire. Need 3 per Car.

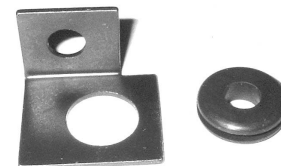

A14593A 28-29 Price Ea. \$ 2.25

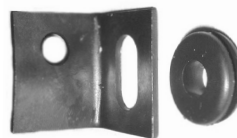

A14593 30-31 Price Ea. \$ 2.90

***** MIKES TIPS *****

Use only Replacement Blades with Replacement Arms and Show Blades with Show Arms.

Replacement Electric Wiper Arm

If your wiper motor is mounted on the outside of the cab, this is the arm to use, except 1931 Slant Windshield Sedans. Originally used Black in 1929 - 1931.



A17529A 28-31 Price Ea. \$ 3.75

Replacement Electric Wiper Arm (Generic)

If you've got the aftermarket **A17500-E6** motor, you will need this wiper arm. You can use the **A17528** or **A17528B** blade. This is a chopped (shorter) Arm also for Street rods.



A17529CHP 28-31 Price Ea. \$ 10.95

Mike's "A" FORD-ABLE Parts

Replacement Electric Wiper Blade

These wiper blades fit all Model A Replacement arms.



A17528 28-29 7-1/4" Blade
Price Ea. \$ 2.50

A17528B 30-31 8-1/4" Blade
Price Ea. \$ 2.75

Show Quality Electric Blades

8 3/4" Nickel Plated, Single Ply Blade with Cotter Pin Hole used on Early 1928 Closed Cars. Use A17565A Arm.



A17506A Early 1928 Price Ea. \$ 16.50

This is an exact duplicate of the original TRICO embossed blade for the cars with the original electric motor. 8 1/4" Nickel Blade with cotter hole - single ply rubber. Use A17565A Arm.



A17506B 1928 - April 1929 - Closed Cars
Price Ea. \$ 16.25

8 1/4" Nickel Plated, Contoured Top, Multi-Ply Blade with Cotter Pin Hole. Use A17565A Arm.



A17506D April 1929 - June 1930
Price Ea. \$ 16.50

8 1/4" Black, Multi Ply, Universal Use Blade with Cotter Pin Hole. Use A17565A Arm.



A17506E Price Ea. \$ 16.50

Show Electric (Flat) Tension Arm

This exact reproduction arm has been heat treated and cadmium plated. Includes the Special Square Head Tension Bolt, Knurled Nut and Cotter Pin. Not Stamped with Trico - 6 1/2" Cad.



A17565A 1928 - June 1929 Price Ea. \$ 21.95

Wiper Mounting Boots

These rubber boots slipped onto the mounting ears of the original electric wiper motors.



A17595AR 1928 Closed end
Price Ea. \$ 6.95

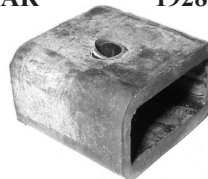

A17595B 28-30 Open End
Price Ea. \$ 2.85

Wiper Boot Plates

This plate goes on top of the wiper mounting boot on the later closed cars.

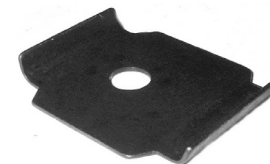

A17595P 29-30 Price Pair \$ 3.40

Wiper Motor Felt

This felt fits most motors in use today. It goes between wiper motor and the windshield frame on all closed cars. 3"x 5/8.

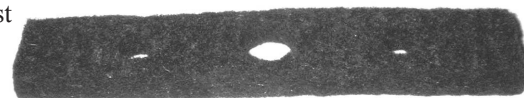

A17618 28-30 Price Ea. \$ 1.75

Manifold Hole Plug

This is the special slotted pipe plug which was used on the side of the block near the oil pump to let you see if your oil pump was working. This is also used for the valve fitting on the inlet manifold to plug the hole. To hold in the oil pump while changing the pan gaskets - use A6701 Page Gen. 118. This is also used to plug the intake manifold when an electric wiper is used.



A6621 28-31 Price Ea. \$ 0.65

Electric and Vacuum Tandem Wiper Kit

This kit allows you to add on a wiper for the passenger side so they can see, too! It will adapt to A17508 6V or 12 V Motor. Before drilling any holes, make sure the distance between the Motor Shaft and the Pivot Shaft is EQUAL to the length of the Link Rod Assembled to the Wiper Arm.



A17574 28-31 Price Set \$ 29.15

There are not any decent New Vacuum Wiper Motors available. We can rebuild a good core.

Vacuum Wiper Motor Control

This is the on/off control for outside mounted wiper motor. This passes through windshield frame.



334 28-31 Price Ea. \$ 3.95

Vacuum Wiper Mounting Screws

These are the screws needed to mount the vacuum wiper motor.



500CMB 30-31 Closed car Price Pair. \$ 1.10

Low Quality Vacuum Arm

8" Black, Clip Type Arm used from June 1929 thru 1931 on Standard Sedans.



565B 29-31 Price Ea. \$ 16.00

Low Quality Vacuum Arm

8" Black, Clip Type Arm used from April 1931 for the Standard Slant Windshield Fordors.



565D 1931 Price Ea. \$ 16.00

Low Quality Vacuum Arm

8" Chrome, Clip Type Arm used in 1931 for Deluxe Slant Windshield Fordors.



565E 30-31 Price Ea. \$ 16.00

Low Quality Vacuum Blades

8" Black, Single Rivet, Multi-Ply Blade with Clip for April thru 1931 Closed Cars and 1931 Slant Windshield Fordors.



506F 1929 - 1931 Price Ea. \$ 16.50

Show Quality Vacuum Wiper Blade

8 1/4" Black, Two Rivet, Multiply Blade with Clip for 1931 Standard Closed Cars.



A17506H 1931 Price Ea. \$ 16.50

Show Quality Vacuum Wiper Blade

8 1/4" Chrome, Two Rivet, Multi-Ply Blade with Clip for 1931 Deluxe Closed Cars.



A17506I 1931 Price Ea. \$ 16.50

Closed Car Blade Arm Support

These are the same design but the '28 model is shorter.



A17564A 1928 Nickel Plated Price Ea. \$ 26.00



A17564B 29-30 Nickel Plated Price Ea. \$ 26.00

Closed Car Manual Control Lever

This is a plated control lever.



A17575 28-30 Nickel Plated Price Ea. \$ 28.90

A17575B 28-30 Black Price Ea. \$ 27.50

Closed Car On-Off Lever

This is a plated on/off lever for the closed car.



A17580 28-30 Nickel Plated Price Ea. \$ 26.00

Trico Vacuum Wiper Bowl Gaskets

If you need only the bowl gaskets for your Trico motor, Mike's got them.



A17508G 29-31 Price Pair \$ 2.35

Mike's "A" FORD-ABLE Parts

Trico Vacuum Wiper Motor Tag

If your Trico embossed tag has been painted or marred, replace it with this new one.



A17508T Price Ea. \$ 3.50

Chrome Vacuum Wiper Knob

Replace your worn knob with this new one.



A17513 28-31 Price Ea. \$ 1.75

Trico Vacuum Wiper Knob

If you want the knob with "TRICO" on it, this chrome-plated knob is for you.



A17513D 29-31 Price Ea. \$ 3.50

Wiper Shaft Nut (Inside Mounted Wipers)

For the Slant Windshield Sedans, Mike has this special nut to hold the vacuum windshield wiper in place.



A17502 Late 1931 Price Ea. \$ 1.25

Vacuum Wiper Hose

Six feet of the small diameter hose for the wiper. Rubber. Used on all cabs with wipers.



A17520 28-31 6 Ft. Price Ea. \$ 2.25

Fabric Vacuum Wiper Hose

For the show car, Mike has this simulated fabric covered wiper hose. Used on all cabs with wipers.



A17520OR 30-31 Price Ea. \$ 6.00

Vacuum Wiper Hose Header Clips

This set of three clips hold the wiper hose in place under the windshield hinge on the Sedan. The hinge screws also secure these clips. Sold as a set of three.



A17616 30-31 Price Set/3 \$ 2.95

Manifold Vacuum Line Connector

This is the brass connector that screws into the intake manifold that you connect the vacuum line to.



Manifold Hole size - 1/8 - 27 Pipe Thread.

A17540 29-31 Price Ea. \$ 1.10

Manifold Vacuum Line

Mike has the steel vacuum line with brass fittings included. This goes from the intake manifold up to the firewall.



A17543A 28-31 Price Ea. \$ 3.45

Manifold Vacuum Line Fittings

These are new quality vacuum line fittings. These are included with a new Manifold Vacuum Line A17543A or A17522.



A17543F 28-31 Price Ea. \$ 0.45

Firewall Vacuum Line Connector

This is the double female brass connector that attaches to the firewall for both inside and outside vacuum lines to connect.



Includes 1/2-20 Cad. Nut.

A17541 29-31 Price Set \$ 3.25

Inside Vacuum Line (Brass Fittings Included)

This is the steel vacuum line that goes from the firewall under the gas tank and up the stanchion on Sedans.



A17522 29-31 36" long Price Ea. \$ 4.10

Mike's "A" FORD-ABLE Parts

Sedan Top Parts

Sedan Top Kits

These kits are complete with the top decking padding, and everything else you'll need excluding chicken wire. Instructions Included.

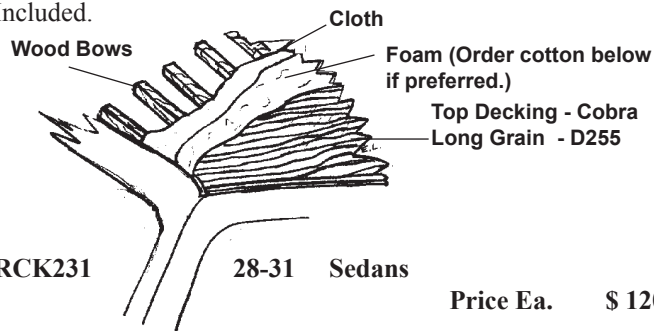

RCK231 28-31 Sedans Price Ea. \$ 120.00

Sedan Top Decking - Cobra Long Grain

Tops do wear out so Mike has this long-grain cobra top decking. It's 64" wide; the Sedans need 8 ft. Sold by the foot.

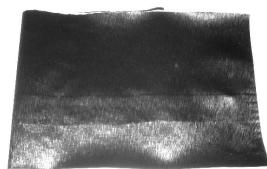

D255 28-31 Top Decking 64" wide Price/Ft. \$ 6.95

Sedan Cotton Padding

This is the cotton padding that goes under the top decking. The padding is 40" wide.



A38250BR 28-31 Sedan Roll - 7 Foot Price Ea. \$ 11.75

Top Corner Wood

These shaped pieces of wood go into the rear corners of a Tudor Sedan.

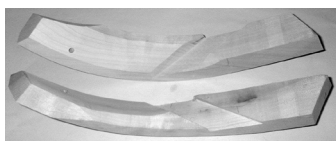

AWD1027-6 28-31 Price Pair \$ 60.00

Rear Corner Wood Reinforcement Bracket

This plate fits on the rear corner wood on a Murray or Briggs Fordor Town Sedan. It is reversible, left or right. Use it to strengthen old wood.



RAR250 1928 - Early '31 Price Each \$ 10.95

Curved Roof Panels (Front) - Tudor & Pickup

This panel goes above the door to the rib rail. You will have to drill holes to mount the panel and rain gutters.

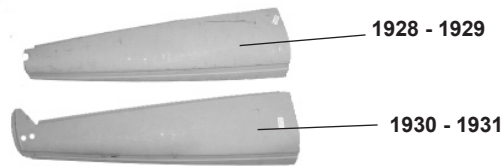

A47775L	28-29	Tudor Left	Price Ea.	\$ 96.00
A47775R	28-29	Tudor Right	Price Ea.	\$ 96.00
A47776L	30-31	Tudor Left	Price Ea.	\$ 125.00
A47776R	30-31	Tudor Right	Price Ea.	\$ 125.00

Curved Roof Panels (Rear) - Tudors Only

This has the roof rib ledge on the inside. It extends approx. 1" beyond the rear roof molding groove, and 1 1/2" below the rain gutter.



A47774L	28-31	Left	Price Ea.	\$ 215.00
A47774R	28-31	Right	Price Ea.	\$ 215.00

See Page Sedan 6 for Header Cover and Page Sedan 6 for Filler Trim

PLEASE NOTE: MOLDING AND GUTTERS ARE SHIPPED IN PVC TUBING. UPS DOES CHARGE AN ADDITIONAL HANDLING FEE.

***** Mike's Hints *****

Forming Rain Gutters - (A47301)

Trace gutter curve on the body to a piece of paper. Copy the curve to a 2" x 10" block of wood. Cut radius out of block with a jig saw. Nail a larger sheet of plywood to the 2" x 10" block. The "J" gutter is extra long, therefore place one hand at the end of the "J" molding and the other hand about 2 1/2 feet apart. You can waste the 6" - 8" where your hand is located. Slide the gutter across the plywood and pull it against the block to form the curve. The flat tacking strip should be cut half way across every 1/2 inch to be able to bend along the curve.

Mike's "A" FORD-ABLE Parts

Sedan Rain Gutters - Full Set

One set (90") will do both sides with this aluminum gutter that you bend to the contours of your car. Fasten the flat piece to the roof and the gutter piece snaps into it. Will work on any car with wood to nail it to. See hints for forming. Due to the length of gutters, they are shipped at OS2 70 Lbs rate and additional shipping will be charged.

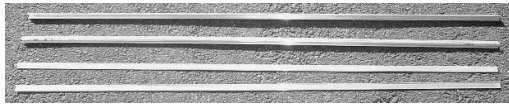

A47301 28-31 sent UPS in PVC tubing
Price Set/4 \$ 24.00

***** Mike's Hints *****

Instructions on Aluminium Top Moulding

Nail the molding to the roof, then tap the edges in to hide the nails. A "V" shaped block of wood, will do the trick.

Top Roof Molding - Style # 1

This style of aluminum molding goes on the front over the sun visor for the following cars: '29-'31 Tudor Sedan 155 A,B,C,D '29-'31 Fordor Sedan 165 A,B,C,D, '29-'31 Fordor Sedan 170 A & B.



A473011 5 Ft. Piece 5/8" wide
Price Ea. \$ 12.60

Top Roof Molding - Style # 2

This style of aluminum molding goes on the front over the sun visor for the following cars: '30-'31 Tudor 55B.



A473012 5 Ft. Piece 1/2" wide
Price Ea. \$ 12.60

Top Roof Molding - Style # 3

This style of aluminum molding goes on the rear and sides of the following cars: '29-'31 Town Sedan 155ABCD, Fordor Sedan 165 ABCD, '29-'31 Fordor Sedan 170 AB, Briggs Fordor needs 2 strips per car.



A473013 10 Ft. Piece 5/8" wide
Price Ea. \$ 18.60

Top Roof Molding - Style # 4

This is the style of molding used on the front of the '31 Slant Windshield Fordor Sedans. Fits 160ABC Slant Windshield Sedans.



A473014 1931 5 Ft. Piece 3/4" wide
Price Ea. \$ 12.40

Top Roof Molding - Style # 6

This is an aluminum molding which is nailed in the center and then rubber molding (A473019) is inserted into it to cover the nails. Used on the '31 Sedans (160-A,B,C). 6' Long, order 3 for Sedans.



A473016 30-31 Price Ea. \$ 19.50

Top Roof Molding - Rubber Insert - Style # 9

This is the rubber insert for A473016. This is a 19 feet long, 3/16" wide, half round rubber molding.



A473019 30-31 Price Roll \$ 9.50

Top Roof Front Molding - Style # 8

This is the two-piece steel molding that goes over the sun visor 28-'29 Tudor 55A. Nail the tac strip down and snap the molding onto it. Can be used on front and rear.



A473018 28-29 6 feet long - need 2 pieces
Price Set/2 \$ 18.45

Welting (Wire Welt) - Crown Vinyl Molding

This half round welt (wire welt) is often used in place of the metal roof molding. You nail it down and fold it over to form a nice fabric bead. Measure carefully as scraps cannot be returned. Comes per foot.



A47304 28-31 Price/Ft. \$ 0.90

Split Welting (Hid'em)

This split welting can be used with most models with a wood top.



A47305 28-31 Black Price/Ft. \$ 0.65
A47305T 28-31 Tan Price/Ft. \$ 0.80

Mike's "A" FORD-ABLE Parts

Hid'em Welt End Tip

This nickel-finished tip (with nail) is used to complete the trim when using the hide'em welting (above).



A47303A 28-31 Price Ea. \$ 1.25

Front Gutter Clips

This style drip rail tip goes on the front drip rail moldings on the '28-'29 Briggs Fordor only.



A47303C 28-29 Price Pair \$ 5.00

Front Gutter Clips

This style drip rail tip goes on the front drip rail moldings on the '28-'29 Tudors.

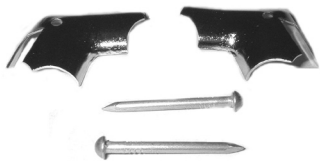

A47303D 28-29 Price Pair \$ 5.00

Rear Gutter Clips

This type of drip rail clip was used on the rear drip rail moldings on the '28-'29 Briggs Fordor only.



A47303F 28-29 Price Pair \$ 5.00

Rear Gutter Clips

This style tip goes on the rear of the drip rail moldings on all Tudor Sedans.

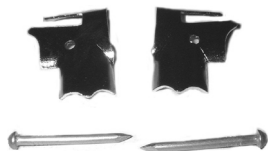

A47303G 28-31 Rear - Tudor Sedans
Price Pair \$ 5.00

Roof Tacks

This is a set of 100 tacks used to tack the black vinyl decking to the wood top frame.

The top molding covers these tacks.



A38425MBR 28-31 Price Pack \$ 2.25

Body Nails

Commonly used on all Model "A's".



Nail Style #3

.074 diam. x 3/4" long - oval head - pack of 100

Price Pack \$ 1.50

Top Mouldings & Rain Gutters

Nail Style #4

.085 x 7/8" long - pack of 100

Price Pack \$ 1.50

Use these where rusting could occur - Stainless Steel

Nail Style #5

.085 x 3/4" long - pack of 100

Price Pack \$ 3.00

1931 Slant Windshield Fordor belongs to Mr. F. Akers.



WINDOW SHADES & ASSIST STRAPS

Assist Straps for Tudors and Fordor Sedans

If you need to replace your assist straps, these are really nice. Available in grey, green, taupe and tan to match your interior. Brackets and screws Included.



RFP105GRE	28-31	Green	Price Pair	\$ 58.95
RFP105GRY	28-31	Grey	Price Pair	\$ 58.95
RFP105TAN	28-31	Tan	Price Pair	\$ 58.95
RFP105TPE	28-31	Taupe	Price Pair	\$ 58.95

Assist Straps for Slant Windshield Fordors

Brackets and screws Included.

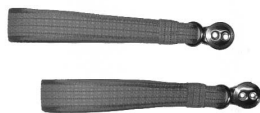

RFP105VGRE	30-31	Green	Price Pair	\$ 62.00
RFP105VGRY	30-31	Gray	Price Pair	\$ 62.00
RFP105VTAN	30-31	Tan	Price Pair	\$ 62.00
RFP105VTPE	30-31	Taupe	Price Pair	\$ 62.00

Assist Strap Brackets

Mike also has these new brackets for the assist strap. The horizontal was used on '28-'31 Deluxe Fordors and the vertical was used on the late '31s.



RFP105B	28-31	Tudor & Fordor Sedans	Price Pair	\$ 8.00
RFP105VB	30-31	Slant Windshield Fordors	Price Pair	\$ 8.50

Robe Cord & Brackets

A set of new robe cord for your Model "A". Coachlace Braid with 1/2" Nylon Cord Core. Brackets are Included.

RFP600HWGRE	Green			
RFP600HWGRY	Grey			
RFP600HWTAN	Tan			
RFP600HWTPE	Taupe	29-31	Price Set	\$ 87.50



Robe Cord Brackets

Replace your brackets with these chrome plated brass brackets with mounting screws.

Not suitable for Slant Windshields. For Town Sedans and Deluxe Fordors.



HW114	28-31		Price Pair	\$ 11.95
-------	-------	--	------------	----------

Window Shade Brackets

These chrome brackets are used to mount your window shades.



A48301	28-31	Price Pair	\$ 15.75
--------	-------	------------	----------

Window Shades

Mike has a variety of shades available for the Model A Closed Car. Tan in color, they are ready to mount on your brackets. Quarter window.

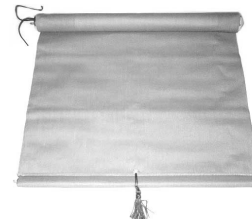

A4830012	Murray town sedan quar. window . 12-1/4"	Price Ea.	\$ 25.75
A4830014	Briggs town sedan quar. window. 14"	Price Ea.	\$ 25.75
A4830024	Tudor & Sedan rear windpw .24"	Price Ea.	\$ 25.75

1930 Tudor owned by Mr. & Mrs. B. Bohanan, all dressed up ready for Kelly and Erich's Wedding. Two of Angie's children on the Running Board.



Mike's "A" FORD-ABLE Parts

Sedan Door Handles & Parts

Scroll Outside Door Handles

The **Fordors & Town Sedans**, used this style handle. All Scroll Handles are foreign made and are very good quality.



A702350C	28-29	R.Front/L.Rear	Price Ea.	\$ 25.50
A702351C	28-29	L.Front/R. Rear	Price Ea.	\$ 25.50
A702350D	30-31	R.Front/L. Rear	Price Ea.	\$ 25.50
A702351D	30-31	L. Front/R. Rear	Price Ea.	\$ 25.50

Scroll Locking Door Handle

This scroll-style locking handle was used on the **Fordor Sedans**. Keyed locks were used on the right side Only. Comes with 2 Keys.



A702350DL	30-31		Price Ea.	\$ 34.95
-----------	-------	--	-----------	----------

Locking Outside Door Handles

This chrome-plated locking handle was originally used only on the right-hand door but can be used on the left as well. Used on the **Tudors**. Comes with 2 Keys.



A702350AL	28-29		Price Ea.	\$ 34.00
A702350BL	30-31		Price Ea.	\$ 34.00

Outside Door Handles

This chrome-plated handle was used only on the left hand door but it can be used on the right as well. For the **Tudors**.



A702351A	28-29		Price Ea.	\$ 27.50
A702351B	30-31		Price Ea.	\$ 24.95

Door Handle Screws

This is a set of four machine screws to attach the door handle.
4 X 10/32 X 11/16 Oval Head Screws.



A702780MB	28-31	Price Set/4	\$ 1.25
-----------	-------	-------------	---------

Wood Door Handle Screws

You'll need this kit if you have a **Fordor** or other car which takes wood screws to attach the outside handles. Enough screws for 2 doors - need 2 sets for **Fordors**.



A702780MBW	28-31	Price Set/4	\$ 1.50
------------	-------	-------------	---------

Door Handle Pads

These flat rubber pads go between your outside handle and the car to prevent scratches and rattles.



A702356B	28-29	Tudor	Price Pair	\$ 0.85
A702356C	28-29	Fordor	Price Set	\$ 0.90
A702356D	30-31	Tudor	Price Pair	\$ 1.00
A702356F	30-31	Fordor	Price Set/4	\$ 1.60

Door Handle Cup And Spring

You'll need one set per handle of this special cup washer and spring. The spring is crimped onto the outside door handles under the escutcheon. Not needed when purchasing new handles. Works best on original handles.



2 Piece Set - contains 1 spring & 1 cup.

A702350R	28-31	Price Set/2	\$ 1.55
----------	-------	-------------	---------

Door Lock Cylinder

If you have a separate lock cylinder under a regular door handle, you will use this.

Comes with 2 keys.



A702350L	28-31	Price Ea.	\$ 12.40
----------	-------	-----------	----------

Mike's "A" FORD-ABLE Parts

Sliding Door Lock

This is the inside door lock that goes on the left hand door of the Tudors.



A46168 28-31

Price Ea. \$ 4.95

Sliding Door Lock Screws

This is a set of the small flat-head machine screws you'll need to attach the A46168 slide lock.

2 x 10/32 x 1/2"



A46168MB 28-31

Price Pair \$ 0.95

Lock Knob

This 10/32" threaded lock knob screws onto the stud of the slide door lock (A46168) on: '28-'31 Tudors



A46192A 28-31

Price Ea. \$ 2.95

Standard Slide Lock Escutcheon

This standard escutcheon for the slide lock is made just like the original. Includes a large washer. Used on: 1928 - May 1930 Tudors.



A46272AR 28-30

Price Ea. \$ 5.75

Deluxe Slide Lock Escutcheon

This is the escutcheon for the slide style inside lock on the left-hand door. Includes a large washer. 1928 - Early 1931 Fordors After March 1930 - Tudor



A46272 28-31

Price Ea. \$ 3.45

Lock Knob

Most Fordor Sedans used this twist style lock knob. 1928 - 31 Fordors 1929 - 31 Town Sedan 6/32 x 1/2"



A46192B 28-31 need 3

Price Ea. \$ 4.65

Door Lock Arms - Fordors

This is the lock arm, that is usually missing or broken. It is located on the backside of all lock levers on Fordors.



RAR256 28-31

Price Ea. \$ 3.95

Latch Lock Studs

These studs fit Town Sedans 1928 - mid '31 and all Fordor Sedans. They fit into the lock lever mounts RAR256. Need 3 per car.



RAR259 28 - Mid. 31

Price Ea. \$ 26.95

Sleeve Nut & Washer A702400SN

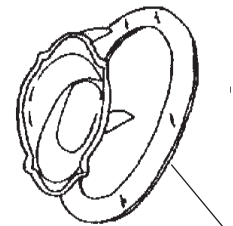
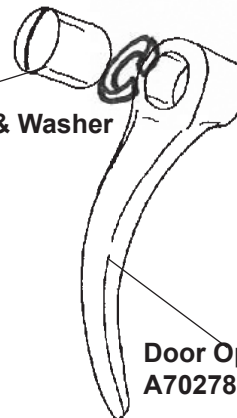

Escutcheon and Ring A46270 or A46270AR

Door Opener A702780 or A702400A

Inside Door Handles - Plain (Lift up Style)

Made in the USA. This authentic reproduction was used on: '28-'31 Tudor Sedans,



Order A46270AR Escutcheon. Order A702400SN Sleeve Nuts

A702780AOR	28-31	Chrome	Price Ea.	\$ 6.95
A702780NOR	28-31	Nickel	Price Ea.	\$ 6.95

Standard Inside Door Handle Escutcheon

Made in the USA. This standard escutcheon for the inside door handles A702780AOR or NOR is made just like the original. Includes Washer. Used on: 1928 - May '30 Tudors



A46270AR 28-31

Price Ea. \$ 6.75

Door Handle Sleeve Nuts

These threaded sleeve nuts were used to hold the lift up style door handles on the shaft. 1 x 5/16 - 24 Nut & l/w.



A702400SN 28-31

Price Ea. \$ 1.45

Mike's "A" FORD-ABLE Parts

Inside Door Handle (Twist Style)

This is the "twist" style inside door handle used on:

1931 Slant Windshield Town Sedan
1931 Slant Windshield Deluxe Fordor



Order A48139C Escutcheon.

Order A46250P to secure.

B702400C 30-31 Price Ea. \$ 10.20

Twist Style Door & Window Handle Escutcheon

A plain round escutcheon with a grooved ring, used with B702400C.

It was also used for the window riser handles on those cars.

Chrome 1-3/8" diam. x 1/2".

1931 Slant Windshield Town Sedan
1931 Slant Windshield Deluxe Fordor



A48139C 28-31 Price Ea. \$ 4.80

Door & Window Riser Pins

A set of four pins, 1/8" diam. x 5/8" long, for the inside window Riser.



A46250P Price Set/4 \$ 0.65

Inside Door Handle (Lift up Style)

The Triangle (A702400B) chrome plated lift-up style inside door handle was used on:

'28-'31 Briggs Fordors
1929 Town Sedan



The Square (A702400A) chrome plated lift-up style inside door handle was used on:

'30-'31 Tudors
'29-'31 Town Sedan
'29-'31 Murray Fordor
'30-'31 Briggs Fordor



Order A702400SN Sleeve Nut.

Order A46270 Escutcheon.

A702400A 28-31 Square Top Price Ea. \$ 8.45

A702400B 28-31 Triangle Top Price Ea. \$ 8.45

Deluxe Inside Door Handle Escutcheon

This is a deluxe style inside door handle escutcheon.

Includes washer. Used on:

1928 - Early 1931 Fordors
March '30 - 31 Tudor



A46270 Price Ea. \$ 3.75

Door Pull Handle

This door pull handle comes complete with hardware to attach to the window molding on the Fordors to help close the door.



A61062CR 29-31 Price Ea. \$ 8.65

Standard Window Riser - A702780A

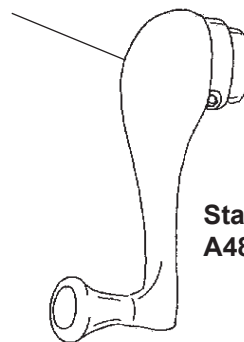

Standard Escutcheon A48139AR



Deluxe Escutcheon A48139B

Window Riser (Plain)

This is the standard chrome-plated window riser used on:

1928 - 1930 Tudors

Order A48139AR Escutcheon.



A702780A May 28 - May 30 Price Ea. \$ 8.75

Standard Window Riser Escutcheon

This is the standard escutcheon which fits between the window riser handle and the upholstery.

1-5/8" diam. x 5/8" high.

Used on:

1928 - 1930 Tudors



A48139AR 28-30 Price Ea. \$ 2.95

Mike's "A" FORD-ABLE Parts

Window Riser (Scroll Type)

The deluxe closed cars used this scroll window riser used on:

1928 - 1931 Fordors

March 1930 - 31 Tudor

1931 Standard Slant Windshield Fordor

Order the A46250P to secure the handle.

Order A48139B Escutcheon.

A702780B 28-31 Price Ea. \$ 9.35



Spring Loaded Window Riser Escutcheon

A replacement style that can be used in place of the A48139AR or the A48139B Escutcheons.

Brushed chrome finish. I.S. is 11/16". Can be collapsed to a thickness of 15/32" or out as much as 5/8".



A48139RE 28-31 Price Ea. \$ 4.00

Deluxe Window Riser Escutcheon

This is a chrome plated deluxe style escutcheon which fits between the window riser handle and the upholstery.

Used on:

1928 - Early '31 Fordors

March '30 - 31 Tudor

A48139B 28-31 Price Ea. \$ 2.95



Window Riser (Deluxe)

This style window riser was used on:

1931 Slant Windshield Town Sedan

1931 Slant Windshield Deluxe Fordor

Order A46250P to secure the handle.

Order the A48139C Escutcheon.

A702780C 30-31 Price Ea. \$ 9.35



Escutcheon Spring

This cone-shaped spring fits behind the upholstery panel against the escutcheons to keep everything tight.



A48284 28-31 Price Ea. \$ 0.75

Quarter Window Handle

The Slant Windshield Fordor Sedans with the quarter windows that go up and down both used the "T" handle.

Includes a Pan Head Screw.

Order A48139C Escutcheon.

A164272BRC 30-31 Price Ea. \$ 10.00



Upholstery Clip

These clips are made to hold the upholstery to the door on the Tudors.



A46126 28-31 Price Set/10 \$ 2.50

Upper Door Seal

This is an aluminum channel with rubber insert that fits under the garnish moldings. The rubber rests against the window glass to maintain a seal as it goes up and down.



A19008A 28-31 Tudor Price Pair \$ 8.50

A19008C 28-31 Tudor (Rear) Price Pair \$ 8.50

Rubber Insert for Upper Door Seal

If you are only needing to replace the insert in your channel, this will do the job. Used on:

'28-'31 Tudor



A19008R 28-31 Price Ea. \$ 2.80

Front Door Weather Seal and Retainer

Attach this metal channel with rubber strip installed to the wooden door frame at the bottom of the window opening to help keep rain and dirt from going inside of your door. 23" Long - Need 2.

Used on:



'28-'29 Fordor 60 A, B & C

'28-'29 Town Car 140A

'29-'31 Briggs Town Sedan Fordor 155B & D

'29-'31 Briggs Std. Fordor 165B, D & 170A & B

A48162 28-31 Price Ea. \$ 13.50

Rear Door Weather Seal and Retainer

Attach this metal channel with rubber strip installed to the wooded door frame at the bottom of the window opening to help keep rain and dirt from going inside of you door. 21 1/8" Long - Need 2.

Used on:



'28-'29 Fordor 60A, B & C

'28-'29 Town Car 140A

'29-'31 Briggs Town Sedan Fordor 155B & D

'29-'31 Briggs Std. Fordor 165B & D and 170A & B

A48163 28-31 Price Ea. \$ 13.50

Mike's "A" FORD-ABLE Parts

Header Strips

Mike has these pairs of header strips which screw into the frame above the door.



A45890A 28-31 Tudors Price Pair \$ 26.25

Header Strip Screws

This set has enough screws to attach the pair of header strips on your car or pickup. No. 8 - 1" Oval Head Wood Screws.



A45890MB 28-31 Price Set/12 \$ 1.25

Bottom Door Seal

This rubber seal goes on the bottom of the door and is held in place by the same clips that hold the door panel on. You will need 2 Rolls for a Fordor.



A19009 28-31 Price Roll \$ 6.25

Door Top Cover Plate Screws

This 6 piece set of screws holds the top cover plate to the top of the door. 6 x 10/32 x 3/8 Flat Head Screws.

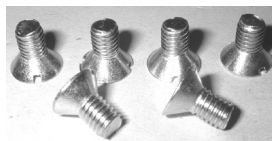

A45883MB 28-31 Price Set/6 \$ 1.10

Door Top Cover Plate

This stamped steel plate covers the top of the door where the side glass stops.



A45883A 28-31 Tudor Price Ea. \$ 39.95

Tube Nuts

#6-32". You'll need three tube nuts per door to mount the window garnish molding on the Briggs Straight Windshield Sedans.



These are included in the trim kits. A45484 Set of 6 Price Set \$ 3.55

#8-32". You'll need ten of these tube nuts per door to mount the window garnish molding on the Slant Windshield Sedans. These are included in the trim kits.



A45483T Set of 10 Price Set \$ 4.50

Door Hinge To Door Screws

This set of nine screws is needed to attach the door hinge to the door. 9 x 5/16-24 x 1/2".



#109 28-31 Price Set/9 \$ 2.45

Door Hinge To Body Post Screws

This set of three screws is needed to attach the door hinge to the body. 6 Piece Set. 3 Screws and 3 Washers.



#109B 28-31 Price Set/6 \$ 1.75

Washers Only

A special countersunk washer used when mounting the floorboards. These washers are also used on some of the door hinges.



#109W 28-31 Price Ea. \$ 0.12

Hinge Pin Remover

This helpful tool, uses three graduating hardened push pins to push your old hinge pins up and out of the hinge. As you tighten the bolt it will push the dowel and the old pin out. Set comes complete with 3 different length push pins and complete instructions. NOT to be used on Slant Windshield Cars. This item is NOT Refundable!!

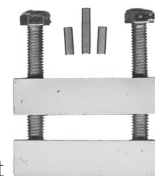

T46335HR 28-31 Price Ea. \$ 28.75

WARNING!!!

If your dowel pins start bending DO NOT go any further with this tool. These dowels are made from a hardened steel but NOT case hardened. The manufacturer has issued a warning that if a case hardened or heat treated steel was used, it could very well explode or splinter under such pressure, and possibly do bodily harm. I suggest trying penetrating oil, but if that doesn't work, then take a fine drill bit and try drilling at least halfway through the pin. Then use the removing tool.

Mike's "A" FORD-ABLE Parts

Closed Car Door Hinges

The hinge pin holes are drilled, but the body mounting holes are **NOT** drilled. Unfinished Cast Bronze.

Used on:

'28 - '31 Tudor

30 x 31

28 x 29



Lower

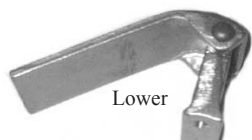

Lower

Middle



Middle



Upper



Upper

A46300AL	28-29	Lower Hinge	Price Ea.	\$ 70.00
A46300AM	28-29	Middle Hinge	Price Ea.	\$ 70.00
A46300AU	28-29	Upper Hinge	Price Ea.	\$ 70.00
A46300L	30-31	Lower Hinge 1 3/4" h x 4 1/4"	Price Ea.	\$ 70.00
A46300M	30-31	Middle Hinge 1 3/4" h x 3 3/8"	Price Ea.	\$ 70.00
A46300U	30-31	Upper Hinge 1 3/4" h x 2 3/8" w	Price Ea.	\$ 70.00

Closed Car Door Hinge Pins

These round headed hinge pins are authentic for the Sedans.



Not for the Slant Windshield - Use A45335B

A46335	28-31	Standard - .233 / .236	Price Ea.	\$ 0.45
A46335OS	28-31	Oversized - .247 / .250	Price Ea.	\$ 0.45

Closed Car Stainless Door Hinge Pin

This stainless steel hinge pin is knurled with a polished head. They fit the Tudors.



A46335SS	28-31	Price Ea.	\$ 2.55
----------	-------	-----------	---------

Slant Windshield Hinges - Hinge to Cowl

These cast bronze hinges are for the **Slant Windshield**. Only the hinge pin hole has been machined. You will need to drill and tap the mounting holes.

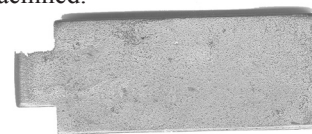

A46300SWC	1931	Price Ea.	\$ 50.00
-----------	------	-----------	----------

Slant Windshield Hinges - Hinge to Door

These cast bronze hinges are for the **Slant Windshield**. Only the hinge pin hole has been machined. You will need to drill and tap the mounting holes.



A46300SWD	1931	Price Ea.	\$ 69.00
-----------	------	-----------	----------

Door Hinge Pin (Slant Windshield)

If you've got the **Slant Windshield Fordor Sedan**, you'll need these authentic hinge pins.



A45335B	30-31	Price Ea.	\$ 0.90
---------	-------	-----------	---------

Female Dovetail Assembly

Mike has this complete dovetail assembly with the metal clip and rubber already in place. Used on:

All Fordor Sedans except the Slant Windshield Sedan.

Briggs Bodies



A61412A	28-31	Price Ea.	\$ 11.50
---------	-------	-----------	----------

Female Dovetail Rubber

The internal rubber in the A61412A Dovetail. 2 In each dovetail.



A156412BUM	28-31	Price Ea.	\$ 0.75
------------	-------	-----------	---------

Female Dovetail Assembly

For the **Slant Windshield** cars, Mike has this complete dovetail assembly. For '30 - '31 Fordors.



A61412C	1931	Price Ea.	\$ 37.50
---------	------	-----------	----------

Mike's "A" FORD-ABLE Parts

Dovetail Wedge And Spring

For the **Slant Windshield** cars. You will need two sets per dovetail. One Guide and spring per set.



A61413SW 1931 Price Set/2 \$ 5.60

6-Hole Male Dovetail

This chrome-plated 6-hole male dovetail was used on almost all **Fordor Sedans**.



A61419A 28-31 Price Ea. \$ 13.50

6 Hole Male Dovetail Screws

Nickel Plated Screws. Use these screws for A61419A. **6 x #8 x 1" Wood Screws.**



A61419MB 28-31 Price Set/6 \$ 0.50

Open and Closed Car Dovetail

This two-hole male dovetail was used on the **Tudors**. The female side for these will be in the Door bumper kits on page 314.

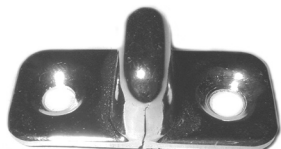

A76819A 28-31 Price Ea. \$ 3.75

Rear Door Dovetail

This two-hole male dovetail was used on the rear doors of the '31 **Slant Windshield Vehicles**. **Stainless Steel.**



A35577 1931 Price Ea. \$ 6.60

Slant Windshield Dovetail

This offset male dovetail was used on the front doors of the '31 **Slant Windshield Fordors**.



A76819BL 1931 Driver side Price Ea. \$ 13.50

A76819BR 1931 Passenger side Price Ea. \$ 13.50

Dovetail Screws

These machine screws hold the male dovetails in the door jams for all models.



A76819MB 28-31 Price Set/4 \$ 1.25

Door Bumpers

Mike has complete sets of the rubber, metal, and clips needed to change out the door bumpers for the following models.

The rubber may need trimming.

These are the best quality available.

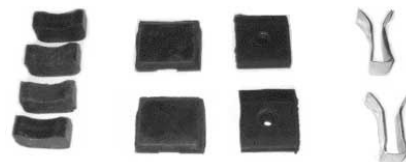

1928-1929 **Tudor** - 12 piece set.
A702610AS 28-29 Price Set \$ 11.25

1930-1931 **Tudor**. 16 piece set.
A702610BS 30-31 Price Set \$ 10.00

1928-1931 **Fordor**. 20 piece set
A702610CS 28-31 Price Set \$ 13.50

1931 **Slant Windshield Fordor**. 16 piece set.
A702610RS 1931 Price Set \$ 24.75

Door Bumper Clip

Spot Weld this three sided clip to the bottom of the door, 3 inches from the latch side, to hold the rubber door bumper in place. Uses one per door.



1928 - 1931 **Tudor Sedans**
A46457 28-31 Price Ea. \$ 4.25

Door Bumper Clip

Install this clip, in the same manner as above, but you will need two clips on each side of the door post.

Includes one #8 x 7/8" Flat head Wood Screw.

Uses 8 clips per **Fordor**.

1928 - Early 1931 **Fordor Sedan**
A46458 28-31 Price Ea. \$ 4.25



Door Bumper Dovetail Clip

This is the brass clip for the female dovetail on all '28-'29 **Tudors**.



A702610C 28-29 Price Ea. \$ 1.75

Latch Wood - Door Lock Cover

This is the latch wood that is mounted vertically about halfway up the door post. Originally this was made of hard rubber.

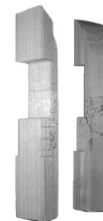

AWD1280-10 28-29 **Tudor**
AWD1281-10 30-31 **Tudor** Price Pair \$ 15.40

SEDAN

Mike's "A" FORD-ABLE Parts

Closed Car Door Latch

This excellent quality door latch fits the **Tudors**. The driver's side latch has the lock mechanism.



A46105AR	28-29	Passenger side	Price Ea.	\$ 22.50
A46106AL	28-29	Driver's side	Price Ea.	\$ 22.50
A46105BR	30-31	Passenger side	Price Ea.	\$ 22.50
A46106BL	30-31	Driver's side	Price Ea.	\$ 22.50

Closed Car Latch Screws

This set has enough screws to attach the door latches on both sides on the **Tudors**.



A46105MB	28-31	Price Set/8	\$ 1.10
-----------------	--------------	--------------------	----------------

Closed Car Latch Rivet

This special tubed rivet holds the flipper to the latch mechanism.



A46105RI	28-31	Price Ea.	\$ 0.55
-----------------	--------------	------------------	----------------

Closed Car Door Latch Spring Set

A spring set for that can be used on **Fordor** Latches.



A80055RK	28-30	Price Set	\$ 14.85
-----------------	--------------	------------------	-----------------

Closed Car Door Latch Spring Set

This set of springs has all the springs needed for both door latches for all 1928-1931 **Tudors**.

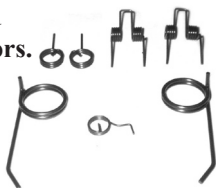

A46125	28-31	Price Set/7	\$ 6.60
---------------	--------------	--------------------	----------------

Fordor Latch Spring Rivets Only

The rivets sets only for the **Fordor** Latch Springs. These latches are for the 1928 - Early 1931's. **NOT** for S/W **Fordor**. One Set does one latch.



RAR248	Swiss Toledo Ohio Brand - Murray	Price Set/3	\$ 12.75
RAR249	Ferro Brand - Briggs	Price Each	\$ 6.00

Fordor Latch Spring Set

During the production of the Model A's there were two manufacturers of latches. Both of the companies stamped their name onto the latches, but suppliers could have been switched during production so double check which style that you have before ordering. Most Murray cars used "Swiss Toledo Ohio" and Briggs used "Ferro" Brand. The "Ferro" brand has a Diamond shaped logo. The sets are made up of 1 coil spring, 2 wire springs and rivets. These are **NOT** for S/W **Fordor**.

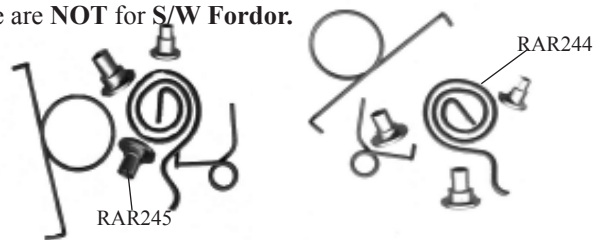

Swiss Toledo Ohio - Murray Fordor and Town Sedan
RAR244

Driver / Left Front Door & Passenger / Right Rear Door

RAR245
Passenger/ Right Front Door & Driver / Left Rear Door

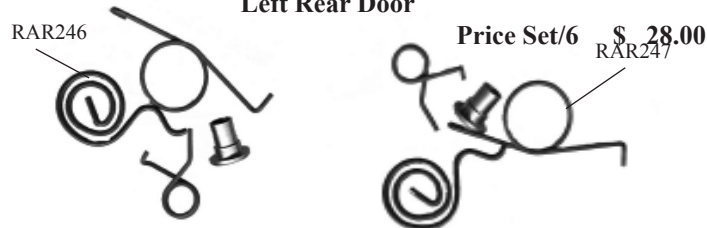

Ferro (Diamond) - Briggs Fordor and Town Sedan
RAR246

Driver / Left Front Door & Passenger / Right Rear Door

RAR247
Passenger / Right Front Door & Driver / Left Rear Door

Price Set/4 \$ 23.00

Closed Car Door Handle Spring

This style spring is used with the two style door opener.

160-A,B,C Slant Windshield Fordors.



A46125L	30-31	Price Ea.	\$ 6.00
----------------	--------------	------------------	----------------

Closed Car Striker Plate

This type of striker plate was used on **Tudors**.



A46137	28-31	Price Ea.	\$ 3.45
---------------	--------------	------------------	----------------

Striker Plate Mount Kit

There are enough screws here to attach the **A46137** strikers on one door.
1/4-20 x 1/2 Round Head Screws.



A46137MB	28-31	Price Set/4	\$ 0.75
-----------------	--------------	--------------------	----------------

Mike's "A" FORD-ABLE Parts

Striker For Slant Windshield

This two stage striker plate, including screws, was used on:

1931 Slant Windshield Fordor 160 A,B & C



A702340 29-31 Price Ea. \$ 8.70

Striker Plate Screws

The hardware to mount A702340.

Two #14 x 1 flat head wood screws and washers per set.



A48545 29-31 Price Set/4 \$ 0.40

Striker Nut Plate

This plate is used on the back side of the door post for the screws that anchor the striker plate thread into. Used on:

1931 Slant Windshield Fordor 160 A,B & C



RAR203 1931 Price Ea. \$ 10.00

Bezel

This bezel clamps onto the door panel where the panel is notched for the striker.



A48140 28-31 Price Pair \$ 2.50

Kick Panel Retaining Clip

These clips hold the bottom of the kick panel snug.

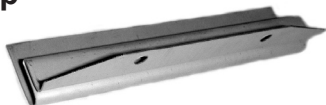

A40555CL 28-31 Price Pair \$ 5.75

Inside Door Latch Remote Rods

This is the rod that links the inside door handle to the door latch. Originals are almost always worn out or the threads are stripped. One kit does both doors. Kit includes the retainer plates, return spring and mounting screws.



A702401A 28-31 Tudor Price Set/12 \$ 33.00

Inside Door Opener Control Rod Mounting Plates

These are the plates that hold the inside door handle remote rods in place. The set includes 4 plates and 4 mounting screws.



A702403S 28-31 Tudor Price Set/8 \$ 11.55

Door Check Post Bumper

This pair will do both doors. The square rubber mounts in the door post for the door check bumper to butt against.

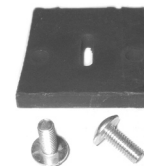

A702828BU 28-31 Price Pair \$ 3.95

Door Check Arm Brackets

Top and bottom brackets are spot welded to the door post to receive the arm (A702828CL). Order 1 set per door.

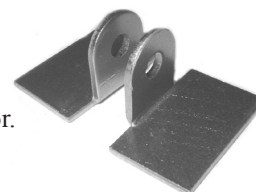

A702828BRKT 28-31 Price Set/2 \$ 4.90

Door Check Arm Brackets

Top and bottom brackets that screwed to the door post for the door check arms to attach to. Used on late 1928 thru 1931 Straight Windshield Fordors.

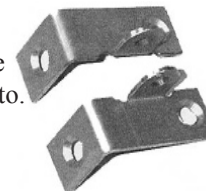

RAR231 28-31 Price Pair \$ 9.25

Door Check Arm And Rubber Bumper

This steel arm door check was used on all the Model A's that didn't have the rubber strap style footman's loop.



A702828CL 29-31 Front door on closed cars Price Pair \$ 6.15

Rear Door Arm (Fordor Sedans)

This is the same as above but the arm is bent a little sharper. Used on all Fordor Sedans EXCEPT Slant Windshield.



A702828CLI 30-31 Price Pair \$ 14.95

Door Check Bumper

This style of rubber bumper was used with the steel arm door checks. It attached inside the door.



A702828R 29-31 Price Pair \$ 2.05

Mike's "A" FORD-ABLE Parts

Closed Car Check Straps

This double loop door check strap is 6" long and was used on '28-'29 Tudors all with side mount spare tires.



A162592-6 Price Ea. \$ 3.65

This double loop door check strap is 8" long and was used on the '28-'29 Tudors without sidemount spare tires.

A162592-8 Price Ea. \$ 4.00

Closed Car Check Strap Bracket

Used with the rubber door check straps. Used on '28-'29 Closed Cars.



A162592L 28-31 Price Ea. \$ 1.15

Door Check Strap Bracket Screws

1928 - 29 Closed Cars Only. This is the set of screws needed to attach your door check strap. 12/24 x 3/4" Oval Head Machine Screw.



#48 28-29 Set of 8 Price Set/8 \$ 1.50

Closed Car Flat Strap

"T" Rubber door check Straps for '28 - '29 Leatherback, 1931 Slant Windshield and Fordor Sedans. 10 1/4" Long.



B162592L 30-31 Price Ea. \$ 5.50

Closed Car Check Strap Retainer Plate

Check Strap retainer plate used with B162592L.



B162592S 30-31 Price Ea. \$ 3.30

Windlace Rivets

This kit of tube-style rivets holds the windlace retainer in place on the '28-'29s. Use these to attach A45983CL to A45983. For window channel.



A46127 28-29 Price Set/20 \$ 2.40

Windlace Retainer

The '28-'29's used this steel strip to hold the windlace on the front of the door opening



A46128 28-29 Price Ea. \$ 18.25

Window Regulator

This good quality window regulator is the three-hole type used on the Tudors. Top quality!

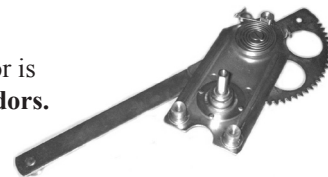

A48105A 28-31 Passenger Side Front & Drivers Side Rear

Price Ea. \$ 36.95

A48106A 28-31 Driver Side Front & Passenger Side Rear

Price Ea. \$ 36.95

Window Regulator

This window regulator is the four-hole type used on the Fordor Sedans.



A48105B 28-31 Passenger Side Front & Drivers Side Rear

Price Ea. \$ 40.65

A48106B 28-31 Driver Side Front & Passenger Side Rear

Price Ea. \$ 40.65

Window Regulator Bolts

This set of countersunk screws with star washers will attach the window regulators on both doors of the Tudors.

3 x 1/4 -20 x 5/8.

A48105MB 28-31 Price Set/6 \$ 1.50



Window Regulator Bolts - Fordor

One set does one regulator - 4 10-32 x 1/2 flat head screws, lock washers and square nuts. For Fordors Only.



A48111 28-31 Price Set/12 \$ 1.50

Window Regulator Spring

Mike also has this separate main spring of the window regulator in case that's all you need.



A48405/6 28-31 Price Ea. \$ 5.80

Mike's "A" FORD-ABLE Parts

1928 - 1931 Position of Window Felt Channels and Regulators

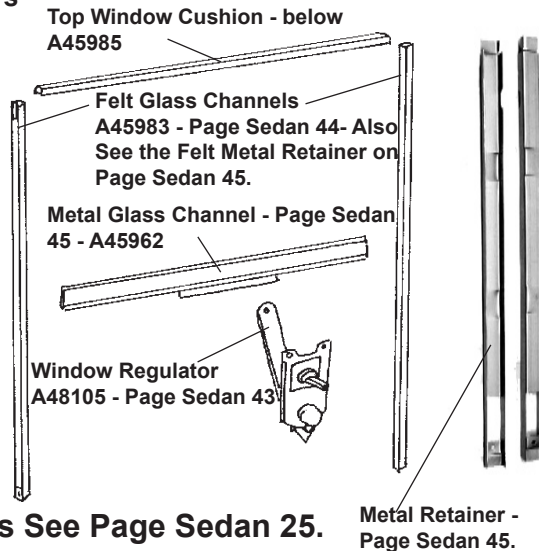

For Glass See Page Sedan 25.

Economy Window Channel Kit

Unassembled kit for you to put together yourself. One kit does one door ONLY. Kit contains: 2 - 32" felt channels, 1 - upper sponge rubber, 2 - upper clips, 2 - lower clips and 8 - rivets.



A45983S 28-31 Price Kit \$ 16.50

Front Door Window Channel Kits

These kits include all of the necessary moulded channels with clips attached, upper window sponge seals, "T" shaped anti-rattle rubber (when required), lower glass cushion bumpers and adhesive. One kit does both front doors.



A45983A	28-31 Tudor	Price Kit	\$ 49.50
A45983-4D	28-31 Fordor Sedan	Price Kit	\$ 49.50
A45983SWV	1931 Slant Windshield Fordor	Price Kit	\$ 60.50

Rear Door Window Channel Kits

These kits include all of the necessary moulded channels with clips attached, upper window sponge seals, "T" shaped anti-rattle rubber (when required), lower glass cushion bumpers and adhesive. One kit does both rear doors.



A56791A	28-31 Straight Windshield Fordors Only	Price Kit	\$ 71.50
A56791B	1931 Slant Windshield Fordor - Rear doors and 1/4 Window	Price Kit	\$ 77.00

Tudor Sedan Rear Quarter Channel Kits

This kit includes the following: all necessary moulded channels with clips attached, upper window sponge seals, lower glass cushion bumpers and adhesive. One kit does both rear quarter windows.

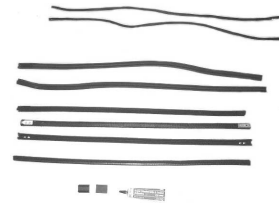

A56786 28-31 Tudor Sedan Rear Quarter Windows Price Kit \$ 44.00

Felt Glass Channel Clip

This clip goes at the bottom of each felt glass-channel to hold them in place. 2 Clips.

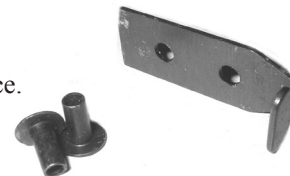

A45983CL Price Pair \$ 1.50

Top Window Cushion

Attach this 30" strip of sponge rubber to the top of the window track with any good auto trim adhesive. Forms a good cushion and seal.



A45985 28-31 Price Ea. \$ 2.25

Glass Bumper

This rubber bumper mounts on the ledge inside the door for the side window glass channel to rest on.

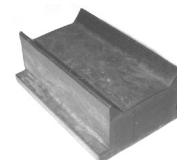

A48141 28-31 Price Ea. \$ 0.90

Mike's "A" FORD-ABLE Parts

Door Window Felt Metal Retainer

Spot Weld this metal "U" channel to the edge of the door to hold the glass felt in place. One tubular rivet is included to attach the bottom. 16 1/2" Long.



1930 - 1931 Tudors.

A55980	30-31	Hinge Side is the same on both doors	Price Ea.	\$ 10.25
A55981	30-31	Lock Side - Right Door	Price Ea.	\$ 10.25
A55982	30-31	Lock Side - Left Door	Price Ea.	\$ 10.25



1928 - 1929 Tudor Sedan.

A45980	28-29	Hinge Side - Right Door Lock Side - Left Door	Price Ea.	\$ 10.25
A45981	28-29	Hinge Side - Left Door Lock Side - Right Door	Price Ea.	\$ 10.25



1928 - Mid 1931 Briggs, Murray Town Sedan & Fordor

RAR235	28 - Mid '31	Front	Price Ea.	\$ 9.10
RAR236	28 - Mid '31	Rear	Price Ea.	\$ 8.20

Metal Glass Channel

This metal channel holds the bottom of the door glass and the window regulator fits into the slot on the bottom. Good for both sides, this fits all Tudors.



A45962	28-31	Tudors	Price Ea.	\$ 9.35
--------	-------	--------	-----------	---------

Metal Glass Channel

This metal channel holds the bottom of the door glass and the window regulator fits into the slot on the bottom. Good for both sides on Tudor rear windows.



A56787	28-31	Tudor Rear	Price Ea.	\$ 10.95
--------	-------	------------	-----------	----------

Metal Glass Channel

These are the hard-to-find glass channels for '31 Slant Windshield Fordors, Models 60-A,B,C. This is for the two arm regulators.



A45964BR	1931	Right side	Price Ea.	\$ 27.45
A45965BR	1931	Left side	Price Ea.	\$ 27.45

Metal Glass Channel

This metal channel holds the bottom of the door glass and the window regulator fits into the slot on the bottom. Used on Ford made Fordors and some Murray and Briggs Fordors.



A45963A	R. Front/L. Rear	Price Ea.	\$ 9.90
A45963B	L. Front/R. Rear	Price Ea.	\$ 9.90

Metal Glass Channel

USA Made channels to hold the bottom of the door glass on the Murray.



RAR242	Passenger Front Driver Rear	Price Ea.	\$ 37.50
RAR241	Driver Front Passenger Rear	Price Ea.	\$ 37.50

Glass Setting Rubber

This U-shaped rubber is used to mount the rear and quarter windows in the frame.



For Glass See Page Sedan 25.

A19003C	Quarter and rear windows	Price Set	\$ 10.25
A19003R	Rear window only	Price Ea.	\$ 4.95

Side Glass Setting Rubber

This has a lip for the Fordors - 6' Long.



A48138	28-31	Price Ea.	\$ 9.95
--------	-------	-----------	---------

Mike's "A" FORD-ABLE Parts

Insulation

Firewall Insulation

If you tour in the heat of the summer (and who doesn't?), you'll want one of these insulators to keep engine heat out. It mounts inside the firewall and is molded to look like the firewall.

A18572A
Shown

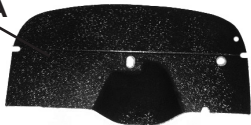

A18572A	28-29	Price Ea.	\$ 120.00
A18572B	1930 - 1931	Price Ea.	\$ 120.00
A18572C	1931 - Indented	Price Ea.	\$ 120.00

Complete Car Insulation

A multi - stage, automotive sound damping and insulation system for your Model A. Reduce engine and road noise, vibration and heat. This is the stuff that Henry Ford left out of original production and it makes all the difference in driving comfort! Should be able to install in approx. 2 hours. Complete instructions included. These are shipped directly from the manufacturer to you.

1928 - 1929 Tudor Sedan

A18805K	Complete Kit	Price Set	\$ 369.00
A18805A	Floor Kit	Price Set	\$ 119.00
A18805B	Body Panel Kit	Price Set	\$ 89.00
A18805D	Cowl Kit	Price Set	\$ 29.00
A18805E	Roof Kit	Price Set	\$ 119.00
A18801	Door Damper Kit	Price Set	\$ 29.00

1928 - 1929 Fordor Sedan

A18810K	Complete Kit	Price Set	\$ 399.00
A18810A	Floor Kit	Price Set	\$ 119.00
A18810B	Body Panel Kit	Price Set	\$ 89.00
A18810C	Cowl Kit	Price Set	\$ 29.00
A18810D	Roof Kit	Price Set	\$ 119.00
A18802	Door Damper Kit	Price Set	\$ 58.00

1929 Town Sedan

A18830K	Complete Kit	Price Set	\$ 399.00
A18830A	Floor Kit	Price Set	\$ 119.00
A18830B	Body Panel Kit	Price Set	\$ 89.00
A18830C	Cowl Kit	Price Set	\$ 29.00
A18830D	Roof Kit	Price Set	\$ 119.00
A18802	Door Damper Kit	Price Set	\$ 58.00

1930 - 1931 Tudor Sedan

A18840	Complete Kit	Price Set	\$ 369.00
A18840A	Floor Kit	Price Set	\$ 119.00
A18840B	Body Panel Kit	Price Set	\$ 89.00
A18840C	Cowl Kit	Price Set	\$ 29.00
A18840D	Roof Kit	Price Set	\$ 119.00
A18801	Door Damper Kit	Price Set	\$ 29.00

1930 - 1931 Fordor Sedan

A18845	Complete Kit	Price Set	\$ 399.00
A18845A	Floor Kit	Price Set	\$ 119.00
A18845B	Body Panel Kit	Price Set	\$ 89.00
A18845C	Cowl Kit	Price Set	\$ 29.00
A18845D	Roof Kit	Price Set	\$ 119.00
A18802	Door Damper Kit	Price Set	\$ 58.00

1930 - 1931 Town Sedan

A18850	Complete Kit	Price Set	\$ 399.00
A18850A	Floor Kit	Price Set	\$ 119.00
A18850B	Body Panel Kit	Price Set	\$ 89.00
A18850C	Cowl Kit	Price Set	\$ 29.00
A18850D	Roof Kit	Price Set	\$ 119.00
A18802	Door Damper Kit	Price Set	\$ 58.00

Floorboards

For more Floorboard related items see page Gen. 93 in our Running Chassis section.

Tudor Sedan Rear Floorboards

The **Tudor Sedan** had a wood floor board instead of metal pan. One goes under the driver's seat and the other in the back seat area.



AWD1256	28-31	Center	Price Ea.	\$ 33.00
AWD1258A	28-29	Rear	Price Ea.	\$ 33.00
AWD1258B	30-31	Rear	Price Ea.	\$ 33.00

Floorboard Seal

This black cotton webbing with tacks goes around the edge of the floorboard to seal out air and fumes. Tack to outside edge, then fold under the board and tack again for a tight seal.



A35130S	28-31		Price Set	\$ 4.50
---------	-------	--	-----------	---------

This kit seals the two additional wood floor pans on the **Tudor**. For **Tudor**- rear and center.

A35130S2	28-31		Price Set	\$ 6.95
----------	-------	--	-----------	---------

1930 Tudor owned by Mr. & Mrs. B. Bohanan

Floor Mats - Rear Mats

Mike also has the rear mats available for the Tudors.



A2055A	28-29	Tudor Sedan	Price Ea	\$ 59.95
A2055B	30-31	Tudor Sedan	Price Ea.	\$ 59.95

Floorboard Screws

Black oxide screws and washers to mount both the center and rear floorboards on the **Tudor Sedan**. 16 x 12/24 x 1 1/4" Flat Head Screws and Washers.



#34	28-31		Price Set/32	\$ 3.00
-----	-------	--	--------------	---------



GAS TANK

Specifications:

Steel thickness: .049" to .051" (terne plated)
Capacity: 28-29, 10 gal.; 30-31, 11 gal.

The following new parts are required to complete a restoration of your Gas Tank. This is only a guide - do not assume that this is all that is needed, all other parts need to be thoroughly checked.

1. Gas Tank Sealer - AGTS
2. Fuel Tank Welt Anti-Squeak - A9006
3. Gas Tank Filler Screen - A9020
4. Fuel Shut Off - A9189A or B
5. Fuel Shut Off Filter - A9193T or A9194B
6. Filter in Gas Bowl - A9156
7. Gas Lines - A9230A, B, A9230AV, BV, A9240B, C
8. Gas Gauge Tool - T9300
9. Gas Gauge Rebuilding Kit - A9320S
10. Gas Gauge Nut - A9326 - Inner - A9330 - Outer
11. Intake and Exhaust Manifold Gaskets - A9433F, A9433, A9433C, A9433C2
12. Carb Kit - A9595Z, B or T
13. Grose Jet - A9564GJZ, GJT or B9564Z
14. Choke Rod Assembly - A9700B or C
15. Grommet Set - A9066A or A9715/17
16. Control Rods - A9740S
17. Sediment Bowl - A9155
18. Sediment Bowl Gaskets - A9173 or N

Gas Tank Sealer

Extend the life of your old tank with this semi-elastic sealant. Seals pin holes, covers rust flakes, not affected by alcohol. Cannot be shipped by air. For best results, have the gas tank chemically cleaned and rust free before using this sealer.



AGTS 28-31 Price Quart \$ 25.00

Gas Tank Etching

Remove light rust inside of your gas tank before you put in the AGTS Gas Tank Sealer. This will leave a gray phosphate coating. 16 Oz.



A9002E 28-31 Price Each \$ 11.75

Cowl Welt

This roll of 1/8" black beading is used when you mount your gas tank.

'28-'29 Across back edge of tank and down sides of cowl.

'30-'31 Around back edge and sides.

Paint lower body color.

A3405CW 28-31 10 Ft. Roll Price Roll \$ 3.75



Gas Tank Anti-Squeak Welt

This 1/16" x 12 ft. woven fabric welt is used as a buffer around the gas tank to eliminate rattles. The early models use it all the way around the tank; the later models on the front and back edges.



A9006 28-31 Price Roll \$ 3.60

Gas Tank Filler Screen

This tab-style screen sits in the neck of the gas tank. Does not fit early threaded style. See page 441 of Service Bulletins for correct installation.

These will **not** work with tool - T9021 - below.

A9020 28-31 Price Ea. \$ 10.45



Gas Tank Filler Screen Tool

A great tool to help with the installation or removal of the Filler Screen (A9020). Place the tool in the filler neck notches and use a socket wrench and extension.

For original Screens Only.

T9021 28-31 Price Ea. \$ 3.75

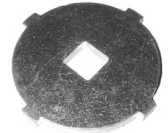

Gas Tank Protector

Lay this lined naugahyde on top of the tank when filling to protect your finish.

A9030P 28-31 Price Ea. \$ 21.95



Gas Tank Speedo Cable Grommet

This elongated grommet will help save your cable that runs under the gas tank in the tunnel to the speedo.

A9066R 28-29 Price Ea. \$ 3.45



Firewall to Gas Tank Screws

This set of screws has all the parts needed to attach the gas tank to the firewall.

Paint lower body color.

10 12-24 x 19/32 Pan Head Screw & Lockwasher.

#46 30-31 Price Set \$ 2.95



Mike's "A" FORD-ABLE Parts

Firewall to Gas Tank Bolts

This set of bolts is what you'll need to attach the gas tank to the firewall.

8 x 3/8 Tall Headed 1/4 - 20 5/8" Bolts, Lockwashers & 1/2" Nuts. 2 sets needed for the Fordor.

Paint lower body color.

#46A

28-29

Price Set/8 \$ 4.10



Gas Tank To Belt Rail Bolts

This set of bolts is what you'll need to attach the gas tank to the cowl. Bolts secure the back edge of the tank to the dash rail support.



#46B

28-29

1/4-20 x 1/2" Bolts, LW's & Hex Nuts

Price Set/24 \$ 3.85



#46C

Early 1930

12 x 1/4" - 20 3/4" Bolts & l.w.

Price Set/36 \$ 3.85



#46D

Mid 1930

Size changed to 5/16-24 x 25/32" Bolts, LW's and Nuts.

Price Set/36 \$ 3.85



#46E

Late 1930 to End -

The same 5/16-24 x 25/32" Bolts were used, except the nuts were placed inside a cage. Unfortunately these cage nuts are no longer available.

Price Set/24 \$ 4.85

Gas Cap

Vented gas cap in the style used for '28-'29 cars. Chrome over brass. Includes gasket.



A9030A

28-29

Price Ea. \$ 17.90

Show Quality Gas Cap

Vented stainless steel gas cap for '30-'31. This is the best quality available. It's a copy of the original Eaton style cap. These really fit. Includes the correct gasket.



A9030C

30-31

Price Ea. \$ 19.95

Gas Cap Gaskets

Treated leather gaskets.



A9035A

28-29

Price Ea. \$ 0.65

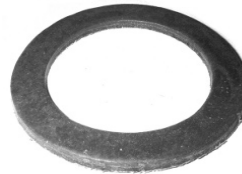

A9035

30-31

Price Ea. \$ 0.95

Sediment Bowl Repair Kit

Rebuild kit to improve the functioning of original cast iron sediment bulb on the firewall.

Instructions included.



A9155RK

28-31

Price Kit/3 \$ 4.75

Glass Sediment Bowl Micro Filter

Improve the efficiency with this filter which fits inside the glass bowl.

Instructions included.

Can only be used with A9155 - See

Page Sedan 50.

A9156

28-31

Price Set/3 \$ 4.50



Sediment Bowl Screen

This brass screen fits between the bowl gasket and the bulb housing on the glass sediment bulbs

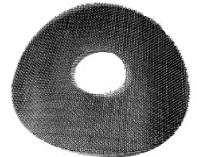

A9155SC

28-31

Price Ea. \$ 1.65

Mike's "A" FORD-ABLE Parts

Sediment Bowl Assembly

Glass sediment bowl was originally an option from **Mid '29** but will work on all A's, except for indented firewalls. Gasket (A9173 - below) and Screen (A9155SC - Page Sedan 49) are included. Use Micro Filter (A9156 - Page Sedan 49) in this Bowl.



A9155 28-31 Price Ea. \$ 26.95

Late '31 Filter Kit

Use this kit if you are NOT running the correct side-bowl style Zenith Carb. Designed to accommodate the late 1931 Model A's with the gas valve on the firewall. Includes a glass bowl type sediment bulb along with gas lines and fittings to install. The copper sediment bowl screen can be replaced by using A9155SC.

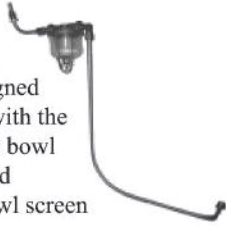

A9155L 1931 Price Kit \$ 27.95

Sediment Bowl Gaskets

For the glass sediment bowl. Neoprene should be replaced when you remove the bowl.



A9173 28-31 Cork Price Ea. \$ 0.35



A9173N 28-31 Neoprene Price Ea. \$ 0.55

Sediment Bowl Glass

Replace your discolored bowl with a new clear one.



A9158 28-31 Price Ea. \$ 5.50

Side Bowl Filter

On the **late '31** A's, Ford moved the filter to the side of the carburetor. Complete with all hardware.



A9161 1931 Price Set \$ 51.00

Side Bowl Filter Without Hardware

If all you need is the side bowl filter, and not all of the hardware.



A9161A 1931 Price Ea. \$ 33.00

1928 to 1931 Cast Iron Sediment Bowl

7/8 - 14 Nut
(1-1/4 Wrench)
A9156A

Lock Washer

These three items are not available new.

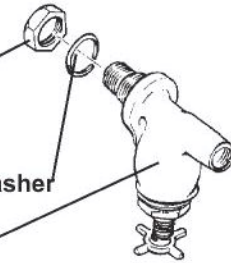

Mid 1929 to Early 1931 Glass Sediment Bowl



Cork / Neoprene Gasket - A9173 & N

Screen -
A9155SC

Glass Bowl -
A9158

Special Nut
(No Lock Washer)
- Not Available

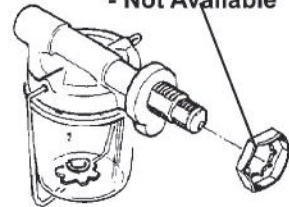

Thanks to Les Andrews for the use of his drawings.

Side-Bowl Rebuild Kit

With this you can rebuild your side bowl filter. Mounted on the side of the carb.



A9161SC Late 1931 Price Kit/3 \$ 2.25

Side Filter Bolt

This is the special bolt to hold the side bowl filter to the carb on the **late '31** A's.



A9161B 1931 Price Ea. \$ 4.60

Side Bowl Drain Valve and Spring

For the **late '31** A's, this drain needle with spring screws into the bottom of the filter.



A9161V 1931 Price Ea. \$ 6.35

Sediment Bowl Brass Cap Plug

For Cast Iron bulbs. Goes into the bottom of the cast iron sediment bulb and A9177 threads into it.



A9175 28-31 Price Ea. \$ 8.50

Mike's "A" FORD-ABLE Parts

Sediment Bowl Brass Drain Valve & Forged Drain & Spring.

For Cast Iron bowls.



A9177 28-31 Price Set \$ 11.95

Installation of Repair Kit for Cast Iron Bowl

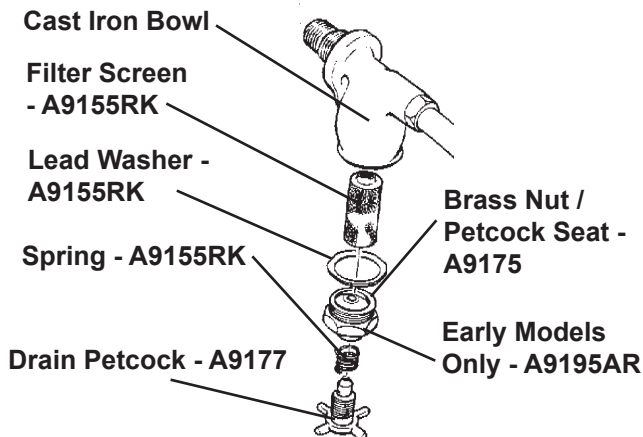

Fuel Shut off Valve

This all brass valve is inside the car to shut the gas off going to the carb.



A9189A 28-31 Price Ea. \$ 32.25



Installation of Fuel Shut Off & Gas Tank Screen (A9193T) into A9189A

Gas Tank Screen (Fuel Shut Off)

This screen presses into the gas shut-off valve where it goes into the gas tank to keep sediment and rust out of the carb.



A9193T 28-31 Price Ea. \$ 3.15

Fuel shut Off Valve Packing Nut

This brass nut holds the packing in place the sediment bulb.



A9195AR

A9195AR	1928 - late 1929	Price Ea.	\$ 3.50
A9195B	1929-1931	Price Ea.	\$ 2.50

Late '31 Gas Shut Off Valve

This all brass valve was used on the late '31 A's with the indented firewall. This is fitted onto the firewall in the engine compartment.



A9189B 1931 Price Ea. \$ 36.95

Electric Fuel Cut Off Don't Leave this off!!!!

How often have we forgotten to switch off the gas. Well now you don't have to, just leave your gas on and let the Electric Fuel Cut Off do the job for you. Made to go on your 1/4" fuel line that runs from the firewall to the carburetor. Simply Turn the key On or off - THAT'S IT. Comes with Complete instructions. Available in 6 or 12 Volt.



A9189	28-31	6 Volt	Price Set	\$ 55.00
A9189/12V	28-31	12 Volt	Price Set	\$ 55.00

Fuel Valve Grommet

For the late '31 valves that mount on the firewall, you'll need this excellent repro. to go in the hole.



A9171 1931 Price Ea. \$ 1.95

Gas Shut Off Fuel Valve Handle Only

Handle only for the earlier (A9189A) shut off valve.



A9189H 28-31 Price Ea. \$ 2.95

Gas Shut Off Fuel Valve Handle Only

This is the forged style handle used from the beginning until April 1929.



A9191A 28 - April 29 Price Ea. \$ 13.95

Gas Shut off Valve Packing

If your shut off valve isn't shutting off, try replacing the packing before buying a new valve.



A9193 28-31 Price Ea. \$ 0.95

Mike's "A" FORD-ABLE Parts

Gas Valve Repair Kit

Use this complete kit to rebuild the original style gas valve. Includes packing, jam nut, lock washer and gas resistant lubricant. Will also fit late '31's.



A9193S 28-31 Price Set/4 \$ 2.50

Inside Gas Lines

This line connects the gas valve under the gas tank to the sediment bowl on the firewall. 5/16" tubing.



A9230A 28-29 Price Ea. \$ 7.50



A9230B 30-31 Price Ea. \$ 6.75

Modern Gas Line Valve

If you are having continuous trouble with your gas line valve - we now have a modern valve in line - this guarantees a complete shut off with a quarter turn of the handle. Leave your A9189A or B in place then attach the A9230AV or BV.

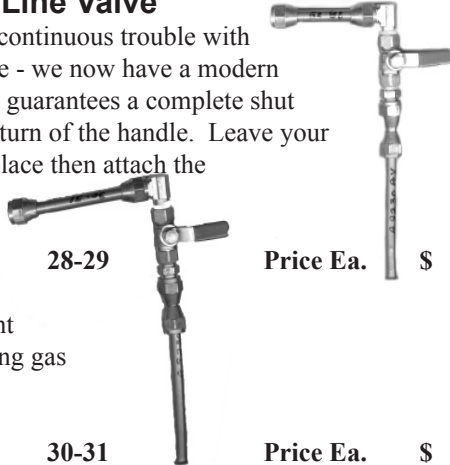

A9230AV 28-29 Price Ea. \$ 55.00

This is an excellent solution to a leaking gas problem.

A9230BV 30-31 Price Ea. \$ 55.00

Gas Line

This line with brass fittings connect the sediment bulb to the carb. Not for the late '31's A's.

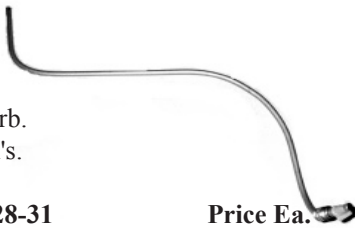

A9240B 28-31 Price Ea. \$ 4.50

For the late '31's with indented firewalls and side bowl carburetors. Includes Fittings.



A9240C 1931 Price Ea. \$ 4.60

Gas Line Fitting

Like the original brass gas line fittings.



A9243 28-31 Price Ea. \$ 1.50

Gas Line Fittings

Like the original 9/16 head fittings used on the late '31 A's. Set ferrule no more than 1/8" from the end of the tube.

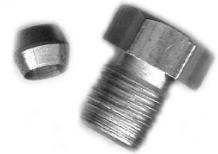

A9243B 1931 Price Set \$ 2.80

Gas Tank Clamps

Hold the bottom of the gas tank stable with these. 5 per side needed for '28-'29; 2 per side needed for '30-'31.



A35266AR 28-29 10 Needed Price Ea. \$ 2.30



A35266BR 30-31 4 Needed Price Ea. \$ 2.40

Order Online Now and Save 5%

Visit our website for all your Model "A" needs.



www.mikes-afordable.com

SEDAN

GAS GAUGE

Tool Set

Safely work on your gas gauge with this cast aluminum heat treated tool set. Will not damage nuts.



T9300 28-31 Price Set/2 \$ 6.45

Gas Gauge Assembly

Complete assembly
Inner and Outer Nut &
Gaskets.

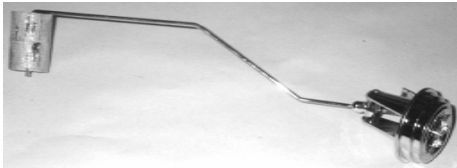

A9312D 28-31 Price Set \$ 36.30

Gas Gauge Assembly

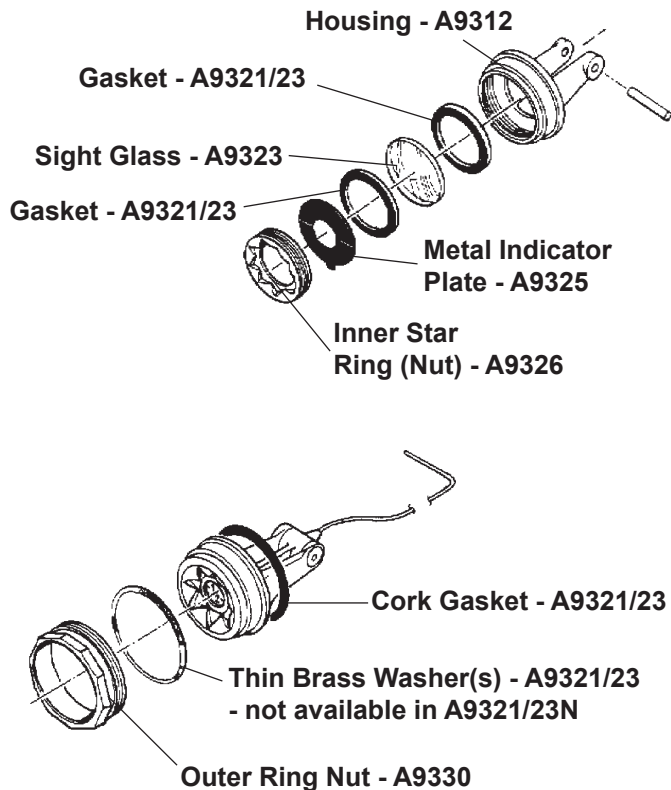

Thanks to Les Andrews for the use of his drawings.

Gas Gauge Rebuilding Set

This set includes cork gaskets, lens, face plate and cork float. The order is gasket, glass, gasket, face plate, inner nut.

Large gasket against tank, gas gauge assembly, brass washer & outer nut.



A9320S 28-31 Price Set/9 \$ 5.95

Gas Gauge Cork Float Only

You can buy this cork float separately if its all you need.

Treated to resist gas.



A9312F 28-31 Price Ea. \$ 1.95

Gas Gauge Neoprene Float

You can now get a Gas and Alcohol proof float to eliminate the problem of having your cork float disintegrate over time in the gas.



A9313B 28-31 Price Ea. \$ 4.45

Gas Gauge Brass Float

Modern style gas float based on the design of a carburetor float. You should never have any trouble with this.

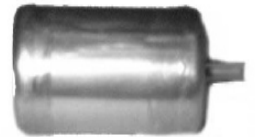

A9313C 28-31 Price Ea. \$ 9.95

Gas Gauge Gaskets

Choose between cork like Ford used or modern neoprene.

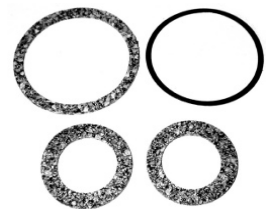

A9321-23 28-31 Cork Price Set/4 \$ 1.25

A9321-23N 28-31 Neoprene Price Set/4 \$ 1.75

Gas Gauge Lens

Glass lens.

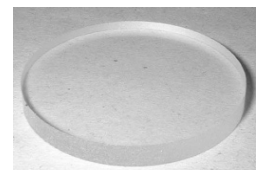

A9323 28-31 Price Ea. \$ 0.95

Gas Gauge Face Plate

Like the original.

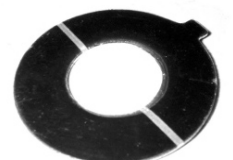

A9325 28-31 Price Ea. \$ 2.10

Mike's "A" FORD-ABLE Parts

Gas Gauge Inner Nut

Chrome Finished inner nut for the "A" gas gauge.



A9326 28-31

Price Ea. \$ 6.55

Gas Gauge Outer Nut

Chrome finished outer nut for the "A" gas gauge.



A9330 28-31

Price Ea. \$ 6.75

"B" Fuel Pump Rebuild Kit

A complete rebuild kit for your '32-'34 4 cy. fuel pump.



B9349A 32-34

Price Set \$ 39.95

"B" Fuel Pump Gasket

This gasket goes between the block and the fuel pump on a "B" 4 cyl. engine.

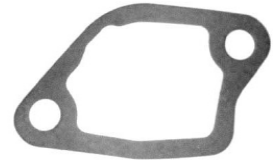

B9374 32-34

Price Ea. \$ 1.00

"B" Fuel Pump Diaphragm

Included in the B9349A kit.

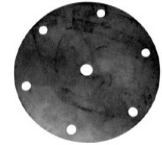

B9390 32-34

Price Ea. \$ 5.00

1931 Slant Windshield Fordor previously owned by Mr. & Mrs. E. Lindeman of Mike's "A" Ford-able Parts. (Mike's daughter and Son-in-law.)



SPEEDOMETER

Speedometer Mount Set

This set of 2 screws, nuts, and lock washers is used to mount your speedometer to the instrument panel.



A17255MB 28-31 2 x 1/4" - 20 x 1/2" screws + 1/2" square nut & lock washer
Price Set/4 \$ 0.80

Rebuilt Speedometers

Sold on **EXCHANGE ONLY**. Mike must have your complete re-buildable core to ship a rebuilt one out.
NO OUTRIGHT SALES.
NO EXCEPTIONS.



Only Stewart Warner Speedometers are still being rebuilt.

A17255AS 28-30 Oval face Price Ea. \$ 225.95
A17255BS 30-31 Round face Price Ea. \$ 225.95

Speedometer Bezel Rim - Nickel

Shiny new face plate to replace that cracked or broken plate.



A17259A 28-30 Oval S/W Price Ea. \$ 19.95
A17259C June '30-31 Round S/W Price Ea. \$ 16.75
A17259D June '30-31 Round Waltham Price Ea. \$ 16.95

Speedometer Lens

If your old glass lens has gotten scratched or dingy over the years, replace it with one of these.

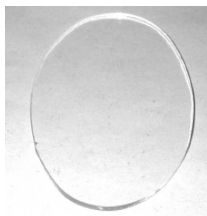

A17256AR Oval Price Ea. \$ 1.10
A17256B Round Price Ea. \$ 1.00

Speedometer Lens Gaskets

Mike also has new gaskets for the speedometer lens.



A17257AR 1928 - June '30 Oval face
Price Pair \$ 1.15
A17257B July '30 - 1931 Round face
Price Pair \$ 1.15

Speedometer Lens Retainer

This ring holds the lens into the chrome face for the round speedometer. Sorry not available for Oval Lenses.



A17258B 30-31 Price Ea. \$ 3.25

Speedometer Face Plate

This is the black plate that fits behind the chrome facing on the Speedometer.

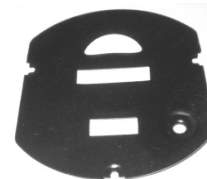

A17268A 28 - June 30 Oval speedo
Price Ea. \$ 6.20
A17268C June 30 - 1931 Rnd Stewart Warner
Price Ea. \$ 6.80
A17268D June 30 - 1931 Round Waltham
Price Ea. \$ 7.85

Speedometer Decals

Replace your tired number decal with the right new one.



A17255A '28- June '30 Oval Faces Speedo
Price Ea. \$ 2.75
A17255B July '30-31 Round Faced Stewart Warner - 7/8" Wheel
Price Ea. \$ 2.75
A17255C July '30-31 Round Faced Waltham - 3/4" Wheel
Price Ea. \$ 2.75
A17255D July '30-31 Round Faced Northeast
Price Ea. \$ 3.00

Mike's "A" FORD-ABLE Parts

Speedometer Calibration by Wiley Higgins

While driving a Model A, the optimum driving speed is a steady 45 MPH. This speed moves you along at a good pace and helps keep you out of the way of most traffic, while not putting too much strain on your engine. If your Model A won't hold a steady 45 M.p.h., something needs to be corrected.

First of all, a Model A Speedometer usually is *not accurate* after over 60 years of use, even it has been rebuilt by a professional. Also, tire size and rear-end ratio have an effect. So, your speedometer may indicate a different speed than you are actually travelling down the road - either faster or slower.

The best method of determining the **actual speed** you are travelling is to **conduct a time/distance check**. Here's how:

1. Select a reasonably **straight and level stretch** of highway.
2. Use your digital or sweep second hand watch as a stop watch.
3. As you pass any **mile post** (remember, straight and level is best), start the stop watch or note the seconds on the sweep second hand.
4. **Hold the same, steady speed for one mile** to the *next* mile post, and **note how many seconds have elapsed.**
5. **Consult the chart below to determine your true speed over the ground.**
6. **Repeat steps 1. through 5.** above two or three times and **get an average.**
7. Adjust your speed over the ground slower or faster if you have a speedometer error to hold a steady 45 M.p.h.. For example, it takes **80 seconds** to go **1 mile** if your *true* ground speed is **45 M.p.h..**

SEC (1 Mile)	MPH	SEC (1 Mile)	MPH
102	35.3	86	41.9
101	35.6	85	42.4
100	36.0	84	42.9
99	36.4	83	43.4
98	36.7	82	43.9
97	37.1	81	44.4
96	37.5	80	45.0
95	37.9	79	45.6
94	38.3	78	46.2
93	38.7	77	46.8
92	39.1	76	47.4
91	39.6	75	48.0
90	40.0	74	48.7
89	40.5	73	49.3
88	40.9	72	50.0
87	41.4		

IT MEASURES YOUR MILES

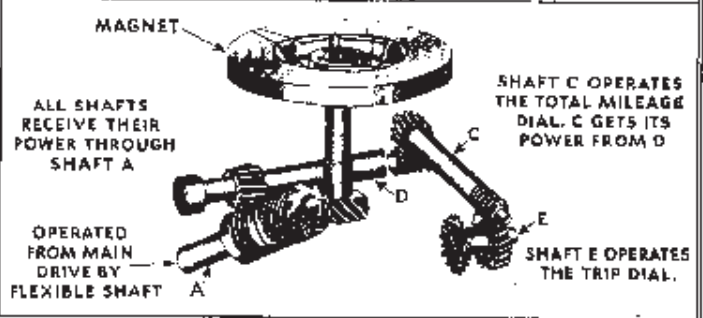
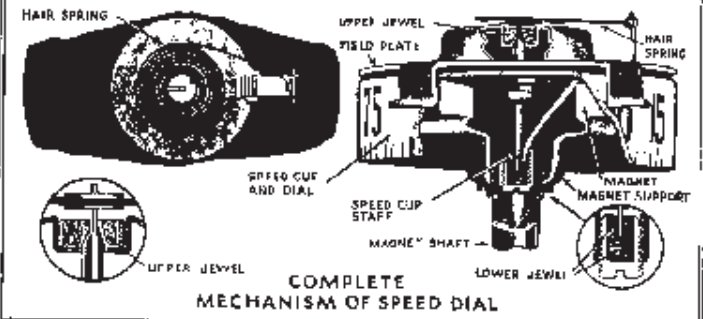
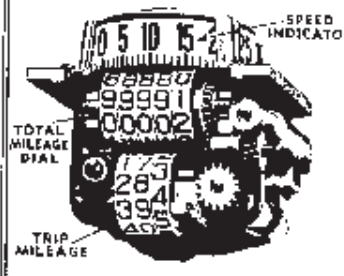

Speedometer Trip Stem

Nickel plated, knurled stem that pulls out on the Oval Speedo to set the odometer. Complete stem assembly with gear and retaining washer.



A17267 28 - Mid 1930 Price Set \$ 20.00

Speedometer Grommet

This speedometer grommet fits in the firewall for the cable to go through, next to the choke rod.



A14567 28-31 Price Ea. \$ 0.75

Gas Tank Speedometer Cable Grommet

This elongated grommet will help save your cable that runs under the gas tank in the tunnel to the speedo.



A9066R 28-29 Price Ea. \$ 3.45

SEDAN

Mike's "A" FORD-ABLE Parts

Water Inlet - Speedo Cable & Cut-out Wire Clip

This wire clip was used in several places by Ford: for the water inlet and speedometer cable inside the firewall for all years; for the cutout wire on the firewall in 30-31.



A14577A 28-31

Price Ea. \$ 1.50

Firewall Wire Clip Bolt (Round)

This is the correct round head screw with lock washer to attach the wire clip to the firewall.

Paint Black. Use with A14577A above & B - Page Gen. 196.

A14577BR 28-31 12/24" x 1/2" screw & l.w.



Price Set/2 \$ 0.40

Speedometer Cables

Due to the fact that there are several manufacturers of interior cables and they are all being reproduced in different lengths, thereby causing a lot of confusion and problems we are no longer stock inner cables seperatly.

Replace your worn out speedometer cable with one of these new complete assemblies with steel ends. Mike's note: The early Ford cable was 1/2" in diameter while the latter was 1/4". The early gear on the drive shaft key has a round cable end with key up. The '30-'31 accepts the square cable.



Speedo End Square - Drive end Keyed

A17260AU 1928 - June '30

USA (oval)
Price Ea. \$ 33.95

Speedo End Square - Drive end Square

A17260B July '30 - 31

USA (round)
Price Ea. \$ 26.95

Black Vinyl Covered Speedometer Cable

An inexpensive alternative to the original flexible cables. For the round speedometer.



A17260C 30 - 31

Price Ea. \$ 15.00

Speedometer Lube

If your cable is OK but not turning smoothly, get this 7cc packet of graphite lubricant.



A17260L 28-?

Price Ea. \$ 2.95

Speedometer Support Clip

This support clip with mounting hardware goes on the frame rail to hold the speedometer cable.



5/16-24 x 11/16 Bolt, Lockwasher and Nut

A17265A 28-30 Oval speedo -

Price Ea. \$ 2.75

A17265B 30-31 Round speedo

Price Ea. \$ 2.75

Speedometer Drive Gears Only

Mike also has the drive gears available for both the 3.54 and 3.78 rear end gears.



A17270A 28-29 19 Tooth Gear used with 21" and 19" Tires

Price Ea. \$ 14.60



A17270B 30-31 18 Tooth Gear used 19" Tires

Price Ea. \$ 12.25

Extra High Speed Drive Gear

This gear goes in the speedo drive assembly that bolts to the bottom of the torque tube.

This is a high strength plastic 17 tooth gear that is used with the A4209XHS.

See Page Gen. 84.



A17270C 28-31 3:27 Ratio - 17 Tooth

Price Ea. \$ 29.95

Speedometer Housing Only

New Housings are now available.

Replace your worn housing with a new one.



A17271 28-31

Price Ea. \$ 41.00

Mike's "A" FORD-ABLE Parts

Speedometer Housing and Gear Assembly.

A complete new housing and gear assembly have been made from the FORD blue print. Includes gear, shaft and retainer. Order Gasket A17275 Separately.



- | | | |
|---------|--|--------------------|
| A17271A | 1928 - June 1930 - Standard Gear with Round Hole Shaft for 21" Tire | Price Ea. \$ 56.95 |
| A17271B | June 1930 - 1931 - Standard Gear with Square Hole Shaft for 19" Tire | Price Ea. \$ 56.95 |
| A17271C | 1928 - June 1930 - High Gear with Round Hole Shaft for 21" Tire | Price Ea. \$ 56.95 |
| A17271D | June 1930 - 1931 - High Gear with Square Hole Shaft for 19" Tire | Price Ea. \$ 56.95 |



A17270A, B or C



A17275

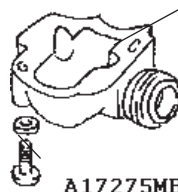

A17271A, B, C or D

A17275MB

A17273S or R

A17274A or B

Speedometer Gasket

Here's a gasket to get the proper gear mesh on the gear case.



- | | | |
|--------|-------|-------------------|
| A17275 | 28-31 | Price Ea. \$ 0.50 |
|--------|-------|-------------------|

Speedometer Gear and Case Mount Bolts

Mike has this set of two fine-threaded bolts with lockwashers to bolt the speedometer gear and case to the torque tube.



- | | | | |
|----------|-------|---------------------------------|---------------------|
| A17275MB | 28-31 | 2 x 1/4" - 28 x 1" bolts & l.w. | Price Set/4 \$ 0.60 |
|----------|-------|---------------------------------|---------------------|

Speedometer Drive Gear Shaft

The end of the speedometer cable slides into this shaft in the gear/case assembly that bolts to the torque tube. Square end (S) and Round end (R) available.



- | | | | |
|---------|-----------------|---------------------------------|--------------------|
| A17273R | 1928 - June '30 | Round ended cable / Oval Speedo | Price Ea. \$ 12.95 |
|---------|-----------------|---------------------------------|--------------------|



- | | | | |
|---------|----------------|-----------------------------------|--------------------|
| A17273S | July '30 - '31 | Square ended cable / Round Speedo | Price Ea. \$ 12.95 |
|---------|----------------|-----------------------------------|--------------------|

Speedometer Shaft Retainer

This retainer goes into the threaded end of the gear and case to prevent the shaft from coming out.



- | | | |
|---------|--------------------------------|-------------------|
| A17274A | 28 - July '30 - Short Retainer | Price Ea. \$ 1.40 |
|---------|--------------------------------|-------------------|



- | | | |
|---------|-----------------------------------|-------------------|
| A17274B | July '30 - 1931 - Longer Retainer | Price Ea. \$ 1.40 |
|---------|-----------------------------------|-------------------|

Speedometer Snap Ring

This snap ring holds the speedometer drive gear and thrust washer in place on the drive shaft.



- | | | |
|--------|-------|-------------------|
| A17286 | 28-37 | Price Ea. \$ 0.75 |
|--------|-------|-------------------|

Speedometer Thrust Washer

The thrust washer goes onto the drive shaft between the bearing and the speedometer drive gear.



- | | | |
|--------|-------|-------------------|
| A17290 | 28-48 | Price Ea. \$ 1.95 |
|--------|-------|-------------------|

MIRROR

Rear View Mirror Screws

This is the set of round headed machine screws to hold the mirror on the '28-'29

Closed Car. 3 x 10-32 x 5/8 Round Head Screws with washers and nuts.
A17681AMB 28-29



Price Set/3 \$ 1.50

Rear View Mirror Mount Screws

This set of 3 chromed oval headed wood screws is used to mount the rear view mirror to the wooden header.

3 x #10 x 1" Oval Head Screw.

A17681BMB 30-31



Price Set/3 \$ 1.00

Inside Rear View Mirror Bracket Clip

These fit the mirrors A, B, C H and G as seen in Judging Standards.

RAR252



Price \$ 4.95

Closed Car Mirror

This mirror has a black painted frame for the '28-'29 Closed Car.

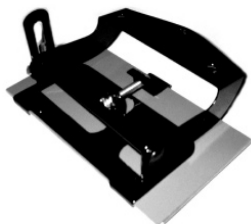

A17682AS 28-29 Black Price Ea. \$ 19.25

Closed Car Mirror

Mike has both the black and the Stainless rear view mirrors for the '30-'31 Closed Car.



A17682BS 30-31 Black Price Ea. \$ 23.65
A17682SS 30-31 Stainless Price Ea. \$ 30.25

Rear View Mirror Glass

If your mirror is cloudy or the plating has worn off, replace it with one of these quality beveled mirrors. The smaller is correct but the larger gives better visibility.



A17704 Original Size - 2-1/2" x 4 1/2" Price Ea. \$ 5.50
A17704B 2-1/2" x 6" Price Ea. \$ 6.50

Closed Car Clamp On Mirror (Peep Mirror)

This mirror fits any closed car by clamping onto the front of the door edge with two set screws. Chrome bracket with polished stainless mirror head. **4" Mirror.**



A17741U 28-31 Price Ea. \$ 25.95

Closed Car Peep Mirror

A chrome mirror that will easily attach in just minutes. Attach the two set screws to the top of the door. Can be used on either the driver or the passenger side door.



A17700PL 28-31 Price Ea. \$ 21.95

Closed Car Hinge Mirror

This mirror with mounting pin fits all '28-'31 Closed Cars. Chrome bracket with polished stainless mirror head that adjusts.



28-29 Shown

4" Mirror. Not for Slant Windshield Cars.

A17741A 28-29 Left or Right Price Ea. \$ 39.05
A17741BL 30-31 Left Price Ea. \$ 39.05
A17741BR 30-31 Right Price Ea. \$ 39.05

Hinge Mirror Head Only

If the hinge arms are still in good shape and all you need to replace is the mirror - these are now available.



B17741MH 28-30 Price Ea. \$ 20.20

Mike's "A" FORD-ABLE Parts

Hinge Mirror Pin

This chrome finished pin will come with any new Hinge Mirror. A longer pin is required when installing mirrors on your car.



Not for Slant Windshield Fordors.

A17741HPI 28-31 Price Ea. \$ 2.45

Sidemount Mirror

This style sidemount mirror is attached with a leather strap.



B17700SM Price Ea. \$ 47.30

Clock Mirrors

Mirror clocks are designed especially for the Model A Fords. Two of the outstanding features found in each Clock Mirror are the beautiful beveled quality mirror along with the accurate and dependable Quartz timepiece with its Arabic or Roman Numeral dial reflecting styles of the past. Comes with a 2 year manufacturer warranty. Please make sure that your bracket will adjust to hold a 2" high mirror. Shown on a bracket - this is NOT included.



A17705AS	Silver Arabic	
A17705AG	Gold Arabic	
A17705RS	Silver Roman Numeral	
A17705RG	Gold Roman Numeral	
		Price Ea. \$ 95.00

Clock Mirror with Polished Edge

A beautiful replacement clock mirror with a polished edge. The mirror is not glass.



A17706 28-31 Price Ea. \$ 39.95



On tour with the club in Savannah, GA. Mr. & Mrs. B. Delongs 1931 Deluxe Tudor

1929 Briggs 60A

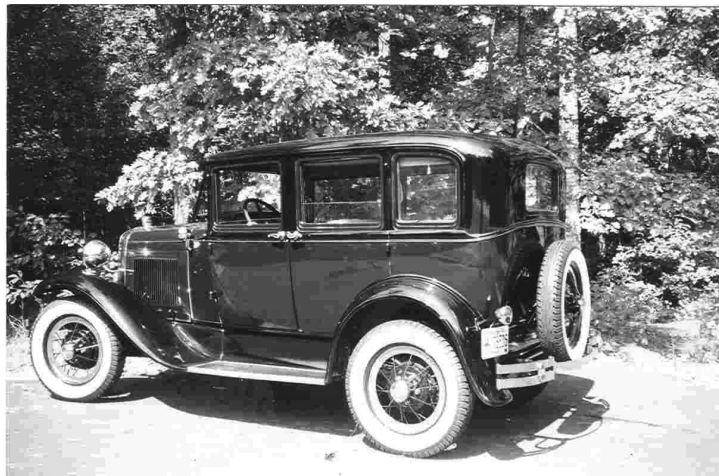

COWL LIGHT

The following new parts are required to complete a restoration of your Cowl lights. This is only a guide - do not assume that this is all that is needed, all other parts need to be thoroughly checked.

1. Bulbs - A13466
2. Arms - A13301AR or BS
3. Screw Set - A13302BT
4. Mounting Plate - A13303
5. Mounting Plate Rivet - A13307
6. Rim Tab - A13305
7. Lens - A13308AR, D or DA
8. Gaskets - A13309A or C
9. Mounting Bolts - A13327
10. Pigtails - A13412
11. Sockets - A13338
12. Reflectors - A13315C
13. Rim Retainer Clips - A13316S
14. Cross Over Wire - A13302XO

Cowl Lights Arm Position Template

Drivers Side - 1930 - 31 Cowl Lights

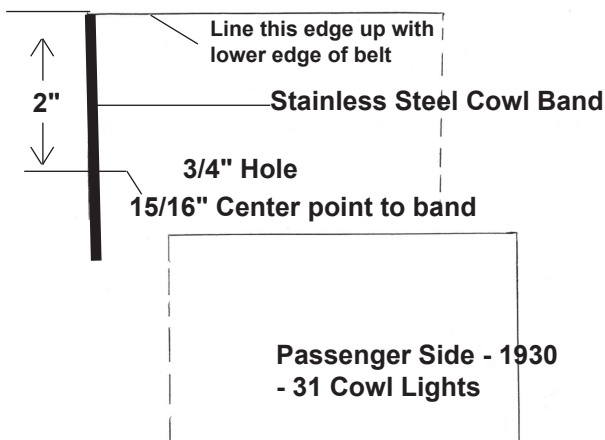

Cowl Lights

Beautiful reproductions! The '28-'29's are chrome and the '30-'31's are stainless with chrome arms.



A13302AR	28-29		Price Pair	\$ 170.00
A13302ES	30-31		Price Pair	\$ 126.00
A13302ARTS	28-29	6V w/turn signal	Price Pair	\$ 187.00
A13302ESTS	30-31	6V w/turn signal	Price Pair	\$ 149.00

Tail Light, Parking Light, Cowl, Instrument Panel & Dome Light Bulb

3 Candle Power as original.
10 Candle Power is available if you would prefer a brighter bulb.

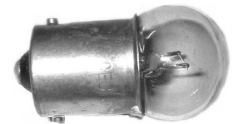

A13466/3	3 CP	Price Ea.	\$ 0.90
A13466/10	10 CP	Price Ea.	\$ 1.25

Tail Light & Parking Quartz Bulbs

If you want a lot more light, use these direct replacements for your original bulbs. These are also known as "Ugly Bulbs".

Will not work with sealed beam or halogen headlights.



Tail Light and Parking: 50/20 Watt

B13466Q6	6 Volt	Price Ea.	\$ 13.75
B13466Q12	12 Volt	Price Ea.	\$ 11.00

Cowl Light Turn Signal Conversion Kit

This kit can convert both cowl lights to turn signals. It uses a double-filament bulb so it can be used as a parking light as well.



A13303TSAR	28-29	6V	Price Set	\$ 46.24
A13303TS	30-31	6V	Price Set	\$ 46.24
A13303TSAB	28-29	12V	Price Set	\$ 46.24
A13303TSB	30-31	12V	Price Set	\$ 46.24

Mike's "A" FORD-ABLE Parts

Cowl Light Turn Signal Bulb Only

The turn signal kit uses this double filament bulb. Offset tabs.



A13304/6	6 Volt	Price Ea.	\$ 2.10
A13304/12	12 Volt	Price Ea.	\$ 2.10

1928-1929 Cowl Light Arms

These chrome plated cowl light arms may be all you need if your light buckets are still in good shape.



A13301AR	28-29	Price Pair	\$ 82.50
----------	-------	------------	----------

1930-1931 Cowl Light Arms

Good chrome-plated arms for the '30-'31 cowl lights.



A13301BS	30-31	Price Pair	\$ 87.95
----------	-------	------------	----------

Cowl Light Arm Mounting Plate

This plate fits inside the bucket that the arm mounting screws go into.

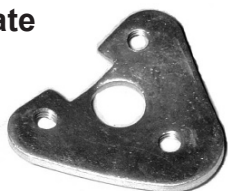

A13303	30-31	Price Ea.	\$ 3.05
--------	-------	-----------	---------

Cowl Light Arm Mounting Plate Rivet

This tubular rivet holds both the Mounting Plate (A13303) and the Rim Tab (A13305) to the bucket.



A13307	30-32	Price Ea.	\$ 0.60
--------	-------	-----------	---------

Cowl Light Mount Bracket

You'll need these brackets for inside the cowl section if you're installing cowl on your "A".

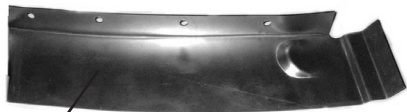

A13300BR	28-29	Price Pair	\$ 48.00
A13300BB	30-31	Price Pair	\$ 46.00

Cowl Light Marking Tool

This little tool takes the guesswork out of deciding where to drill new holes when installing a cowl light.

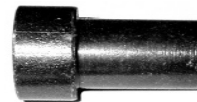

T13300X	28-31	Price Set	\$ 4.25
---------	-------	-----------	---------

Cowl & Tail Light Visor

Match up your cowl lights with a visor set. Just like the headlight set. See page 210 for Headlight visors.



A13001A	28-31	W/Jewel	Price Pair	\$ 23.00
---------	-------	---------	------------	----------

Cowl Light Rims

Highly Polished Stainless Steel rim.



A13306AR	28-29	Price Ea.	\$ 14.00
A13306B	30-31	Price Ea.	\$ 14.00

Cowl Light Rim Retainer Clips

This set of retainer clips will hold the lens to the rim for both your '30-'31 cowl lights.



A13316S	30-31	Price Set / 4	\$ 1.15
---------	-------	---------------	---------

Cowl Light Rim Tab

The rim screw goes into this small tab.



A13305	30-31	Price Ea.	\$ 2.55
--------	-------	-----------	---------

Cowl Light Lens

Clear lens.

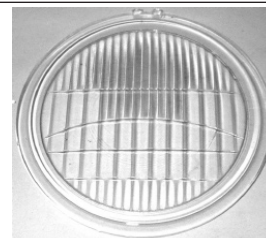

A13308AR	28-29	Price Ea.	\$ 6.55
A13308D	30-31	Price Ea.	\$ 4.35

Mike's "A" FORD-ABLE Parts

Amber Cowl Light Lens

If you've converted to a turn signal, these amber lenses will show up better.



A13308DA 30-31 Price Ea. \$ 6.75

Lens Gaskets

Replace yours to keep moisture out, extend the life of the bulb.

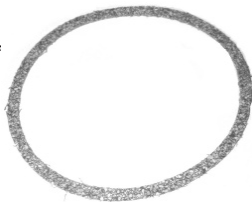

A13309A 28-29 Price Pair \$ 1.15
A13309C 30-31 Price Pair \$ 1.15

Cowl Light Reflector

This nice chrome reflector with bulb socket fits the '28-'29 cowl lights.



A13315AR 28-29 Price Ea. \$ 14.25

Cowl Light Reflector

Brand new, well polished reflectors for your '30-'31 cowl lamps.



A13315C 30-31 Price Ea. \$ 8.75

Cowl Light Screw Set

Stainless screws with lock washers to attach the cowl light to the cowl light bucket. 14 Piece Set. 6 x 10/32 x 1/2" & Washers



A13302BT 30-31 Price Set/14 \$ 2.00

Cowl Light Socket

Replacement socket for the '30-'31 cowl light bulb. Has the rivet, but no wire pigtail.



A13338 30-31 Price Set \$ 3.75

A13339 Rivet only Price Ea. \$ 0.50

Cowl Light Cross Over Wire

This wire connects the two cowls and runs a single wire to the wiring harness.



A13302XO 28-34 Price Ea. \$ 8.25

Cowl Light Wire Connector

This special ceramic connector was located at the base of the steering column to connect the cross over wire to the harness.



A13302C 28-31 Price Set \$ 7.95

Cowl Light Wood Blocks

These were used in '30-'31 to prevent denting. They fit between the cowl panel and the brace that the arm bolt goes through.

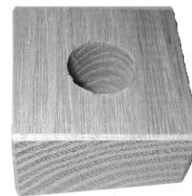

A13318 30-31 Price Pair \$ 3.95

Cowl Light Mount Bolt

This bolt has a hole through it for the cowl wire to go through. It mounts the light to the body.



A13327 30-31 Price Ea. \$ 1.25

Cowl Light Grommets

These grommets were used for '28-'29 only and go where the arms go through the panels.



A13324R 28-29 Price Pair \$ 3.80

Cowl Light Pigtails

Yellow with black tracer like the original, this wire goes through the socket and out the arm.



A13412 28-34 Price Pair \$ 3.50

Cowl Light Wire Supports

You'll need three of these to hold the cowl light cross over wire inside the firewall.

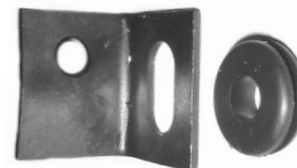

A14593 30-31 Price Set \$ 2.90

SEDAN

Give us your email address, confirmation and tracking info right at your fingertips!

Sedan63

Mike's "A" FORD-ABLE Parts

Cowl Light Wire Support

Or you can use three of these to hold the wires for the cowl lights and the wipers.

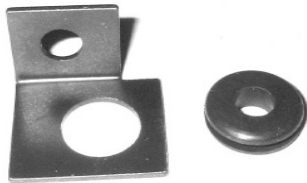

A14593A 28-29 Price Ea. \$ 2.25

Turn Signal Kit (6 Volt)

BE SAFE. Signal Stat. Add this complete turn signal kit directly to your tail lights. Kit includes the switch, fuse, flasher, flasher socket and complete instructions. Cowl conversion kit works with this one. If you do not have cowl lights you will need to install front turn signal lights of some sort. Comes with instructions. 11 Piece Set. For more turn signals items see our Turn Signal Section on **Page Sedan 72.**



A13310A 28-31 Price Set/11 \$ 58.95

Turn Signal Flasher

6-Volt flashers are hard to find; you'll need this if you have added turn signals to your A.



A13311 28-31 Price Ea. \$ 5.25

Complete Turn Signal Kit (6 or 12 Volt + or -)

Now you can have super bright Amber LED turn signals for your "A"! Kit includes super bright LED turn signals, stainless steel brackets, controller and wire. The easy hookup connects to 6 Volt OR 12 Volt cars with negative or positive ground without even flipping a switch. The kit features all solid state components (there are no turn signal flashers to wear out and the LED's will last for over 25 years!). The whole kit is bolted on so you don't have to permanently modify your car. Slim line turn signals mount to bumper clamp bolts and have a one wire hook up. Each turn signal is individually short circuit protected so if one wire shorts to the chassis, only that one light won't come on. Eliminate the short and the turn signal will work again. Also has a hazard light function and is backed by a one year manufacturer's warranty. 20 Piece Set.

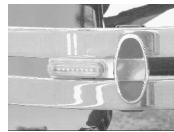
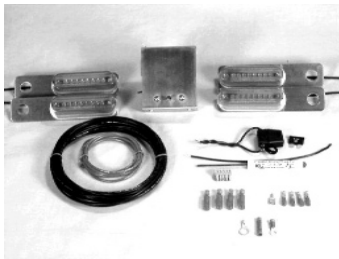

A13311A 28-31 Price Kit/20 \$ 169.95



1930 Fordor 3 Window

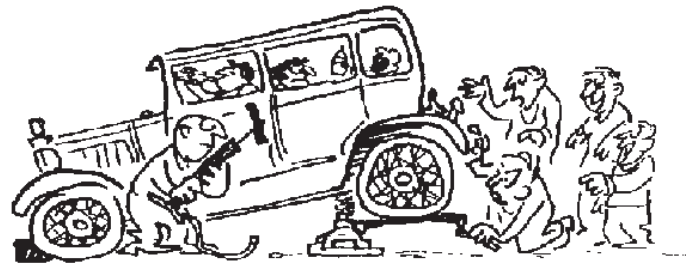

Has anybody got Bentley's Phone No.?

SEDAN

TAIL LIGHT

Specifications:

Parking, Tail: 3 CP, single contact Mazda 63
 Stop: 21 CP, single contact Mazda 1129

The following new parts are required to complete a restoration of your Tail Lights. This is only a guide - do not assume that this is all that is needed, all other parts need to be thoroughly checked.

1. Tail Light Rim - A13448SS
2. Tail Light Gasket Set - A13461
3. Replacement Screw Set - A13405SK
4. Lens - choose your style - A13450
5. Snap Rings - A13456
6. Licence Plate Lens - A13445
7. Retainer clips - A13446S
8. Tail Light socket Set -A13412S
9. Reinforcing Plate - A13463
10. Bracket to Fender Mounting Bolts - A13474B, SS
11. Tail Light Bracket/Fender Rubber Pad - A13520
12. Tail Light / Stop Light Bulbs - A13465 & A13466
13. Licence Plate Bolt - A13407MB
14. Stoplight Switch - A13480A or B

Duo-Lamp Tail Light Repair Parts

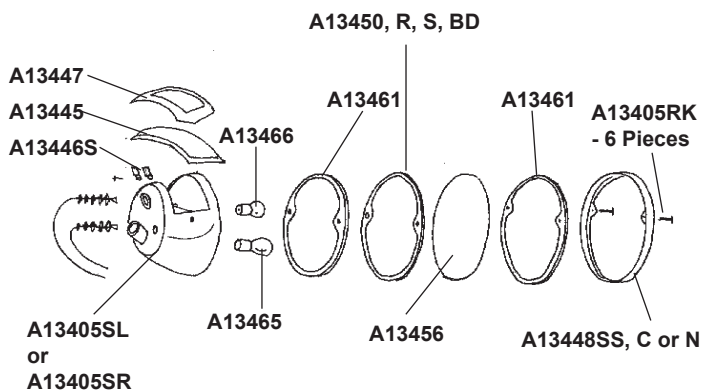

"Duolamp" Tail Light

Copy of the original. Stainless Steel. Commercials used black painted - left side has white lens - right side, no lens. Complete with half amber lens, bulbs and wiring - also includes bracket screws.

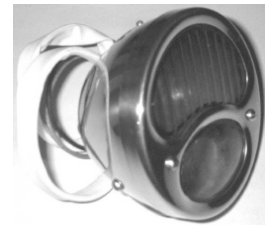

A13405SL	28-31	Left	Price Ea.	\$ 37.95
A13405SR	28-31	Right	Price Ea.	\$ 37.95

"Duolamp" Tail Light Replacement Screw Kit

This is all of the screws that you will need to refurbish your Tail light. 1 Set per Tail Light.



A13405SK	28-31	Price Set/8	\$ 3.65
----------	-------	-------------	---------

Stop Light Bulb

21 Candle Power.



A13465	28-31	Price Ea.	\$ 1.00
--------	-------	-----------	---------

Tail Light, Parking Light, Cowl, Instrument Panel & Dome Light Bulb

3 Candle Power as original.

10 Candle Power is available if you would prefer a brighter bulb.



A13466/3	3 CP	Price Ea.	\$ 0.90
A13466/10	10 CP	Price Ea.	\$ 1.25

Quartz Bulbs

If you want a lot more light, use these direct replacements for your original bulbs. These are also known as "Ugly Bulbs".



Tail Light and Parking: 20 Watt

B13466Q6	6 Volt	Price Ea.	\$ 13.75
B13466Q12	12 Volt	Price Ea.	\$ 11.00

Stop Light: 50 Watt

B13465Q6	6 Volt	Price Ea.	\$ 13.75
B13465Q12	12 Volt	Price Ea.	\$ 11.00

Mike's "A" FORD-ABLE Parts

Cowl & Tail Light Visor

Match up your Cowl & Tail Lights with a visor set. Just like the headlight set.



A13001A 28-31 W/Jewel Price Pair \$ 23.00

Tail Light Rim

We only keep the stainless as these will not rust.



A13448SS 29-31 Stainless Price Ea. \$ 5.75

LED Replacement Tail Light - All Red and Half Amber

Use this brand new product in your duo lamp housing and have the advantage of LED Tail lights. 6 or 12 Volt.

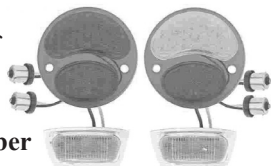

12 Volt
 A13453 Right - Half Amber
 A13453R Right - Red
 A13454 Left - Half Amber
 A13454R Left - Red Price Ea. \$ 40.00

6 Volt
 A13455 Right - Half Amber
 A13455R Right - Red
 A13457 Left - Half Amber
 A13457R Left - Red Price Ea. \$ 43.00

Tail Light All Red Lens

If your state does not allow amber stop lights, this all red lens is available.



A13450R 1928 - Sept. '29 Price Ea. \$ 5.25

Tail Light Half Amber Lens

This lens has a red section for the tail light and amber for the stop light.



A13450 Sept. '29 - till end '31 Price Ea. \$ 6.00

Tail Light Stop Lens

This is a glass red lens with the letters "STOP" molded in amber.



A13450S 29-31 Price Ea. \$ 8.95

Tail Light Blue Dot Lens

This is the all-red lens with the blue dot already installed in the stop section.



A13450BD 29-31 Price Ea. \$ 13.75

Tail Light Blue Dot

For the DIYer, you can fit your own blue dot in with this. It has a chrome rim. 1 Piece Set. Need 1 Set for one lens.



A13450D 28-31 Price Set \$ 4.95

Tail Light Snap Ring

This was used to hold the lens in the tail light rim. The sequence was the rim gasket, then the lens, then the snap ring.

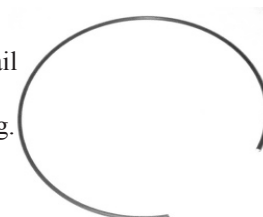

A13456 29-31 Price Ea. \$ 0.95

Tail Light Gasket

This goes between the face of the lens and the rim but many put one on both sides of the lens to reduce the risk of cracking.



A13461 29-31 Price Ea. \$ 0.50

License Plate Lens

This is the clear lens for the left side tail light to illuminate the license plate.



A13445 29-32 Price Ea. \$ 3.45

License Lens Gasket

This is the gasket for the clear license lens.



A13447 29-32 Price Ea. \$ 0.50

License Lens Retainer Clips

Two retainers and screws to hold the license lens in the tail light.

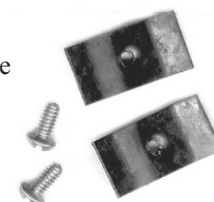

A13446S 28-32 4 piece set Price Set/4 \$ 1.50

SEDAN

Mike's "A" FORD-ABLE Parts

Tail Light Loom

This is what Ford used to protect the tail light wires from the elements. Extends from tail light through fender to under body.



A13412L 28-31 Price Ea. \$ 1.25

Tail Light Wire Clip

This clip holds the tail light loom to the fender.

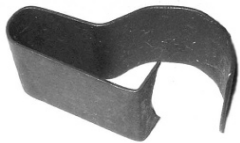

A14565 28-31 Price Ea. \$ 2.65

Tail Light Wire Clip

This clip holds the wire to the bottom side of the wood subrail. Includes one clip and wood screw. Used on 1928 - 1931 Fordors and 1928 - 1931 Station Wagons.



A14592 28-32 Price Set \$ 2.00

Tail Light Socket

Press this socket into the tail light bucket to hold the bulb.

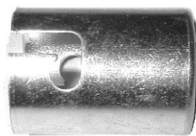

A13412S 29-31 Price Ea. \$ 0.65

Double Contact Socket

These universal style sockets are used to convert any lamp to a dual filament bulb that can be used for turn signals. Use staggered pin bulbs. Some modification to your lamp will be needed to accept these.



A13412DC 28-31 Price Ea. \$ 8.10

Tail Light Wire Pigtails

This pigtail with springs and washers extends out the back of the tail light to make your connection. Correct fabric and colors. Black for Taillight / Green for Stop Light.



A13412/13 29-48 Price Pair \$ 3.60

Tail Light Cross Over Wire

This cross-over wire allows you to add a right tail light and then connect the two tail lights to the main harness.



A14423XO 28-31 Price Set \$ 9.00

Tail Light Reinforcing Plate

Lessen the risk of damaging your fender by using this plate under the fender to attach your tail light bracket.

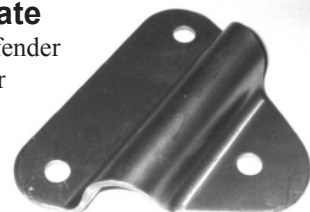

A13463 29-31 Price Ea. \$ 3.25

Tail Light Bracket Pad

Protect your fender from metal to metal vibration with this rubber pad which fits between the fender and the tail light bracket.



A13520 29-31 Price Ea. \$ 2.00

Tail Light Bracket

These brackets are ready to mount. Same gauge steel Ford used. Used with teacup style tail lights.



A13471R	29-31	Right	Price Ea.	\$ 9.85
A13471L	29-31	Left	Price Ea.	\$ 9.85
A13471RC	29-31	Right - Chrome	Price Ea.	\$ 13.95
A13471LC	29-31	Left - Chrome	Price Ea.	\$ 13.95

Tail Light Bracket Bolts

This set of 3 special carriage bolts and nuts is used to bolt the tail light bracket to the fender. Bolts have large heads. 3 X 1/4-20 5/8 Bolt with Large Head. Not used on 1928 Tudors.



A13474BK	29-31		Price Set/6	\$ 1.75
A13474SS	29-31	Stainless steel	Price Set/9	\$ 3.25



1928 Tudors.				
A13469X	1928		Price Set	\$ 0.95

Give us your email address, confirmation and tracking info right at your fingertips!

Sedan67

SEDAN

Mike's "A" FORD-ABLE Parts

Rear License Bracket

An identical reproduction of the original.

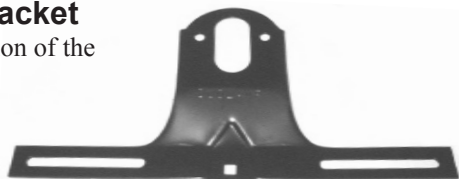

A13406D 28-31 Price Ea. \$ 6.50

A13406SS 29-31 Polished Stainless Steel
Price Ea. \$ 15.95

Rear License Plate Special Bolts

The nuts and bolts necessary to mount your license plate.



A13407MB 28-31
Price Set/4 \$ 4.35

License Plate Reflector Bolts

A reproduction of an aftermarket accessory. These bolts are sold in pairs and available in four different colors.



A13408 Blue
A13409 Amber
A13410 Green
A13411 Red
Price Pair \$ 1.00

Stop Light Switch

The early A's used this type switch which mounted on the transmission. Don't forget to order your link A13507R. Best Quality.



A13480A 28-30 Price Ea. \$ 5.95

Stop Light Switch Link

This is the metal link for the A13480A stop light switch.



A13507R 28-29 Price Ea. \$ 1.45

Stop Light Switch

A few '29's had this but mostly for '30-'31's. This bolts to the cross member of the frame. Needs A2465B (Page Gen. 50) Pedal to Brake shaft rod. Best Quality.

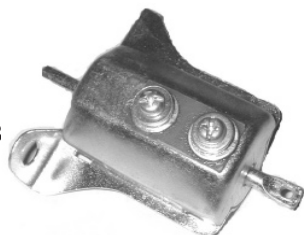

A13480B 30-31 Price Ea. \$ 5.00

Stop Light Switch Mounting Bolts

Here are the bolts, nuts, and lock washers to mount the '30-'31 style stop light switch to the cross member.

2 - 1/4-20 x 1/2" Bolts,
lockwashers and nuts.



A13480MB 30-31
Price Set/6 \$ 0.55

1928 / 1929 Stoplight Switch Mounting

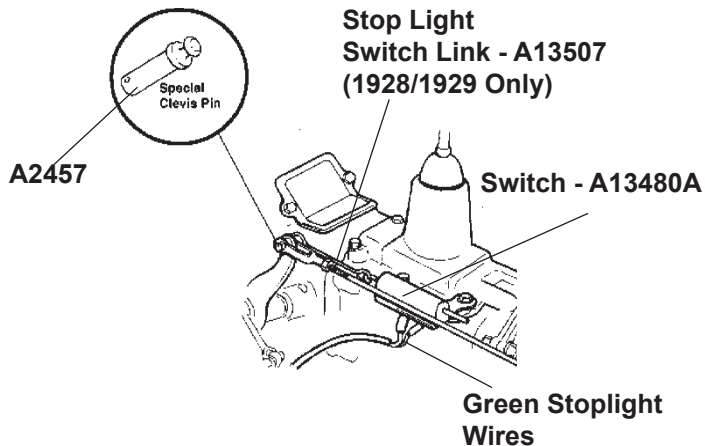

1930 / 1931 Stoplight Switch Mounting

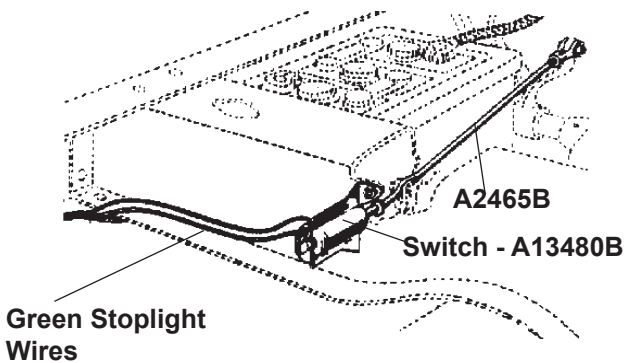

Thanks to Les Andrews for the use of his drawings.

See Page Sedan 72 for the complete Turn Signal Section.

Mike's "A" FORD-ABLE Parts

Custom LED Third Brake Lights

Made in USA. Custom LED Third Brake Light fits in the back window of cars and trucks. Strong, twin suction cups attach the rugged, black ABS case to the glass in the back window. Two wire, easy hookup works with 6V or 12V negative or positive ground vehicles. Electronics feature all solid state components (nothing to wear out and the LEDs should last for over 25 years!). No permanent modifications to your car are required. Kit comes with Third Brake Light, harness, connectors, mounts, and suction cups. Logo Lites Custom LED Third Brake Lights are backed by a one year manufacturer's warranty.



A13312S	STOP	Price Kit	\$ 72.00
A13312A	1928	Price Kit	\$ 72.00
A13312B	1929	Price Kit	\$ 72.00
A13312C	1930	Price Kit	\$ 72.00
A13312D	1931	Price Kit	\$ 72.00

A custom Third Brake Light is available. Any 4 Characters of your choice is available, eg MIKE.

A13312O	Special 4	Price Kit	\$ 99.65
---------	-----------	-----------	----------

Do you like the
sound of FREE
Shipping??

Order online
and get a 5%
Discount -
this could cover
your shipping
costs!!

DRUM TAIL LIGHT

Stop Light Bulb

21 Candle Power.

See Quartz Bulbs on Page Sedan 65.

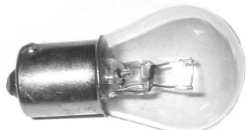

A13465 28-31 Price Ea. \$ 1.00

Tail Light, Parking Light, Cowl, Instrument Panel & Dome Light Bulb

3 Candle Power as original.

10 Candle Power is available if you would prefer a brighter bulb.



A13466/3 3 CP Price Ea. \$ 0.90
A13466/10 10 CP Price Ea. \$ 1.25

Complete Drum Tail Light

Top quality reproduction with the black bracket and nickel body. Used on '28's and early '29's.

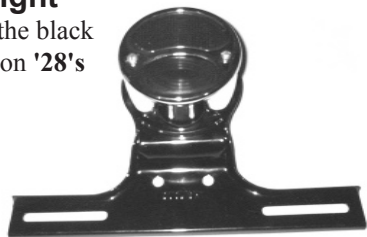

A13405DPL - Passenger - Left - Nickel Ea. \$ 110.00
A13405DPR - Passenger - Right - Nickel Ea. \$ 110.00

1) Assemble contact-insulating washers and rivets. Seat down & upset rivet so that contact can be rotated.

2) Assemble divider plate using 3/16" rivets.

3) To install backing plug; tap into hole from front with slot turned clockwise until slot is level with plate.

Rotate contact and plug so contact

enters small slot in brass plunger. When aligned tap in until locking plunger enters hole in rear of plate.

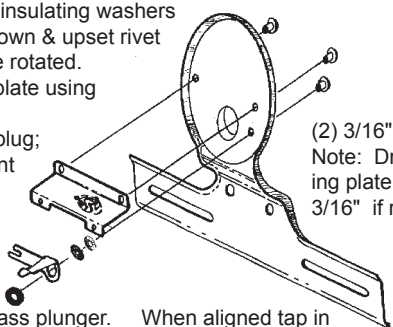

(2) 3/16" Rivets
Note: Drill backing plate 3/16" if required.

Drum Tail Light License Bracket

Top quality steel reproduction.

Paint Black.



A13406AR 28-29 Price Ea. \$ 28.50

Drum Tail Light and License Bracket to Support Bracket Bolts



Two 5/16-24 x 11/16 Hex Bolts, L/w's and Nuts.

A13607 28 - Early '29 Price Set \$ 0.50

Drum Tail Light Support Bracket to Body Bolts



Two 5/16-24 x 5/8 Hex Bolts and L/w's.

A13673 28 - Early '29 Price Set \$ 0.50

Drum Tail Light Bracket

These brackets were mounted onto the rear sub-frame of the body for the drum tail lights to mount onto.

Originally were only used on the left, so you will have to drill the right sub-frame to mount the right.

Used on the Sedans.



A13473AL 28-29 Left Price Ea. \$ 22.50
A13473AR 28-29 Right Price Ea. \$ 22.50

Drum Tail Lamp Socket

This is the bulb socket for the '28-'29 drum tail light.

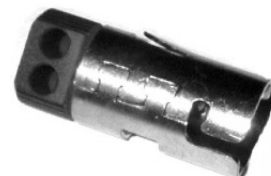

A13410A 28-29 Price Ea. \$ 34.98

Drum Tail Light Divider Plate

This divider plate separates the tail lamp from the stop lamp sections on the drum style tail light.

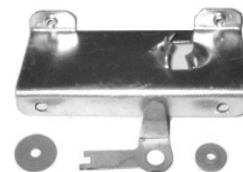

A13406DP 1928 - Early 1929 Price Set \$ 21.75

Drum Tail Light Body

This is a very good nickel-plated reproduction. Body only.



A13440DBPL - Passenger - Left - Nickel
A13440DBPR - Passenger - Right - Nickel
1928 - Early '29 Price Ea. \$ 31.00

Mike's "A" FORD-ABLE Parts

Drum Retainer Screws

This is the special hardware necessary to hold the tail light body and lens on.



A13441BT 28-29

Price Set/6 \$ 5.75

Drum Stop Face Plate

This steel insert with the word "STOP" fits behind the red lens.



A13442AR 1928 - Early '29

Price Ea. \$ 6.30

Drum White License Lens

For the '28 drum tail light only.

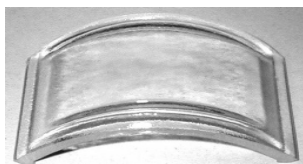

A13445AR 1928 - Early '29 Price Ea. \$ 10.00

Drum Retainer Clips

Two retainers and screws to hold the license lens in the drum tail light.

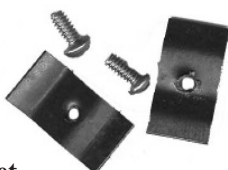

A13446S 28-31 4 piece set

Price Set/4 \$ 1.50

Drum License Lens Gasket

This is the gasket for the '28 license lens on the drum tail light.



A13447AR 1928 - Early '29 Price Ea. \$ 0.75

Drum Red Lens

This is an all-red lens for the '28 drum tail light.



A13450AR 28-29 Price Ea. \$ 7.60

Drum Tail Light Lens Gasket

This is the round gasket for the drum tail light.



A13461AR 1928 - Early '29 Price Ea. \$ 0.60

Drum Tail Light Wire Clip

You'll need two of these to hold the wire to the tail lamp bracket on the '28 drum tail light.



A14595 1928 - Early '29 Price Pair \$ 2.95

Drum Tail Light Extension Wire

This wire goes from the drum tail light to the main wiring harness.

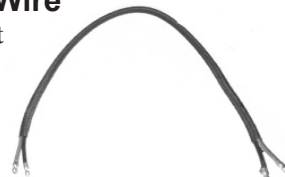

A14423AR 28-29 Price Ea. \$ 5.65

Order Online Now and Save 5%

Visit our website for all your Model "A" needs.



www.mikes-afordable.com

SEDAN

Give us your email address, confirmation and tracking info right at your fingertips!

Sedan71

TURN SIGNALS

Turn Signal Kit (6 Volt)

BE SAFE. Signal Stat. Add this complete turn signal kit directly to your tail lights. Kit includes the switch, fuse, flasher, flasher socket and complete instructions. Cowl conversion kit works with this one. If you do not have cowl lights you will need to install front turn signal lights of some sort. Comes with instructions. 11 Piece Set.



A13310A 28-31 Price Set/11 \$ 58.95

Turn Signal Flasher

6-Volt flashers are hard to find; you'll need this if you have added turn signals to your A.



A13311 28-31 Price Ea. \$ 5.25

Turn Signal Lamps

If you are using the A13310A Turn Signal Kit these are the turn signal lights that will fit between the front and rear bumper bars. No modifications needed. Don't forget to buy extra wire by the foot see wiring section on Page Gen. 198. Available for both 6 & 12 Volts. Use on front and rear.

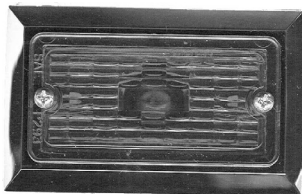

A13405T6	6 Volt - Amber	Price Ea.	\$ 20.95
A13405T6R	6 Volt - Red	Price Ea.	\$ 20.95
A13405T12	12Volt - Amber	Price Ea.	\$ 19.95
A13405T12R	12 Volt - Red	Price Ea.	\$ 19.95

LED Replacement Tail Light - All Red or Half Amber

Use this brand new product in your duo lamp housing and have the advantage of LED Tail lights. 6 or 12 Volt.

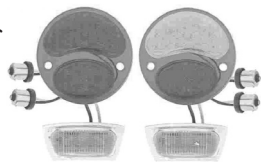

12 Volt			
A13453	Right - Half Amber		
A13453R	Right - Red		
A13454	Left - Half Amber		
A13454R	Left - Red	Price Ea.	\$ 40.00
6 Volt			
A13455	Right - Half Amber		
A13455R	Right - Red		
A13457	Left - Half Amber		
A13457R	Left - Red	Price Ea.	\$ 43.00

Complete Turn Signal Kit (6 or 12 Volt + or -)

Now you can have super bright Amber LED turn signals for your "A"! Kit includes super bright LED turn signals, stainless steel brackets, controller and wire. The easy hookup connects to 6 Volt OR 12 Volt cars with negative or positive ground without even flipping a switch. The kit features all solid state components (there are no turn signal flashers to wear out and the LED's will last for over 25 years!). The whole kit is bolted on so you don't have to permanently modify your car. Slim line turn signals mount to bumper clamp bolts and have a one wire hook up. Each turn signal is individually short circuit protected so if one wire shorts to the chassis, only that one light won't come on. Eliminate the short and the turn signal will work again. Also has a hazard light function and is backed by a one year manufacturer's warranty. 20 Piece Set.

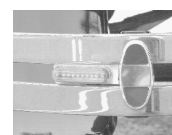
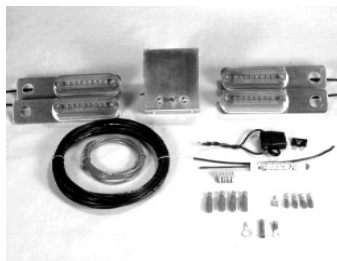

A13311A 28-31 Price Kit/20 \$ 169.95



1931 Tudor Sedan

DASH & DOME LIGHT

Specifications:

Instrument Panel:	3 CP, single contact, Mazda 63
Dome:	3 CP, single contact, Mazda 63
Commercial Dome:	15 CP, single contact, Mazda 87

Dash Light

This mounts in the middle of the dash on the '28-'30 A's with the oval speedometer. Attach the dash wire to the charge post on the amp meter.



A13708AR 1928 - June 1930 Price Ea. \$ 22.55

Dash, Dome, Cowl & Parking Light Bulb

3 Candle Power as original.
10 Candle Power is available if you would prefer a brighter bulb. See Page Sedan 65 for Quartz Bulbs.



A13466/3	3 CP	Price Ea.	\$ 0.90
A13466/10	10 CP	Price Ea.	\$ 1.25

Dash Light Cover

This is the cover only for the dash light on the '28-'30 oval speedometer. Only fits repro Dash light.



A13705 28-30 Price Ea. \$ 13.70

Dash Light Bracket

If your dash light mounts up under the dash, you'll need one of these brackets.



A13706BRC	30-31	Closed car.	Price Ea.	\$ 1.95
A13706BRO	30-31	Open car.	Price Ea.	\$ 1.55

Dash Lamp Cap Only

For Open and Closed Cars. Switch Type.

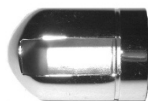

A13705B 30-31 Price Ea. \$ 13.50

Dash Light (Excellent Replacement)

This is the dash lights for the '30-'31 A's with the round speedometer; this mounts under the dash rail. See A13710 for dash light armored cable.

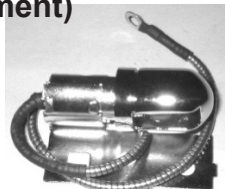

A13708B June '30 - till end '31 Closed Car Price Ea. \$ 24.15

Dash Light Armored Cable

This 1/8" diameter single strand cable is used for the dash light but can also be used for a sport light. Cut and sold in 12" lengths.

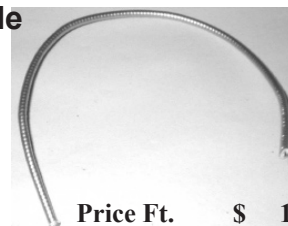

A13710 28-31 Price Ft. \$ 1.65

Dome Light Assembly (With Switch)

This is the dome light with switch. 6 Volt bulb installed.

28-31 Std Fordors,
1931 Deluxe Tudor &
1931 SW Fordor A160A.



A13771WS 30-31 Price Ea. \$ 49.50

Dome Light Switch on Rim

A copy of the original switch and lever that's located on the rim of the round Dome Light (A13771).



A13771SW 28-31 Price Ea. \$ 14.95

Dome Light Assembly (Without Switch)

Same unit as A13771WS except this has no switch. You will have to purchase A13770 (Page Sedan 74) Cover and A13769 (Page Sedan 74) Switch and A13778 Wire - below.



A13771 30-31 Price Ea. \$ 45.65

Dome Light Snap Ring

This little cadmium plated ring can be hard to find but you'll need it to hold the lens onto the dome light.

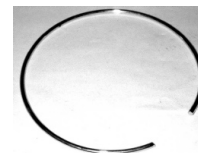

A13771C 30-31 Price Ea. \$ 5.50

Dome Light Lens

Milky-colored replacement lens for the round dome light. Fits A13771WS.



A13771G 30-31 Price Ea. \$ 8.50

Dome Light Wire

This is the correct 16 gauge cloth covered wire; black with a blue tracer. Order per foot needed for your vehicle. Wire starts at the drivers side of the terminal box, up the windshield post, half way across the header and back to the dome light. Make sure you run a ground wire from the light to the side of the body.



A13778 Price Ft. \$ 0.65

Mike's "A" FORD-ABLE Parts

Dome Light Switch and Cover

This replacement switch with cover mounts on the door pillar.



A13770 28-31 Cover Price Ea. \$ 2.75

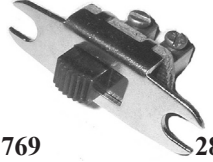

A13769 28-31 Switch Price Ea. \$ 8.75

See Page Gen. 198 for Wire - Sold by the Foot.

See Page Gen. 189 for Ignition Switch, Instrument Panels & Parts.

If you look very carefully you can see the original "State Asylum" Emblem on this old Fordor. Boy if this car could talk!! The Fordor is owned by Mr. P. Brown, of Commerce, GA.



SEDAN

GARNISH MOLDINGS & FRAMES

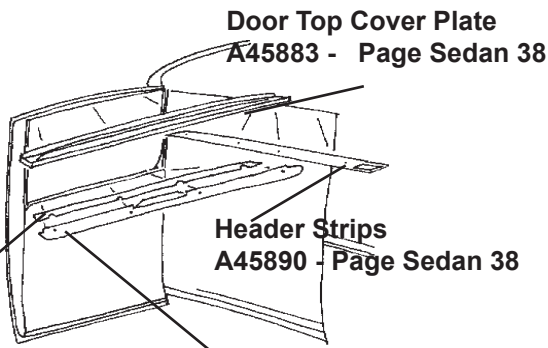

Door Top Cover Plate
A45883 - Page Sedan 38

Header Strips
A45890 - Page Sedan 38

Upper Door Seal
A19008 - Page
Sedan 37

Garnish Molding
A842, A342 & A442
- below

Steel Garnish Molding

These steel reproduction garnishes are really good quality.



A342A	28-29	Tudor - 26 15/16"	Price Pair	\$ 80.00
A442B	30-31	Tudor - 27 7/16"	Price Pair	\$ 80.00
A442ABR	28-31	Tudor Rear - 37"	Price Pair	\$ 83.00

Garnish Moldings

The **Slant Windshields** both had attractive garnish moldings under the regular garnish at the bottom of the window. This steel reproduction is quite nice.



A542BFD	1931	Front doors - Slant windshields	Price Ea.	\$ 75.00
A542BRD	1931	Rear doors - Slant windshields.	Price Ea.	\$ 78.00
A542BQ	1931	Quarter windows. Slant windsh.	Price Ea.	\$ 65.00

Garnish Molding Screws

These screws are 10/32 x 1/2 to attach the garnish molding to the door.



A342S	28-31	Price Ea.	\$ 0.15
-------	-------	-----------	---------

Windshield Header Garnish

The **Slant Windshields** both used this garnish above the windshield. It's also known as the header upholstery retainer. Primed and ready to paint.



A542	30-31	Price Ea.	\$ 89.95
------	-------	-----------	----------

Door Pull Handle

This door pull handle comes complete with hardware to attach to the window molding on the **Fordors**.



A61062CR	29-31	Price Ea.	\$ 8.65
----------	-------	-----------	---------

Rear Window Frame

Steel window frames, exact copy of Fords from the Ford Blue Prints are now available for the following vehicles:



'28-'31 Tudor Sedan			
'29-'31 Fordor Sedan			
'29-'31 Town Sedan - Briggs 155B & D			
'29-'31 Std. Fordor - Briggs 154B & D			
'29-'31 Std. Fordor - Briggs 170A & B			
1929 Fordor - Briggs 60C			
A47096A	28-31	Price Ea.	\$ 79.50

Rear Window Screws

Hold your window frame in place with this Set of Twelve #10 x 1 Oval Chrome Plated Wood Screws.



A48251	28-31	Price Set	\$ 1.20
--------	-------	-----------	---------

Garnish Retainer Clip

The '28-'31 **Tudor Sedan** used these clips on the rear side windows (quarter window) on the top rear corners to hold the garnish molding in place.



Need 2 per car.

RAR209	28-31	Price Ea.	\$ 5.50
--------	-------	-----------	---------

Tube Nuts

#6-32". Made in the USA. You'll need three tube nuts per door to mount the window garnish molding on the **Briggs Straight Windshield Sedans**.



A45484	Set of 6	Price Set	\$ 3.55
--------	----------	-----------	---------

#8-32". Made in the USA. You'll need ten of these tube nuts per door to mount the window garnish molding on the **Slant Windshield Sedans**. These are included in the trim kits.



A45483T	Set of 10	Price Set	\$ 4.50
---------	-----------	-----------	---------

Give us your email address - order confirmation and tracking info at your fingertips!

Sedan75

Mike's "A" FORD-ABLE Parts

SILL PLATES

Sill Plates

These die stamped aluminum sill plates with the Ford script fit under the door.



A46480BS 28-31 Tudor 19 1/2"
 Price Pair \$ 19.50

Zinc Sill Plates

These are authentic zinc sill plates like Ford originally used.



A46480BOR 28-31 Tudors 19 1/2"
 Price Pair \$ 31.00

Sill Plate Screws - Tudor

Four screws will mount the Tudor sill plates; you'll need 2 Sets for a Tudor. #10 x 1/2" Screws.



A46480MB 28-31
 Price Set/8 \$ 0.65

Murray Sill Plates

Mike has these complete sets of sill plates for the '29-'31 Murray Fordor Sedans A165A, B, C, in both plain and etched design. Most were etched.

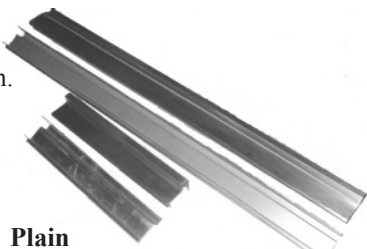

A46480M 30-31 Plain Price Set/4 \$ 130.00
 A46480MD 29-31 Etched (Deluxe) Price Set/4 \$ 139.00

Briggs Sill Plates (Straight Window)

These are for the Briggs Fordor Sedans Only. The only difference between '28-'29 and '30-'31's are that the '30-'31's are etched with Ford Logo.



A46480CS	28-29	Front Plain	Price Pair	\$ 41.80
A46481CS	28-29	Rear Plain	Price Pair	\$ 27.80
A46480DS	30-31	Front Etched	Price Pair	\$ 63.75
A46481DS	30-31	Rear Etched	Price Pair	\$ 43.95

Slant Windshield Fordor Sill Plates

Mike also has this complete set of sill plates for the front and rear of the Slant Windshield Fordors.

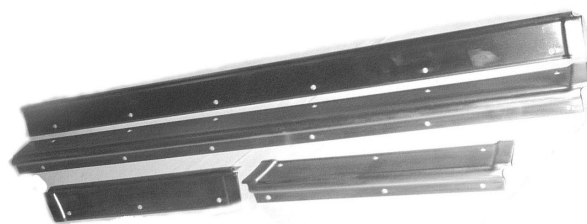

A46480SW 1931
 Price Set/4 \$ 136.00

Sill Plate Screws - Fordors and S/W's

This set of 36 # 8 x 3/8 pan head screws are what you need for all Slant Windshield cars. Zinc plated.



A46480S 1931 Price Set/36 \$ 3.75

Door Sill Panel

This metal strip is nailed to the wood subrails on Fordor Sedans



A48696 30-31 Price Ea. \$ 46.95

Mike's "A" FORD-ABLE Parts

Sill Plate Screws for Wood Subrails

The complete set of screws that secure the Sill Plates to the wooden sub-rails.
Zinc Plated.



Original Sills used #8 x 3/4
A48676A 28-31

Price Set/38 \$ 3.75



Repro Sills used #6 x 3/4
A48676B 28-31

Price Set/38 \$ 2.80

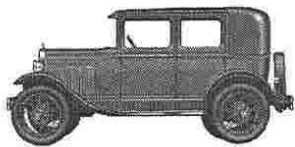

1929 STEELBACK FORDOR
(60-C)

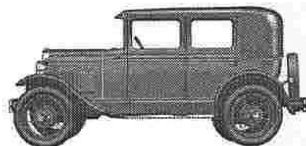

1930-31 2-WINDOW FORDOR
(60-A,B)

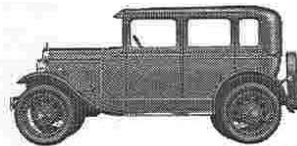

1929-31 3-WINDOW FORDOR
(BRIGGS) (155-1B,D/165B,D)

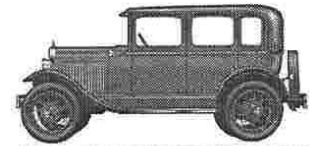

1929-31 3-WINDOW FORDOR
(MURRAY) (155-1A,C/165A,C)



1930-31 SLANT WINDSHIELD
FORDOR (160-A,B,C)

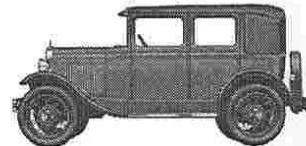

1928-29 LEATHERBACK FORDOR
(60-A,B)

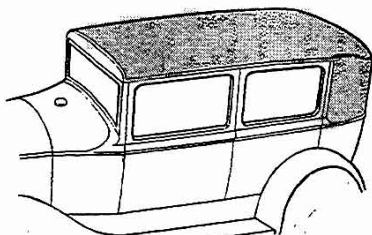

1928-29 "60" A-B
LEATHERBACK
4 DR SEDAN

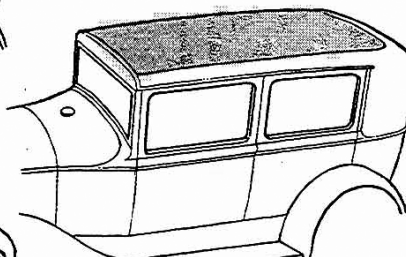

1929-30-31 "170" A-B
2 WINDOW
4 DR SEDAN

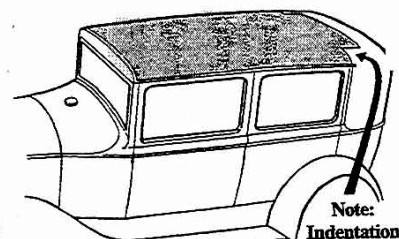

1929 "60" C
STEELBACK
4 DR SEDAN

Note:
Indentation

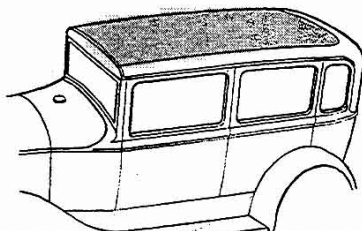

1929-30-31 "155"-165" A, B, C, D
3 WINDOW
4 DR SEDAN

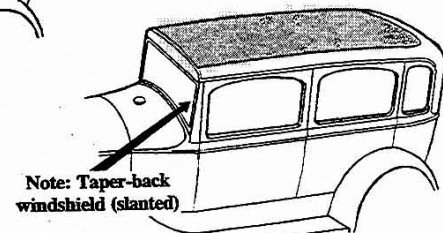

1931 "160"
SLANT WINDOW
4 DR MURRAY SEDAN

Note: Taper-back
windshield (slanted)

Give us your email address - order confirmation and tracking info at your fingertips!

Sedan77

SEDAN

SEAT PARTS

Seat Adjuster Installation

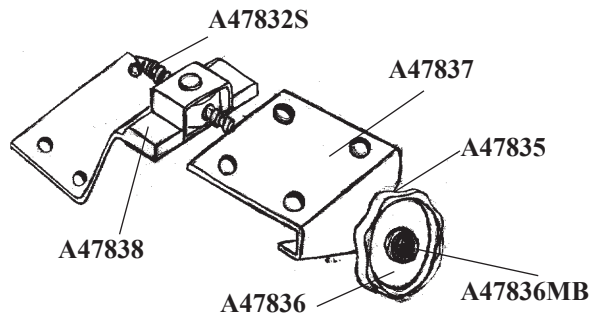

Seat Adjuster Bolt & Nut Assembly

This style used on the '29-'31 Murray Fordor to adjust the front seat. Used on the 155A & C, 165A & C. 19 1/16" Long.



A63534AR 29-31 Price Set \$ 69.95

Seat Adjuster Bolt

This special threaded bolt is used to adjust the screw-type adjustable seat, by moving it backwards or forwards. The seat adjuster nut (A47832N) goes on this. Original Screws will not fit repro. nuts, its best to replace the bolt and nut. 5 1/2" Long.

Used on:
'29-'31 Fordor and Town Sedans



A47832S 30-31 Price Ea. \$ 18.95

Seat Adjuster Nut

This is the special round nut. Used on: '29-'31 Fordor and Town Sedans. This nut will only fit the repro screw-A47832S.



A47832N 30-31 Price Ea. \$ 12.95

Seat Adjuster Washer

This washer goes on the head of the seat adjuster bolt before the bolt goes through the bracket at the front of the seat. This washer is made of nylon for smoother operation, not brass like the original.

Used with the A47832S.

A47835 30-31



Price Ea. \$ 1.80

Seat Adjuster Knob

This chrome-plated round knurled knob is for the front seat adjustment.

Used on:
'29-'31 Fordors
'29-'31 Town Sedan

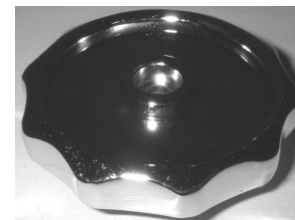

A47836 29-31 Price Ea. \$ 14.35

Seat Adjuster Handle

This brass chrome-plated style handle was used on:

1931 Slant Windshield Fordors,
1931 Deluxe Tudors

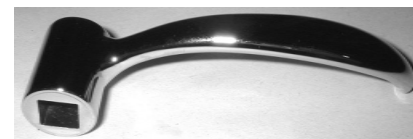

A47836B 30-31 Price Ea. \$ 12.95

Seat Adjuster Handle Screw

This screw holds the round seat adjustment knob A47836 to the seat adjustment bolt A47832S.

A47836MB 30-31



Price Ea. \$ 0.70

Seat Adjuster Bracket

Mounts onto the bottom of the wood frame. This holds the seat adjusting screw in place, so that seat can be moved back and forth. Used on some 1930 - Mid 1931 Town Sedans and Fordors.

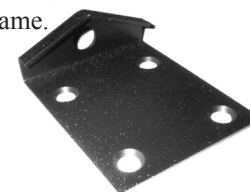

A47837 1930 - Mid 1931 Price Ea. \$ 26.95

SEDAN

Mike's "A" FORD-ABLE Parts

A47836B Seat Adjuster Installation

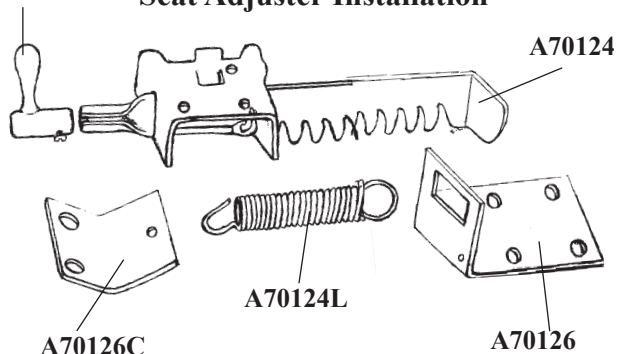

Seat Adjuster Bracket and Nut

An "L" shaped bracket that is located on the body cross member and extends up the front seat frame. A47832N is installed. For the screw type seat adjuster. Used on some 1930 to mid 1931 Fords.



A47838 1930 - Mid 1931 Price Set \$ 51.95

Seat Adjuster

A saw-tooth style seat adjuster. Mounting bracket is at the front of the seat. Mounting bracket to the floor is not included. See A70126, A70126C. Used on: 1930 - '31 Fordor

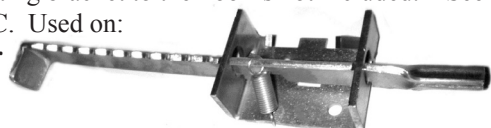

A70124 1931 Price Ea. \$ 63.00

Seat Adjuster Spring

This 6" spring is used with the saw-tooth style adjuster - A70124.



A70124L 1931 Price Ea. \$ 4.40

Seat Stop Block

Attach this block to the bottom of the wood that the cushion spring is upholstered to. When the spring is in position the block sits just behind the front edge of the seat riser to keep the cushion in place. Used on several '28 - '29 Tudor and Fordor Rear Cushions.



RAR205 28-29 Price Ea. \$ 10.50

Front Seat Rear Adj. Bracket Guide

This bracket was used on the Front Seat of the Murray Town Sedan Only.



RAR251 28-31 Price Pair \$ 13.95

Seat Leg

Use these brackets for the front bucket seats to pivot on. These mount to the floor of Tudor Sedans. Cast "S" shaped stud with an eye opening on the seat end. Threaded on the opposite end and goes through the cross channel to secure to the body. Need 2 per seat.

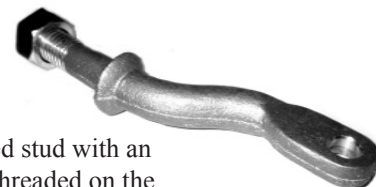

A47902 28-31 Price Ea. \$ 16.50

Tudor Seat Leg - Offset

These are the same as the A47902, but have an extra 2" offset in them to give you more leg room on your Tudor Sedan.



A47902EXT 28-31 Price Pair \$ 36.00

Seat Hardware Kit

One of these kits does one bucket seat on your Tudor. Includes pivot brackets and seat cups.



This is the replacement set. For the original see A47902.

A47903S 28-31 Price Kit \$ 8.00

Seat Rest Cups

Mike has these cups separately if that's all you need. They go on the rear of the front bucket seat assembly.



A47903 28-31 Price Ea. \$ 2.00

Seat Adjuster Kit

These replace the front seat legs on the Tudor Sedan and enables the seats to be adjusted forward and backwards, as well as up and down. Gives you approx. 6" more leg room. 1 Kit is enough for 1 seat.

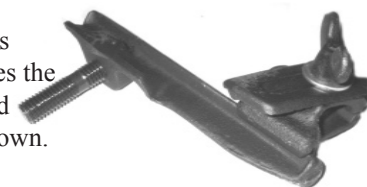

A47904 28-31 Price Set \$ 124.95

Tudor Seat Pivot Pin

This pin connects the seat to the pivot stud. Includes cotter pin. Need 2 sets per seat. One set has one Pivot Pin and One cotter Pin.



A90538 28-31 Price Set/2 \$ 0.90

Seat Tacking Strip

Rivets are included to mount this strip of wood onto the backrest frame of your Tudor Sedan front buckets. Tacks hold the upholstery to this strip.

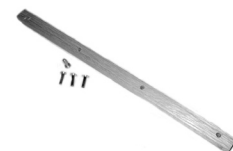

A47905 28-31 Price Each \$ 4.95

Mike's "A" FORD-ABLE Parts

Seat Latch Assembly

This is the bracket for the saw-tooth style seat adjuster. Mount it to the floor under the front of the seat. Used on **Deluxe Tudor** and **Slant Windshields**.



A70126 1931 Price Ea. \$ 28.00

Front Seat Swivel Bracket

Passenger Side for Late **1931 Tudor**, made from heavy gauge steel, to original specs. Original prints for seat parts specify black enamel for some components and lacquer to match trim on others.

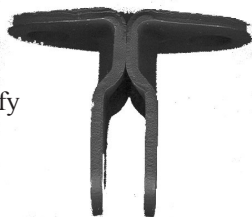

A57697 1931 Price Pair \$ 15.90

Seat Spring Clip

This clip holds the adjuster spring on the saw-tooth seat adjuster. It screws into the back bottom edge of the front seat assemblies. Used on **Deluxe Tudor**.



A70126C 1931 Price Ea. \$ 11.00

Seat Cushion Dowel

Holds seat cushion onto the body subrail so that cushion (springs) will not move. Need 2 per seat.

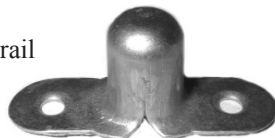

A121D 28-31 Price Ea. \$ 10.25

Slant Windshield Backrest Clips

These clips attach to the body using the same bolts that bolt the rear center body section in place towards the bottom. They keep the bottom of the rear backrest in place. Used on **Slant Windshield Fordor Sedans**.



RAR204 1931 Price Pair \$ 13.95

Rear Seat Mounting Clip Set

A complete set of clips to mount the rear seat on a **1931 Slant Windshield Town Sedan**.



RAR229 1931 Price Set/4 \$ 16.95

Seat Track Assembly

This is the slide track with 4 seat studs for the **'30-'31 Fordors**. Read Vol. 3 How To Restore.

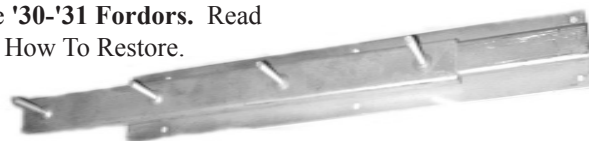

A84841BR 30-31 Price Set/4 \$ 57.60

Seat Track Assembly

This is the slide track with 3 seat studs for the **'30-'31 Deluxe Tudor Sedan**.



A84842BR 30-31 Price Set/4 \$ 57.60

Seat Armrest Kit

This kit gives you both back seat side armrests for the **Fordor Sedans**.

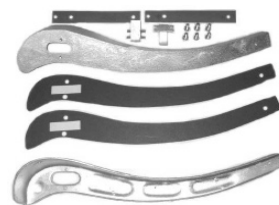

A56666PR 28-34 Price Kit \$ 76.65

Seat Armrest Brackets

This pivot bracket is used to mount the center armrest on the **Fordor Sedans**.



A56642BR 28-31 Price Kit \$ 69.95

Rear Floor Pan Spring Hump Cover

Originally Ford used roof material to cover the hump on the rear floor pan. Used on: **1931 Town Sedan**.



A85456C 1931 Price Ea. \$ 4.50

Rear Floor Pan Spring Hump Straps

This 4 piece set of metal straps hold the cover **A85456C** in place over the spring hump.

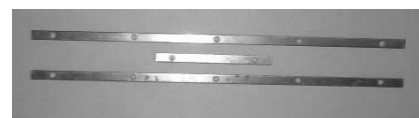

RAR220 1931 Price Set/4 \$ 23.45

SEDAN

SEAT SPRINGS

28-31 Tudor Sedan

S400	Front Cushion (2 req.)	\$ 43.75
S401	Front Backrest (2 Req.) Each	\$ 42.00
S402	Rear Cushion	\$ 70.75
S403	Rear Backrest	\$ 64.25
S403A	Rear Backrest - Early 1928	\$ 76.25

28-29 Briggs - Fordor Sedan Leather Back & Steel Back - 2 Window Body Style

S500	Front Cushion	\$ 76.50
S501	Front Backrest	\$ 66.75
S502	Rear Cushion	\$ 82.75
S503	Rear Backrest	\$ 74.00

1929 Briggs & Murray - Standard Fordor Sedan - 3 Window Body Style

S500	Front Cushion	\$ 76.50
S501	Front Backrest	\$ 66.75
S510	Rear Cushion	\$ 76.00
S511A	Rear Backrest - 1 Piece	\$ 115.00

30-31 Briggs & Murray-Standard Fordor Sedan

S516	Front Cushion	\$ 74.50
S517	Front Backrest	\$ 67.75
S518	Rear Cushion	\$ 76.50
S519A	Rear Backrest - 1 Piece	\$ 95.75

1929 thru Early 1931 - Briggs & Murray - Deluxe Town Sedan

S516	Front Cushion	\$ 74.50
S517	Front Backrest	\$ 67.75
S518	Rear Cushion	\$ 76.50
S519	Rear Backrest - 3 Pieces	\$ 95.75

1931 Briggs & Murray - Slant Windshield Fordor Sedan

S520	Front Cushion	\$ 74.00
S521	Front Backrest	\$ 67.50
S522	Rear Cushion	\$ 74.25
S523	Rear Backrest	\$ 75.25

Upholstery

Due to the enourmous color selections and choices the upholstery section has been left in the "General Parts & Running Chassis" Section - See Page Gen. 220.

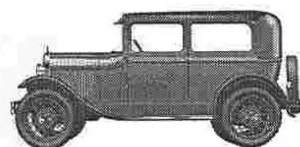

1928-29 TUDOR SEDAN (55-A)

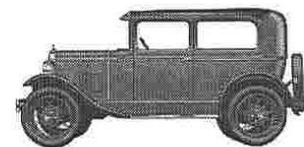

1930-31 TUDOR SEDAN (55-B)

SEDAN

Mike's "A" FORD-ABLE Parts

Notes

Notes

SEDAN

Mike's "A" Ford-able Parts

124 Model A Drive
Maysville, GA 30558

Phone: (706) 652-3866 Fax: (706) 652-2492

E-Mail - mike@mikes-afordable.com

Order Form

Date: _____ Year & Body Style of Car _____

Customer Information	Shipping Address (if different) No P.O. Boxes
Name _____	Name _____
Phone (_____) _____	Phone (_____) _____
Address _____	Address _____
City _____	City _____
State _____ Zip _____	State _____ Zip _____
Email _____	Email _____

Quantity	Part #	Description	Price Each	Total Price

Would you like to have a copy of your invoice e-mailed to you? Have your shipping date and tracking information right at your fingertips. Please be sure to print your e-mail address clearly. _____			
Method of Payment _____ Check or Money Order _____ Visa _____ Master Card _____ Discover		GA Residents add 7% Tax See formula in The Fine Print	Total
Acct # _____ Expiration Date _____ 3 Digit Security Code / Rear _____			Tax
			Shipping
			Total Enclosed

Give us a call - 1-888-TRY-MIKE (879-6453) **Have an "A" Day!**

Mike's "A" Ford-able Parts

Quantity	Part #	Description	Price Each	Total Price

Sub
Total

GA Residents add Tax

See formula in The Fine Print

Tax

Shipping

Total
Enclosed